



850 **Le Mans**

**ADDITIONS AND CHANGES TO THE WORKSHOP
MANUAL FOR V 7 SPORT - 750 S - 850 T**

MAIN FEATURES

Engine

Cylinder disposition	2-cylinder, 4-stroke «V» 90°
Bore	mm 83
Stroke	mm 78
Displacement	cc 844
Compression ratio	10,2
Output	HP 80 SAE at 7300 rpm

VALVE GEAR

O.H.V. push rod operated.

CARBURETION

2 Dell'Orto Carburetors type PHF 36B (D) right PHF 36B (S) left.

LUBRICATION

Pressure, by gear pump.
Normal lubrication pressure, $3,8 \div 4,2$ Kp/cm² (controlled by relief valve).
Wire gauze and cartridge oil filters.
Electrically controlled oil pressure gauge.

GENERATOR

(14 V - 20 A) Front on the crankshaft.

IGNITION

By battery, with double contact breaker and automatic advance.
Ignition data:
Initial advance (fixed) 8°
Automatic advance 26°
Full advance 34°
Contact breaker point gap mm $0,37 \div 0,43$
n. 2 spark plugs
n. 2 ignition coils, on the left side of frame.

STARTING

Electric starter with electromagnetic ratchet control. Ring gear bolted on flywheel.
Starter button (START) right on the handlebar.

TRANSMISSION

Clutch: Dry type, multiplates. Lever controlled from the L/H side of the handlebar.
Primary drive: via the gearbox
ratio: 1 : 1,235 (Z = 17/21).
Gearbox: Five speeds. Frontal engagement, constant mesh gears Cush drive incorporated. Pedal controlled from the L/H side of the motorcycle.

Ratio:

low gear	1 : 2	(Z = 14/28)
2nd gear	1 : 3,388	(Z = 18/25)
3rd gear	1 : 1,047	(Z = 21/22)
4th gear	1 : 0,869	(Z = 23/20)
5th gear	1 : 0,750	(Z = 28/21)

Secondary Drive: cardan shaft (bevel gear set)
ratio: 1 : 4,714 (Z = 7/33)
Overall gear ratio (engine/wheel)

low gear	1 : 11,643
2nd gear	1 : 8,080
3rd gear	1 : 6,095
4th gear	1 : 5,059
top gear	1 : 4,366

CYCLE

Frame: Duplex cradle, tubular structure.

Suspension: Telescopic front fork incorporating sealed hydraulic dampers.
Rear swinging fork with externally adjustable springs.

Wheels: in light alloy with rims
WM 3/2,15 - 18" front and rear.

Tyres:

Front	3,50 H - 18"	or	100/90 H - 18"
Rear	4,00 H - 18"	or	110/90 H - 18"
			or 4,10 V - 18"

Brakes:

Front: Hydraulic disc brake, twin braking cylinder caliper. Hand lever controlled from the R/H side of the handlebar. Hydraulic transmission free from rear braking system.

Disc	Ø 300 mm
Braking cyl.	Ø 38 mm
Master cyl.	Ø 12,7 mm

Rear: Hydraulic disc brake, twin braking cylinder caliper. Pedal lever controlled from the R/H side of the motorcycle.

Disc	Ø 242 mm
Braking cyl.	Ø 38 mm
Master cyl.	Ø 15,875 mm

The rear brake is bound by a hydraulic transmission to a twin front brake featured and dimensioned like the hand controlled one.

Dimensions and weights

Wheelbase (under load)	m 1,470
Max. length	m 2,190
Max. width	m 0,720
Max. height	m 1,030
Min. ground clearance	m 0,150
Dry weight	kg 198

PERFORMANCES

Max. speed, solo	210 km/h
Fuel consumption	lt 8 x 100 km

FUEL AND OIL CAPACITIES

GROUP OR PART	QUANTITIES	RECOMMENDATION
Fuel Tank (Reserve 3 lt)	lt 22,5	Petrol 98/100 NO-RM
Sump	lt 3	Agip SINT 2000 SAE 10 W/50
Gearbox	lt 0,750	Agip F. 1 Rotra MP SAE 90
Rear drive box (bevel set lubrication)	{ lt 0,230	Agip F. 1 Rotra MP SAE 90
	{ lt 0,020	Agip Rocol ASO/R
Front fork (p. leg)	lt 0,120	Agip F. 1 Dexron
Front and rear brakes		Agip F. 1 Brake Fluid SAE - J 1703

ENGINE INSPECTION AND OVERHAULING

Cylinder head covers - Cylinder heads - Valves - Springs - Valve guides

To take the valve guides off the cylinder heads use the proper punch (see fig. 22). The valve guides are to be replaced when the clearance between valve and valve guide is not avoided by replacing the valves only.

To press the valve guides onto the cylinder heads use the proper punch (see fig. 23). Heat first the cylinder heads and lubricate the valve

guides. The valve guides pressed, ream properly the inner bores (where the valve stems slide) using a proper tool in such a way to bring the inner \varnothing at the exact measure and data which are given in the table hereunder (see Drwg. fig. 348). The negative clearance between valve guides and cylinder heads must be within mm $0,046 \div 0,075$.

COUPLING DATA BETWEEN VALVE AND VALVE GUIDES (see Drwg. fig. 348)

VALVE GUIDE INNER \varnothing	VALVE STEM \varnothing	ASSEMBLING CLEARANCE
Inlet 8,000 \div 8,022	7,972 \div 7,987	0,013 \div 0,050
Outlet	7,965 \div 7,980	0,020 \div 0,057

Valve seats

The valve seats have to be reground with a proper grinder to provide a good coupling with valves. The valve seat inclination angle is $45^{\circ}30' \pm 5$.

Valves (see Drwg. fig. 348)

Ensure the clearance between valve stem and valve guide is within the right limits. The inclination angle of the valve plate is $45^{\circ}30' \pm 5$. The plate \varnothing of inlet valve is 44 mm while the plate \varnothing of outlet valve is $37,000 \div 37,100$ mm.

CYLINDERS - PISTONS - PISTON RINGS

Cylinders (see Drwg. fig. 349)

Inspection

Measure the cylinder bore at the top, middle and

bottom on both transversal and longitudinal directions. In case off limits of values re-bore the cylinder considering that pistons and piston rings are available with the following oversizes: 4/10 and 6/10.

CYLINDER \emptyset

STANDARD VALUE	4/10 oversize	6/10 oversize
83,000 \div 83,018	83,400 \div 83,418	83,600 \div 83,618

SELECTION OF CYLINDER \emptyset

CLASS «A»	CLASS «B»
83,000 \div 83,009	83,009 \div 83,018

Note: Class «A» cylinders must be matched with class «A» pistons; the same for class «B» cylinders and pistons.

Pistons (see Drwgs. fig. 349-350)

At the time the engine is overhauled, clean the

piston crown and the piston ring slots of all carbon deposits. Check then the clearance between cylinders and pistons relating to \emptyset selection. If such clearance is over the table values, it will be necessary to re-bore the cylinder considering that the piston is available with the following oversize: 4/10 and 6/10.

Pistons must be balanced; a weight difference of 1,5 gr is allowed. The selection measure must be taken at 22 mm from the piston bottom. (see Drwg. fig. 349 and Selection Table).

When fitting a piston pay attention that both the piston selection mark and the wording «SCA» (exhaust) face the cylinder exhaust hole.

PISTON \emptyset

	$\emptyset \cdot P \cdot$ mm	$\emptyset \cdot N \cdot$ mm	$\emptyset \cdot O \cdot$ mm
standard value	74.400 \div 74.600	82.000 \div 82.200	82.936 \div 82.954
4/10 oversize	74.800 \div 75.000	82.400 \div 82.600	83.336 \div 83.354
6/10 oversize	75.000 \div 75.200	82.600 \div 82.800	83.536 \div 83.554

PISTON \emptyset SELECTION

CLASS «A»	CLASS «B»
82,936 \div 82,945	82,945 \div 82,954

Note: Class «A» piston must be matched with class «A» cylinders; the same for class «B» pistons and cylinders.

Fitting of a piston onto a con-rod

Before fitting a piston on to a con-rod, it is necessary to heat it in oven in oil bath at about 60 °C; this will allow a light dilatation of piston holes, thus making the introduction of the piston pin easier.

COUPLING DATA BETWEEN PISTON PIN AND PISTON HOLES (see Drwg. fig. 350)

PISTON RINGS

Each piston fits three types of pistons rings:

1 - Upper seal ring

standard \emptyset	mm 83,000
4/10 oversize	mm 83,400
6/10 oversize	mm 83,600
ring thickness	mm 1,490 \div 1,478
ring gap	mm 0,30 \div 0,45
slot clearance	mm 0,30 \div 0,62

2 - Middle seal ring, step oil scraper

standard \emptyset	mm 83,000
4/10 oversize	mm 83,400
6/10 oversize	mm 83,600
ring thickness	mm 1,490 \div 1,478
ring gap	mm 0,30 \div 0,45
slot clearance	mm 0,30 \div 0,062

3 - Oil scraper ring

standard \emptyset	mm 83,000
4/10 oversize	mm 83,400
6/10 oversize	mm 83,600
ring thickness	mm 3,900 \div 3,878
ring gap	mm 0,25 \div 0,40
slot clearance	mm 0,042 \div 0,060

CON-RODS = CRANKSHAFT

Con-rods (see Drwgs. fig. 351-532)

Loading torque for con-rod cap securing nuts:
4,6 ÷ 4,8 kpm.
Allowed con-rod weight imbalance: gr 3.

CON-ROD SELECTION

CLASS «A»	CLASS «B»
«Blue» mark on the rod 47,130 ÷ 47,136	«White» mark on the rod 47,136 ÷ 47,142

CRANKSHAFT (see Drwg. fig. 353)

CRANKPIN Ø STANDARD VALUE	BEARING UNDERSIZES		
	0,254	0,508	0,762
44,008 ÷ 44,020	43,754 ÷ 43,766	43,500 ÷ 43,512	43,246 ÷ 43,258

CRANKSHAFT SELECTION

CLASS «A»	CLASS «B»
«Blue» mark on the shoulder, flywheel side 44,008 ÷ 44,014	«White» mark on the shoulder flywheel side 44,015 ÷ 44,020

Clearance between crankpin and bearing: Min. 0,030 Max. 0,054.

Inspecting the crankshaft balance

Static balancing of the crankshaft is obtained by applying a weight of kg 1,586 ÷ 1,616 onto the pin.

VALVE GEARING

Timing data

Timing data (referred to the clearance of 1,5 mm between rocker and valve) are the following (see fig. 260).

Inlet:

- opens 20° before T.D.C.
- closes 52° after B.D.C.

Outlet:

- opens 52° before B.D.C.
- closes 20° after T.D.C.

Working clearance on a cold engine: mm 0,22.

Ø OF CAMSHAFT BEARING AND HOUSINGS IN CRANKCASE

	CAMSHAFT BEARING	HOUSING IN CRANKCASE	FITTING CLEARANCE
Valve gearing side	47,000 ÷ 46,984	47,025 ÷ 47,050	0,025 ÷ 0,066
Flywheel side	32,000 ÷ 31,984	32,025 ÷ 32,050	

COUPLING DATA OF TAPPETS AND GUIDES ON CRANKCASE

	I/D OF GUIDE	O/D OF TAPPET	FITTING CLEARANCE
Original	22,021 ÷ 22,000	21,996 ÷ 21,978	0,004 ÷ 0,043
0,05 mm oversize	22,071 ÷ 22,050	22,046 ÷ 22,028	0,004 ÷ 0,043
0,10 mm oversize	22,121 ÷ 22,100	22,096 ÷ 22,078	0,004 ÷ 0,043

FITTING OF CAMSHAFT ASS. Y,

After fitting the oil pump and the chain tensioner proceed as follows:

— Fit the camshaft «A» fig. 261 into the crankcase housings and secure it to the crankcase using flange «B» fig. 261 then lock the screws with toothed washers «C» fig. 261.

— Fit the gears with mounted chain «D» fig. 261 onto: camshaft, crankshaft and oil pump control shaft, paying attention to the alignment of the reference marks «E» fig. 261 indicating that the engine is timed (valve gearing); then fit the stop pin «F» fig. 261 into the holes of gear «G» fig. 261 and camshaft «H»; pay attention also to the key hollow on the engine pinion «I» fig. 261.

— Lock the nut with toothed washer «M» fig. 261 securing the gear to the camshaft, using holdfast tool n. 14 92 73 00 (20 fig. 262) and wrench 18 92 76 50 (60 fig. 262) for the nut 27 or wrench 14 92 76 00 for the nut 26.

— Lock the ring with washer «M» fig. 261 securing engine pinion to the crankshaft, using holdfast tool 14 92 73 00 (fig. 263) and special wrench 18 92 76 50 (60 fig. 263) bend then one washer wing into a ring hollow.

— Lock the nut with spring washer «N» fig. 261

securing the gear to the oil pump control shaft (remember to fit the key «O» fig. 261 onto the shaft) using holdfast tool 14 92 73 00 and special eye wrench.

The group fitted and nuts and ring locked, remember to check the proper alignment of the reference marks on camwheel and engine pinion «A» fig. 264 and to fit the tappets «Q» fig. 261 into the guides on crankcase «P» fig. 261.

Checking the valve timing with engine installed on vehicle

Proceed as follows:

- Remove the spark plugs.
- Remove the rocker box covers.
- Set a clearance of 1,5 mm between rocker and valve.
- Undo the screws and remove the alternator cover.
- Remove the rubber cover from the inspection hole on the R/H side of the gearbox.
- Using a proper tool, turn the alternator so as to bring the right piston to T.D.C. (closed valves); observe that the mark «D» appears in the middle of the inspection hole.

— Fit the tool with arrow 14 92 75 00 (26 fig. 64) onto the valve gearing cover and lock it by means of a screw.

— Undo the bolt securing alternator to crankshaft, align the mark PMS (T.D.C.) with the tool arrow then fit the degree plate 14 92 74 00 (25 fig. 64) onto the alternator itself, secure then degree plate and alternator to the crankshaft by means of the screw.

— Check through the inspection hole that the reference mark «D» is always aligned with the mark in the center of the hole rim.

— Rotate the alternator (with degree plate) 128°

clockwise, starting from the mark «PMS» (T.D.C.) in line with the tool arrow.

At this stage, under normal conditions, the exhaust valve of right cylinder must start opening.

After this checking and provided everything is normal, it is necessary to re-set the working clearance between rocker and valve at 0,22 mm.

Then fit the rocker box covers, securing them by means of proper screws and the rubber cover onto the gearbox inspection hole. Remove the arrow tool and the degree plate, lock the bolt securing alternator to crankshaft, re-fit the alternator cover onto the valve gearing cover and the spark plugs.

LUBRICATIONS

ENGINE LUBRICATION

Description

This type of engine fits an oil filter which, in addition to a wire gauze filter, is provided also with a cartridge filter (to be replaced every 15000 km about). This ensures an almost integral filtering before the oil passes in the pump and lubricating channels.

Oil Sump (see fig. 218)

The oil sump fits:

- A - Filter cartridge, replaceable.
- B - Magnetic oil drain plug.
- D - Wire gauze filter.
- E - Oil pressure relief valve.

Checking the oil level in the engine (see fig. 354)

Every 500 km check the oil level in the crankcase (it must be nearly at the max. mark stamped on the cap filler dipstick «A»).

In case of lower level, fill with oil having recommended features.

Check the oil level after the engine has run for a few minutes and fully screw the cap filler dipstick «A».

Changing the oil (see fig. 354)

After the first 500 ÷ 1.000 km and later on every 3.000 km change the engine oil. The oil has to be replaced **when the engine is warm**. Allow all the old oil to drain before introducing fresh oil.

«A» oil filler cap.

«B» oil drain plug.

Required Q.ty: lt 3 of oil AGIP SINT 2000 SAE 10 W/50.

Replacing the filter cartridge (see fig. 218)

Every 15.000 km (five oil changes) replace the filter cartridge «A» proceeding as follows:

— Undo the drain plug «B» and let the oil drain from the sump.

— Undo the securing screws and remove the sump «C» from the crankcase, using a nylon hammer. The sump fits: the filter cartridge «A», the wire gauze «D» and the oil pressure relief valve «E».

— Unscrew the filter cartridge «A» from the sump «C» and replace it by an original one. It is advisable to wash the wire gauze filter «D» too.

By re-fitting the sump onto the crankcase remember to replace also the gasket between sump and crankcase.

Wire gauze filter (see fig. 218)

The wire gauze filter «D» is secured to the sump «C» by means of a bolt with a securing plate. When replacing the filter cartridge «A» it is advisable to remove also the filter «D» to wash it in gasoline and blow it out with compressed air.

Oil pressure relief valve (see fig. 218)

The oil pressure relief valve «E» is screwed on the sump «C». It is calibrated to allow a pressure of $3,8 \div 4,2$ kp/cm².

In case of higher pressure, this valve opens thus adjusting the pressure to the correct limits. Should the calibration be higher or lower, adjust the valve in such a way that it opens exactly at the correct pressure. This is done by removing one or more shims over the spring if calibration is higher or by adding one or more shims over the spring if calibration is lower.

GEARBOX LUBRICATION (see fig. 84)

Checking the oil level

Every 3.000 km check that the oil level is nearly at the inspection hole «B». In case of lower level fill with oil of recommended features.

Changing the oil

Every 10.000 km or so change the oil in the gear box.

This operation has to be carried out when the oil is still warm and easy to drain. Let all the old oil to drain before introducing fresh oil.

«A» oil filler cap.

«B» level inspection plug.

«C» drain plug.

Required Q.ty: lt 0,750 of oil Agip F. 1 Rotra MP SAE 90.

REAR DRIVE BOX LUBRICATION (see fig. 355)

Checking the oil level

Every 3.000 km check that the oil level is nearly at the inspection hole «A». In case of lower level fill oil of recommended features.

Changing the oil

Every 10.000 km or so change the oil in the rear drive box. This operation has to be carried out when the oil is still warm and easy to drain. Let all the old oil to drain before introducing fresh oil.

- «A» level inspection plug.
- «B» oil filler cap.
- «C» oil drain plug.

Required Q.ty: lt 0,230 oil Agip F. 1 Rotra MP SAE 90.
lt 0,020 oil Agip Rocol ASO/R.

FRONT FORK LUBRICATION (see fig. 356)

To replace the lubricating oil in the fork covers proceed as follows:

- Undo the drain plugs «A» with gasket.
- Undo the screws «B» on the fork arms.

Before introducing fresh oil, let all the old oil to drain.

- «A» oil drain plug.
- «B» oil filling screw.

Required Q.ty: lt 0,120 of Oil Agip F. 1 ATF Dexron each cover.

LUBRICATION OF STEERING BEARINGS AND REAR FORK

In case of general overhauling, it will be advisable take the conical bearings off steering and rear swinging fork. Check their condition and lubricate them with Agip F. 1 grease 30.

CHECKING OIL LEAKAGE BETWEEN GEARBOX AND ENGINE

To detect oil leakages proceed as follows:

— First ascertain if the oil leaking outside come from the gearbox or from the engine unit. This is quite easy to do by smelling the oil itself. As a matter of fact the oil coming from the gearbox smells bad and is more viscous (if checking is done with a cold group) while the oil coming from the engine unit is less viscous and does not smell.

If the oil comes from the gearbox, the leakage may be caused by the following:

- 1 Poor sealing between clutch pressure plate rod and intermediate tube in the clutch shaft; see if the rod is very oily and slides freely into the clutch shaft (to ensure a proper sealing the rod must force on the tube and this must force on the clutch shaft). In this case it is advisable to check that the clutch plates are not oily.
- 2 Poor sealing of the ring mounted on the gearbox, flywheel side. Check ring resilience and wearing and see if there is an oil drop under the ring itself. Should it be worn out, check the surface of the clutch inner body contacting the ring.

This surface must not be rough and must not show any crush or score.

3 If the clutch inner body contains oil inside (where the nut with washer securing clutch inner body to clutch shaft is locked) check if the two sealing rings on clutch inner body and clutch shaft have not lost resilience and efficiency.

4 Porosity in the gearbox. To check this operate as follows:

— Set the gearbox onto a bench, the clutch housing side upwards (fig. 123).

— Fill the clutch housing side with water and blow compressed air at 4 kp/cm² through the breather tube «B» (fig. 123). In case of casting porosity small bubbles will be visible in the water.

Seal by means of latex or special plasters «Araldite or Devcon».

If the clutch slides because of oil leakages between engine and gearbox and the oil passes between the clutch pressure plate rod and the intermediate tube and it is ascertained that the oil comes out from the engine crankcase, this may be caused by the following:

5 Oil leaking through the seal ring mounted on the crankcase flange. Check ring resilience and wearing; if worn out, inspect the crankcase surface contacting the ring itself. This surface must be perfectly smooth.

6 Eventual porosity in the engine crankcase. For this checking set the engine onto a bench, the flywheel side upwards (see fig. 122) - remove first the flywheel from the engine — and fill with water. Blow compressed air at 4 kp/cm² through the breather tube «A» (fig. 122). In case of casting porosity, small bubbles will be visible in the water. Seal by means of latex or special plasters «Araldite» or «Devcon».

7 If the bands securing the rubber tubes of the engine oil breather are slackened, the oil may flow between rubber and metal tubes and go between gearbox and engine.

8 See if the two lower bolts securing the flange, flywheel side, to the engine crankcase are dry; should they be oily, set some «Teflon» tape on the bolt thread.

9 See that the lower stud bolt securing gearbox to engine, left side, is not oily where the reference bushing is located; otherwise set some Teflon tape on the stud bolt thread.

OIL LEAKAGE FROM THE REAR DRIVE BOX

For this checking operate as follows:

— Fit the tool «C» (fig. 124) onto the rear drive box. (This tool can be obtained from a used rear fork right arm by welding a plate with a valve, tyre inner tube type, on the arm top).

— Set the drive box into a small basin filled with water and blow compressed air at 4 kp/cm² through the valve of tool «C» (fig. 124). In case of casting porosity, small bubbles will be visible in the water. Seal by means of latex or special plasters «Araldite» or «Devcon». Check also that there is no oil leaking between drive box and lower pin securing the rear fork. If the pin is oily, set some «Teflon» tape on the pin thread.

CARBURETION

CARBURETTORS (see fig. 357)

n. 2 Dell'Orto PHF 36 B (D) right - PHF 36 B (S) left.

Controls

— Throttle control twist grip on the R/H side of the handlebar.

— Starter control lever for starting a **cold engine** located on the rocker box cover of left cylinder. «A» starting position - **cold engine**.

«B» riding position.

Note: With lever in position «B» ensure that there is a play of about 3 mm between the «starter» control cable ends and the cable adjuster screws «E» on both carburetors.

Standard carburettor setting

Choke	Ø mm 36
Throttle (3)	60
Atomizer	265 AB
Main jet	135
Idling jet	60
Starter jet	70
Pump jet	38
Needle	K 5 (2nd. notch)
Floater	gr 10
Opening of idling adjuster screw	1 turn and a half

FLOATER LEVELLING (see fig. 268/1)

To level the floaters in carburetors proceed as follows:

- 1 Loosen the screws securing the bottom chamber to the carburettor body and take out the chamber itself.
- 2 Turn the carburettor upside down (without bottom chamber) so that the needle on the floater body closes the petrol flow in.
- 3 Place the tool 14 92 69 00 (72 in fig. 236) on the plane of the carburettor body (where the bottom chamber is screwed to) and make sure that the two floaters lightly touch the tool inside.
Otherwise adjust either the floater pin or the floaters themselves (paying attention that these are very brittle parts) until the floaters are properly aligned with the tool. The clearance between the carburettor body plane and the floater upper side has to be:

— mm 23,5 (for carburetors having 10 gr floaters).

Adjusting carburetion and idling speed (fig. 357)

Should a proper «Vacuum Meter» not be available, this adjustment is made as follows:

- 1 Warm the engine at its running temperature.
- 2 Screw idling adjusting screws «C» (fuel) fully in, then screw them out by one turn and a half.
- 3 By means of your hands feel if pressure at exhaust outlets is the same. In case of differences, act on screw «D» of one carburettor to equalize such pressure. (Idling speed will have to be kept at 1.000 ÷ 1.100 r.p.m. consequently it will be necessary either to screw in the carburettor screw of the cylinder having a lower pressure or to screw out the carburettor screw of the cylinder having a higher pressure).
- 4 Get the best carburetion for each cylinder by acting on screws «C» (this will be at the point where the r.p.m. slightly increase), then get idling speed according to point 3.
- 5 Disconnect one spark plug lead at a time and check that the engine stops after firing the same number of strokes. If this does not occur, proceed as follows:
— screw out the carburettor screw «D» of the cylinder causing the engine firing a higher number of strokes;
— screw in the carburettor screw «D» of the cylinder causing the engine firing a lower number of strokes.
- 6 Adjust idling speed to 1.000 ÷ 1.100 r.p.m. by screwing in or out in the same quantity both screws «D».

7 After closing the throttle control twist grip check that there is a clearance of 1 ÷ 1,5 mm between cable ends and adjuster screw «A», handlebar side, otherwise loosen nuts «B» and screw in or out adjuster «A». Afterwards lock the nuts «B» (fig. 358).

- 8 Check that both throttles open at the same time by proceeding as follows:
— Turn slowly the throttle control twist grip and check with both hands that the pressure at exhaust outlets increases simultaneously. In case such increase is not simultaneous, adjust the carburetion of the cylinder in advance by screwing adjuster «A» in (after loosening counter-nut «B» (fig. 358) until the pressure is the same for both outlets.

ADJUSTING THE CARBURETION BY MEANS OF A «VACUUM METER» (see fig. 357)

- 1 **Adjusting idling screws (fuel):** through screws «C», screwing these in reduces the fuel flow while screwing these out increases the fuel flow. To adjust drive screws fully home then unscrew for one turn and a half for both carburetors.

2 Remove the caps «F» from intake tubes and fit there the pipes of the «Vacuum Meter».

3 Adjusting idling speed by acting on throttles (with a warm engine): Start the engine with the throttle control twist grip min. opened (1.000 ÷ ÷ 1.100 r.p.m.). Acting on the throttle adjuster screws «D» check the alignment of the two mercury columns of the «Vacuum Meter» control panel; otherwise get such alignment through screws «D».

4 Adjust the position of the screws «D» to obtain the highest possible r.p.m. rate. Re-check then the position of the mercury columns of the «Vacuum meter» If necessary repeat the operation under point 3.

5 Synchronizing the carburetors.

After adjusting the idling speed, synchronize the carburetors by proceeding as follows:

— Start the engine and gradually open the throttle control twist grip paying attention to the

alignment of the mercury columns on the «Vacuum Meter»; otherwise align them acting on the adjuster screws on throttle control cables «A», after loosening conternuts «B» fig. 358. After this checking ensure that the two cables at inserting the screws «A» fig. 358 have a play of 1 ÷ 1,5 mm.

This checking carried out, remove the «Vacuum Meter» pipes and re-fit the caps «F» fig. 357 with washers.

Ensure also that the two control cables of «Starter» devices have a free play of about 3 mm at inserting the adjuster screws «E» fig. 357. (Starter control lever in riding position «B» fig. 357).

Adjusting the throttle control twist grip

(see fig. 358)

To adjust the grip travel act on screw «C» after loosening conternut «D» To adjust the grip return act on screw «E».

GEARBOX

The gearbox is a separate unit bolted to the engine block and incorporates constant mesh gears with frontal engagement. It is pedal lever controlled from the L/H side of the vehicle.

Five speeds (see fig. 358/1): 1st. speed lever down, other speeds lever up.

Engine gearbox ratio: 1 : 1,235 (Z = 17/21)

Internal gear ratios:

1st speed	1 : 2	(Z = 14/28)
2nd speed	1 : 1,388	(Z = 18/25)
3rd speed	1 : 1,047	(Z = 21/22)
4th speed	1 : 0,869	(Z = 23/20)
5th speed	1 : 0,750	(Z = 28/21)

REAR DRIVE BOX

Shaft with double cardan joint and gears.

Ratio 1 : 4,714 (Z = 7/33)

Overall ratio (engine-wheel)

1st speed	1 : 11,643
2nd speed	1 : 8,080
3rd speed	1 : 6,095
4th speed	1 : 5,059
5th speed	1 : 4,366

Stripping the rear drive box (fig. 304)

First drain the oil by removing the drain screw with Al. washer «C», the filling screw with Al. washer «B» and the level inspection screw with Al. washer «A».

— Undo the screws securing rear drive box to rear swinging fork arm and take off the rear drive box with the gasket (OR type) «D».

— From the drive box remove the housing with pinion «E» and gasket (OR type) «F».

— Flatten the wings of the securing plates then undo the screws «G» securing cover «H» to box «I».

— Remove the cover «H», the gaskets «L» with shim «M».

— From the drive box remove the pierced pin «N» complete with crown.

— From the drive box remove spacer «O» sealing ring «P» and roller bearing «Q».

Stripping the housing

To remove the nut securing pinion to housing use holdfast tool 18 92 71 50 (65 fig. 305) and eye wrench; after undoing the nut take the following off the housing:

- bevel pinion with shims;
- bevel bearings;
- spacer between bearings;
- shimw between bearing and spacer;
- bare housing.

Selection of crown-pinion ass.y

Pinion and crown have to bear the same number. (see «A» & «B» fig. 306).

Assembling the housing

Reverse the stripping sequence. If no part has been replaced, ensure that the shim number between spacer and bearing as well as between bearing and pinion is the same. In case of eventual replacement of parts, it will be necessary to adjust this shimming.

The nut has to be locked using holdfast tool 18 92 71 50 (65 fig. 305) and eye wrench.

Fitting the housing onto the drive box

(see fig. 358/2)

In fitting the housing «A» onto the rear drive box «B» pay attention to the alignment of the lubrication holes («C» for drive box - «D» for housing); also remember to fit the sealing ring «E» (OR type) between housing and drive box.

Crown Pinion matching (see fig. 307)

Make sure that the plane made by the gears couple is in perfect corespondence by proceeding as follows:

— Secure the housing to the drive box using two nuts «A» and washers.

— Smear the crown teeth with lead oxide.

— Rotate the pinion, keeping the crown braked, so that such rotation takes place under load leaving a contact trace on the crown painted surface. If this contact is normal, the pinion teeth trace on the crown will be even along the whole tooth flank.

Also ensure that the pinion tothing is $1 \div 2$ mm longer than the crown one (see arrow «B»).

Fitting the cover onto the drive box

(see fig. 308)

Proceed as follows:

— Fit the gasket «A» onto the drive box, then fit the shim «B» and the other gasket «A», paying attention to the alignment of the holes with the ones on the drive box.

The cover has to be fitted onto the drive box paying attention that the wording «Basso» (C) is downwards and caring for the alignment of the arrow on the cover «B» with the arrow «E» on the drive box, then screw in fully but without locking.

Checking the clearance between crown and pinion (fig. 309)

Proceed as follows:

- Insert the legs of a universal puller «A» and connect them inside the ass. y crown drillen pin.
- Fit also a piece in light alloy «B» and screw the puller on this piece.
- Using one hand rotate the pinion «C», the other hand will draw and release the tool «A» in such a way as to make sure the clearance is normal. If the clearance is not normal, it is necessary to replace the shim «B» (fig. 130) with a higher or lower one to bring clearance to normal tolerance.

The shims are available in various sizes:

- n. 17 35 54 00 mm 0,8
- n. 17 35 54 02 mm 0,9
- n. 17 35 54 04 mm 1
- n. 17 35 54 06 mm 1,1
- n. 17 35 54 08 mm 1,2
- n. 17 35 54 10 mm 1,3

Fitting the rear drive box onto the rear swinging fork right arm

Proceed as follows:

- After fitting the sleeve and the shaft onto the pinion, fit the sealing ring onto the housing «G» fig. 368/2, then fit the rear drive box (complete with shaft) onto the double cardan joint then fit the four stud bolts of the drive box into the holes of the right arm of rear swinging fork «A» fig. 310.
- Fit the wheel spindle «B» fig. 310 onto the left arm of rear swinging fork and onto the drive box.
- Lock the nuts «C» in fig. 310 with their washers. The nuts locked, slide out the wheel spindle «B» paying attention that it must slide without any forcing.
If a certain resistance is found in sliding the spindle, it is necessary to slacken the nuts «C» then to turn the drive box to the right or to the left until the spindle can be slid out without any forcing.

REAR SWINGING FORK

Overhauling

Inspect the rear swinging fork for abnormal bending or cracking at welded points and check the smoothness of the connecting surface to the rear drive box. For size inspection see Drwg. 311.

Removal of bearings from the rear swinging fork

The cardan joint bearing is removed using puller 18 92 72 50 (66 in fig. 132) the rear swinging

fork pin bearings are removed using puller 12 90 47 00 (14 in fig. 125).

Adjusting the play of the rear swinging fork (fig. 313)

The rear swinging fork has to swing freely without any play.

Pay attention that, for proper adjustment, the pins must extend the same length.

For this adjustment use a screw driver «A» and a gauge «B».

REAR SUSPENSION

The vehicle fits two rear shock absorbers with hydraulic dampers adjustable to three positions, using the proper wrench in the tool kit (see fig. 357). In case of improper damper action, return them to the manufacturer for overhauling. The various position sizes are shown in Drwg. 359.

Spring features (see fig. 360)

Free length		mm 279 ÷ 281,5
Length under kg 52 load		mm 236 ÷ 238,5
Length under kg 103 load		mm 196 ÷ 198,5
Length under kg 145 load		mm 167 ÷ 169,5
Length under kg 232 load		mm 120 ÷ 122,5

In case of different findings, or spring distortion replace the springs.

WHEELS AND BRAKES

Removal of the front wheel from the fork legs (fig. 361)

Proceed as follows:

- Fit the stand 14 91 24 50 under the engine sump, the side holding the gearbox must face the front wheel, then screw in the stand in such a way as to lift the vehicle.
 - Loosen the screws securing the caliper «A» to the front fork left leg.
 - Undo the nut «B» on the wheel spindle, left side.
 - Undo the screws «C» securing spindle to fork covers.
 - Slide out the spindle «D» from fork covers and wheel hub, then take the wheel off right caliper and fork covers.
- In re-fitting reverse the sequence, remember to fit the spacer «E» between wheel hub and front fork left cover.

Removal of the rear wheel from the rear drive box and the left arm of the rear swinging fork (see fig. 362)

Proceed as follows:

- Set the vehicle on the center stand.
- Undo the nut «E» on the wheel spindle, rear drive box side.
- Undo the screw securing the spindle on the rear swinging fork arm.
- Take the spindle «D» off rear drive box, wheel hub and rear swinging fork arm.
- Take the braking disc off caliper «E».
- Remove the brake caliper ass.y and secure it to the frame.

— Lean the vehicle to the right side to take the wheel «F» off rear swinging fork arm and rear drive box.

In re-fitting reverse the sequence paying attention to fit the caliper ass.y onto the rear swinging fork left arm.

Truing the braking disc between the brake pads (fig. 322)

To correctly true the braking disc between the braking pads «A» it is necessary to increase or decrease the shim quantity on the screws «B» securing the caliper to:

- Front fork left cover.
 - Front fork right cover.
 - Rear wheel caliper bracket
- until the disc is correctly trued between the pads.
- The shims are available in the following thicknesses:
- partn. 95 10 02 32 mm 0,5
 - partn. 95 10 02 33 mm 0,8.

Replacing the braking pads in calipers (fig. 314)

For this replacement it is necessary to remove the hole cover «A», then to take off the pad retainer pins «B», the positioning spring «C» and the pin «D»; then replace the pads «E». The pads replaced, it is necessary to operate several times the hand control lever or the foot control pedal until the pads properly couple the discs.

MAINTENANCE AND ADJUSTMENTS

Adjusting the clutch control lever (fig. 363)

If the free play at the handlebar is higher or lower than 4 mm screw in or out adjuster «4» to obtain the correct play.

This adjustment can also be done by slackening nuts «C» and acting on adjuster «B» on the R/H side of the gearbox.

Adjusting the front brake control lever (fig. 364)

Proceed as follows:

— set a feeler gauge «A» between lever and float in master cylinder, then act on screw «B». Specified play is: 0,05 - 0,15 mm.

Checking the brake pad wearing

Every 500 km check the brake pad thickness:

— wear limit mm 6 about
— new pad mm 9

If the thickness is under the wear limit, it is necessary to replace the pads.

After this operation has been carried out, do not bleed the air from the braking circuit but only operate the lever «B» fig. 365 several times until the caliper pistons reach their normal position. By the replacement of pads check also the conditions of the fluid pipes and replace them immediately in case of damage.

Checking the brake discs «I» fig. 365 and 366

The brake disc must be accurately clean, without oil, fat or other dirt and must not show any deep scoring.

In case of replacement or overhauling of the brake disc, it is necessary to check its wobbling. This checking is carried out by means of a proper gauge that must not read more than 0,2 mm.

Should the measurement be higher, carefully check the mounting condition of the disc on the hub and the play of bearings on the hub itself. The loading torque of the screws securing disc to hub is $2,2 \div 2,4$ Kpm.

Checking the fluid level and changing the fluid in reservoirs (fig. 365-366)

For a good working of brakes, these directions are to be followed:

1. Periodically check the fluid level which has to be at the transparent part «C» of the fluid reservoir «A». Such level must never fall under this transparent part.
2. periodically (or whenever necessary) top up in the fluid reservoir «A» after loosening the cap «D» and taking off the rubber gaiter.

The minimum fluid level in the reservoir for front left and rear brake is warned by a warning light «8» in fig. 372 which is located on the instrument panel and actuated by cutout «C» (fig. 366).

Topping up in this reservoir is made possible by unscrewing the cap «D» of reservoir «A» fig. 366 after detaching the electric wiring.

For topping up use fresh fluid taken from sealed containers to be opened only by use.

3. Completely renew the brake fluid every 15000 km or at least once a year.

4. The fluid pipes have to be always full and without air; a long and elastic movement of the control lever «B» evidences the presence of air. No alcohol is to be used for washing and no compressed air for drying up; use trichloroethylene for metallic parts.

Recommended fluid: «AGIP F. 1 Brake Fluid SAE J 1703».

Air bleeding (fig. 365 and 366)

This operation is required when the movement of the control lever is long and elastic because of the presence of air inside the braking circuits. Proceedings are as follows:

Right front braking circuit (fig. 365)

— Turn the handlebar until the master cylinder «A» reaches the horizontal position.

— If necessary, top up in the fluid reservoir «A» (that care that during the air bleeding the fluid level does not fall under the reservoir transparent part.)

— Act on a caliper body «F» at a time.

1 Take out the rubber covers then fit the transparent flexibles pipes «G» on the drain plugs «E»; the other ends of these pipes will be plunged into a transparent container «H» partially filled up with fluid of the same type.

2 Loosen the drain plug «E».

3 Fully operate several times the brake control lever «B» on the handlebar paying attention to release it slowly and wait for a few seconds before operating it again. Repeat this operation until the pipes plunged in the transparent container emit airless fluid.

4 Keep the control lever «B» fully drawn and lock the drain plug «E»; then remove the pipes «G» and fit the rubber covers.

If the air bleeding has been correctly carried out, a direct and efficient working of the fluid will be realized immediately after the initial idle movement of the lever «B»: otherwise repeat the whole operation.

Left front and rear braking circuits (see fig. 366)

See chapters:

Checking the fluid level and changing the fluid in reservoirs except of point 1. which must read as follows:

— It is warned by the warning light «B» fig. 372 on the instrument panel.

When the warning light is lit, it is necessary to top up.

Right front braking circuit except of points 3. and 4. which must read:

— fully operate the control lever pedal «B» ...

— keep the control lever pedal «B» fully pushed down ...

Adjusting the control lever pedal for rear and left front brake (see fig. 367)

Check the play between floater in master cylinder and lever end, then act on adjuster «A». Specified play is $0,05 \div 0,15$.

— Remove circlip, slip out pin and loosen counternut «B», then screw in or out the fork «C» until the ideal position of the control lever pedal is reached; re-fit pin and circlip.

After adjusting, loosen counternut «E» and adjust the stop screw «D».

Adjusting the rear suspension (see fig. 368)

The external springs of the rear suspensions can be adjusted to three positions by means of a proper wrench «A».

In case of faulty damper operation, have them checked by the manufacturers.

Remember that the two springs have to be adjusted to the same position to ensure a good stability of the vehicle.

Adjusting the steering (see fig. 369)

For a safe riding, the steering has to be so ad-

justed to allow a free movement of the handlebar but without excessive play.

— Operate as follows:

— Slacken the steering head fixing bolt «A».

— Loosen the nut securing the steering head «B».

— Screw in or out the adjuster «C» to take up excessive play.

After the adjustment has been done, lock nut «B» and screw «A».

Wheel balance

To improve stability and decrease vibrations at high speeds, the wheels have to be kept balanced.

Operations are as follows:

— Remove the wheel from the vehicle and suspend it on a fork.

— Spin the wheel lightly several times and see if it always stops at various positions, thus indicating a correct balance.

— If one point of the wheel always stops at the bottom, put a proper balance weight opposite that point.

— Repeat this operation until the wheel is correctly balanced.

Tyres

The tyre condition is of main importance as stability of the vehicle, riding comfort and even rider safety are depending on this factor.

It is therefore quite advisable not to use tyres with tread lower than 2 mm.

A wrong tyre pressure can also affect the stability of the vehicle and shorten the tyre life.

Correct pressure is:

— front wheel: solo or with pillion 2 kg/cm²

— rear wheel: solo 2,3 kp/cm²
with pillion 2,5 kp/cm²

These data are for normal riding (touring) in case of constant high speed or highway riding increase tyre pressure by 0,2 kp/cm².

ELECTRIC EQUIPMENT

Battery

Battery is a 12 V type with a capacity of 20 Ah and direct charge from generator.

Access to the battery is made possible by:

- lifting the saddle by means of proper lever;
- removing the tool box;
- unhooking the rubber bands and disconnecting the electric wiring.

Putting a battery into service

1 Fill the battery with chemically pure sulphuric acid, specific gravity 1,28 kg/lt (1,23 in tropic climates) at + 20 °C until the minimum level mark on the battery is reached. At introduction, acid temperature must not be lower than + 10 °C. Do not use metal funnels.

2 Let the battery at rest for about one hour, then top up to the recommended level by adding sulphuric acid. Charge now the battery for 15 hours in CC - Amp. 1,1 Start charging only when temperature is lower than + 40 °C (+ 50 °C in tropic climates).

To charge connect the positive pole (+) of battery to the positive pole (+) of supplier, same connection for the negative poles (-).

During charging, the sulphuric acid temperature must not be higher than + 45 °C (+ 55 °C in tropic climates): otherwise stop charging or reduce the current rate.

The initial charge will be accomplished when the acid density and current intensity rates will remain the same for at least two consecutive hours of charging.

At this point the specific gravity of the sulphuric acid will have to be 1,28 kg/lt \pm 0,01 (1,23 \pm \pm 0,01 in tropic climates) at + 20 °C.

It is to be considered that the specific gravity of the sulphuric acid varies 0,01 for each temperature change of 14 °C.

This means that the specific gravity of an acid at + 34 °C will have to be increased of 0,01 to obtain the specific gravity at + 20 °C.

Two hours after the charge end check the acid level, if necessary top up with chemically pure distilled water. Screw in the filling caps. The battery is now ready to be in service.

Check periodically the electrolyte level, add only distilled water whenever necessary. Ensure that all battery connections are well tight and clean, smear them with neuter vaseline.

ALTERNATOR - GENERATOR

Main Features

Brand	Bosch G1 (R) 14 V 20 A 21 (Bosch code: 0 120 340 002)
Output	280 W - 14 V
Current intensity	20 Amp.
Charge starting	1000 r.p.m.
Peak r.p.m.	10.000
Max. permissible eccentricity	0,06
3-phase winding resistance of stator	3,4 Ohm + 10%
Field winding resistance (AC)	0,36 Ohm + 10%

ALTERNATOR TEST	LOAD	TOP SPEED
Output test (with regulator)	5 A	1300 rpm
	10 A	2100 rpm
	20 A	7000 rpm

ALTERNATOR CHARGING SYSTEM

Inspection on the vehicle

When the warning light indicates something wrong or inconveniences in the charging system it is necessary to carefully inspect the system itself.

A first check is possible without removing the alternator from the motorcycle, but with the engine in sufficient cool condition to allow a safe access to the alternator. Taking proper cautions, detach the cable «B» (red wire, positive rectifier plate) connecting an amperometer or voltmeter according diagram fig. 370.

Start the engine.

Check this connecting on whichever fed device, for example on the headlight, then read charge and relative voltage.

If the reading results in $10 \div 14$ A with 12 or 13 V the alternator working will be considered as regular.

Consequently the trouble cause is to be found elsewhere. Carefully inspect all connections, particularly the warning light circuit and the wiring to regulator and rectifier.

If the troubles persist in spite of having found no defective connection or having repaired the defective ones, proceed to following checking.

Test of a positive diode by means of an «Ohmmeter» (fig. 371)

Connect the Ohmmeter positive point to the diode, anode, then the other Ohmmeter point to the diode cathode; thus bringing the diode to conduction.

The Ohmmeter indicator must firmly shift towards the first sector of the Ohmmeter dial.

By reversing the above point connections, the diode is brought to stopping and the indicator does not move.

For Ohm values, see fig. 372 and 373.

Test of a negative diode by means of an «Ohmmeter»

Connect the Ohmmeter positive point to the diode anode, then the other Ohmmeter point to the diode cathode; thus bringing the diode to conduction. The Ohmmeter indicator must firmly shift towards the first sector of the Ohmmeter dial.

By reversing the above point connections, the diode is brought to stopping and the indicator does not move.

For Ohm values, see fig. 372 and 373.

Test of an exciting diode by means of an «Ohmmeter»

This piece acts as a positive diode.

By connecting the Ohmmeter positive point to the diode anode and the other Ohmmeter point to the diode cathode, the Ohmmeter indicator immediately shift to the first sector of the Ohmmeter dial. By reversing the connection the diode stops and the Ohmmeter indicator does not move.

For Ohm values, see fig. 372 and 373.

In case a defective diode is detected, it will be necessary to replace the whole diode plate.

Test of stator winding resistance (fig. 374)

Detach all the alternator wiring «DB» and «DF» and the pin connection «U - V - W».

This test can be carried out by means of a common «Ohmmeter» or by means of a unit for alternator testing.

The stator winding resistance has to be measured between the phase outlets «U - V — —».

The three measurements shall be equal.

Stator 3-phase winding resistance (A.C.):
 $0,5 \text{ Ohm} \div 10\%$

Test of rotor winding resistance (fig. 375)

By means of an «Ohmmeter», measure the rotor exiting winding resistance with scratched poles. It must result in this value: $4,0 \text{ Ohm} \div 10\%$ (see fig. 375).

By means of an «Ohmmeter», measure the rotor exiting winding resistance with scratched poles. It must result in this value: $4,0 \text{ Ohm} \div 10\%$ (see fig. 375).

After regrinding on a turning machine, check the concentric conditions of commutators (see fig. 376).

Max. permissible excentricity: mm 0,03

Min. commutator \varnothing : mm 31,5

Max. permissible tolerance,
pole wheel: mm 0,05

ALTERNATOR CHARGING SYSTEM FAULTS

In case of faults in current charging systems, remember that the cause is not to be found exclusively in alternator or regulator but also in

battery, electric conductors or others. Hereunder these is a list of most probable fault causes and their remedies.

FAULT CAUSE	REMEDIES
<p>The battery is not charged or insufficiently charged.</p> <ol style="list-style-type: none"> 1. Passage break or resistance in the current charging circuit. 2. Defective battery. 3. Defective alternator. 4. Defective regulator. 	<ol style="list-style-type: none"> 1. Avoid passage break or resistance. 2. Replace. 3. Have it repaired in specific workshop. 4. Replace.
<p>The charge warning light is not lit with engine at stillstand and keyswitch in.</p> <ol style="list-style-type: none"> 1. Warning light bulb burnt. 2. Discharged battery. 3. Defective battery. 4. Slackened or damaged wiring. 5. Defective regulator. 6. Shortcircuit of an alternator positive diode. 7. Worn carbon brushes. 8. Oxidation on contact rings, breaking in the rotor winding. 	<ol style="list-style-type: none"> 1. Replace. 2. Charge by outer electric source. 3. Replace. 4. Replace or tighten. 5. Replace. 6. Have the alternator repaired in specific workshop. 7. Replace. 8. Have the alternator repaired.
<p>The charge warning light is lit with higher rpm rates.</p> <ol style="list-style-type: none"> 1. The conductor D+/61 is grounded. 2. Defective regulator. 3. Defective rectifier, contact rings dirty, presence of C.C. in the DF conductor or in the winding. 	<ol style="list-style-type: none"> 1. Replace or avoid grounding. 2. Replace. 3. Have the alternator repaired in specific workshop.
<p>The charge warning light bulb is bright, with engine at stillstand, but it gets darker by starting the engine or it shines.</p> <ol style="list-style-type: none"> 1. Contact resistance in charging circuit or in the bulb wire. 2. Defective regulator. 3. Defective alternator. 	<ol style="list-style-type: none"> 1. Avoid such resistance. 2. Replace. 3. Have it repaired.
<p>The bulb light flickers.</p> <ol style="list-style-type: none"> 1. Wrong calibration in contact regulator resistance. 	<ol style="list-style-type: none"> 1. Replace the regulator.

REGULATOR

Brand Bosch AD1/14 V
(Bosch code: 0 190 601 013)

RECTIFIER

Brand Bosch 14 V 22 A
(Bosch code 0 197 002 003)

STARTER MOTOR

Brand Bosch DF (L) 12 V - 0,6 PS
Voltage 12 V
Output 0,6 HP
Current intensity 35 Amp.
Pinion Z = 8 mod. 2,5
Pinion rotation counterclockwise (as seen from the generator side)

ELECTRIC TEST

	VOLTAGE	CURRENT	SPEED	TORQUE
	V	A	rpm	Kpm
No load	11,5	20 ÷ 40	6500 ÷ 8500	—
Under load	9	170	3200 ÷ 3500	0,15
Short circuit	8	280 ÷ 360	—	0,75

IGNITION SYSTEM

MAINTENANCE, CHECKING AND ADJUSTMENT OF DOUBLE CONTACT BREAKER MAINTENANCE

Every 3000 km

Lightly moisten the cam felt «0» with some engine oil drops.

Checking (fig. 377)

— Remove the contact breaker cover by undoing the securing screws.

— If contacts «A» (right cylinder) and «B» (left cylinder) are dirty and greasy, clean them with a petrol moistened rag. Should the contacts in any way be damaged, replace them.

— Check points gap of contacts «A» (right cylinder - red cable) and «B» (left cylinder - green cable) which must be between $0,37 \div 0,43$.

Main features of double contact breaker

Points gap	$0,37 \div 0,43$ mm
Contact pressure	550 ± 50 gr
Opening angle	$180^\circ \pm 5^\circ$
Closing angle	$180^\circ \pm 5^\circ$
Breaker arm angle	$225^\circ \pm 1^\circ$
Automatic advance diagram	see fig. 161

Adjustment of contact points for right cylinder (red cable) (fig. 328)

Rotate the breaker shaft to bring the points to max. opening, then fit the blades of feeler gauge «A» partn. 12909090 between the points and check that the gap is as specified (mm $0,37 \div 0,43$).

In case of uncorrect gap, loosen screws «B» and «C» and turn the plate «D» to the left or to the right, acting on the notch «E» with a screw driver, so to obtain the correct gap.

Adjustment of contact points for left cylinder (green cable) (fig. 329)

Same as by the right cylinder ones except of: loosen the screws «B-C» and turn the plate «D» acting on the notch with a screw driver, so to obtain the correct gap.

IGNITION TIMING OF RIGHT CYLINDER (RED CABLE) (fig. 330)

— Connect the supplying clamp of the unit «A» to the red cable and the ground clamp «B» to one crankcase fin.

— Using a wrench «C» rotate the generator clockwise until, looking through the inspection hole, the letter «D» on the flywheel (right cyl-

inder) is aligned with the center mark of the inspection hole rim «E»; the piston must be at T.D.C. (closed valves).

— Rotate the generator counterclockwise until the mark on the flywheel «AF» (fixed advance) is aligned with the center mark of the inspection hole rim «E».

At this stage the indicator of the unit «F» starts moving clockwise.

If the indicator does not start moving at the specified point, loosen the screws securing double contact breaker to crankcase using the proper wrench 14 92 70 00 (13 fig.330) and turn the breaker to the left or to the right until the indicator of the unit «F» starts moving at the specified point.

The ignition timed, lock the screws securing the double contact breaker and detach the clamps.

IGNITION TIMING OF LEFT CYLINDER (GREEN CABLE) (fig. 331)

The right cylinder (red cable) timed, adjust the ignition timing of the left one (green cable).

Operations are the same as by the ignition timing for the right cylinder except of the following:

— connect the supplying clam «G» to the green cable ...

— using a wrench «C» rotate the generator clockwise until, looking through the inspection hole rim «E» ...

If the indicator of the unit «F» does not start moving at the specified point loosen the screws using screwdriver «H» and turn the plate to the right or to the left until the indicator starts moving at the specified point.

IGNITION DATA

Initial advance (static)	8°
Automatic advance	26°
Full advance	34°
Breaker contact points gap	mm $0,37 \div 0,43$

SPARK PLUGS

Recommended spark plug types:

- BOSCH 230 T 30
- CHAMPION N 9 Y

Points gap mm 0,5

To clean use: gasoline, wire brush, needle for inner cleaning.

In re-fitting the spark plugs, **ensure they are properly started by hand for a few turns**, completing the operation by means of the proper wrench in the tool kit. Should the spark plugs not be properly started, the threading on the cylinder head may get stripped.

For all events, the spark plugs have to be replaced every 10.000 km even if they appear to be in good condition.

ACOUSTIC SYSTEM

For this vehicle it includes:

- horn;
- ground, provided by the frame.

Features

Electric horn, high pitched tone, Manufacturer «Belli» (90/12/2).
Absorption 3 A.

LIGHTING SYSTEM

Headlight (fig. 379)

The headlight of this vehicle fits a two-filament bulb 40/45 W - 12 V for high and low beam and a 5 W - 12 V bulb for parking or town driving light.

Replacement of the headlight bulbs (fig. 379)

Undo the screw «B», down on the headlight insert, slip off the two bulb sockets and replace the bulbs.

Tail light (fig. 379)

The tail light fits a two-filament bulb 5/21 W - 12 V.

To remove this bulb loosen the screws «D» securing reflector to tail light, push the bulb inward turn and slip it off the socket.

In re-fitting the reflector onto the tail light do not lock the screws excessively not to break the reflector itself.

Turning Indicator lights

These fit a 21 W - 12 V bulb

To remove the bulbs loosen the screws securing the reflectors, push the bulbs inward turn and slip them off the socket.

In re-fitting the reflector do not lock the screws excessively not to break the reflector itself.

Instrument panel, km and rev. counters

These parts fit some bulbs which are replaced as follows:

Km and rev. counters

They fit a 3 W 12 V bulb, to replace slip it off the bulb socket.

Instrument panel

It fits five warning lights with 1,2 W - 12 V bulbs which can be replaced as follows.

Warning lights: «H - I - Oil - h - gen»: take the holder off the instrument panel and slip the bulb off the socket.

Warning light warning the fluid level in master cylinder for rear and left front brake; slip the bulb off the socket.

Bulb list

Headlight:

- high and low beam 40/45 W - 12 V
- park town driving 3 W - 12 V

Tail light:

- number plate lighting } 5/21 W - 12 V
- park stop light } 5/21 W - 12 V
- Turn indicator lights 4 bulbs 21 W - 12 V
- km and rev. counters 2 bulbs 3 W - 12 V
- Instrument panel 5 bulbs 1,2 W - 12 V

Headlight beam adjustment (fig. 379)

For a safe riding and not to trouble crossing riders, the headlight beam has always to be set at a correct height.

For horizontal setting act on screw «A».

For vertical setting undo the two screws «C» securing the headlight and shift it by hand upwards or down wards until to reach the correct height.

The center of the high beam must not be higher than m 0,86 measured at 3 m distance with motorcycle not on stand and rider on saddle.

Instrument panel (fig. 380)

- 1 km counter.
- 2 Rev. counter.
- 3 Orange neutral indicator. It lights when the gearbox is neutral position.
- 4 Green warning light indicating parking light on.
- Red warning light, oil pressure gauge. It goes out when the pressure is sufficient for normal engine lubrication. Should it not go out, this means that the oil pressure is not correct, in this case the engine has to be stopped and suitable checkings are to be carried out.
- 6 High beam warning light, blue.

— 7 Red warning light indicating insufficient current from the generator for battery charge. It must go out when the engine reaches a certain number of revolutions.

— 8 Red warning light indicating uncorrect brake fluid level in master cylinder for rear and left front brake. When this light is on, it is necessary to top up in master cylinder and inspect the braking circuit against fluid leakage.

Key switch (fig. 226)

The key has three positions.

- «0» vertical: Standstill, key removable.
- «1» turned counterclockwise: Standstill, button «A» (LIGHTS) in line with (PARK) lights on the parking light, key removable.
- «2» turned clockwise: Ready to start, all controls in, key not removable.

Lighting switch (LIGHTS) «A» (fig. 207)

On the L/H side of the handlebar, 4 position.

- «1» OFF Lights off.
- «2» PARK Parking light.
- «3» l Low beam.
- «4» h High beam.
- «5» Stop button. To bring the lever «Lights» to position «Off» turn button «5» towards the left.

Horn, flashing light and turn signals control («B» fig. 207)

On the L/H side of the handlebar.

- «6» HORN Horn button.

- «7» FLASH Flashing light button.
- «8» OFF Turn signals button.
Pos. «9» right signals on.
Pos. «10» left signals on.

Engine starting and emergency stopping («F» fig. 253/1)

On the R/H side of the handlebar. With the ignition key in position «2» fig. 226 the engine is ready to be started. To start the engine pull the clutch lever fully in and press the button «1» (START).

To stop the engine (in case of emergency) turn the lever to position «3» or «4» (OFF). The engine stopped, reset key to position «0» fig. 226.

Terminal block with fuses (fig. 231)

On the R/H side of the motorcycle. Access is made possible by taking off the right side cover. It holds n. 6 16 A fuses.

- «1» Rear and front stop light - Horn - Flashing light.
- «2» Starting relay - Turn signals.
- «3» Warning lights: Oil - Gen - N - Headlight: High and low beam together with warning lights.
- «4» Parking light, front and rear - Instrument lighting - Warning light «1».
- «5» - «6» Spare fuses.

CONTROLS

Clutch control lever (fig. 363)

On the L/H side of the handlebar, to be used for starting and gearshifting only.

Right front brake control lever («B» fig. 365)

On the R/H side of the handlebar, directly connected to the master cylinder controlling the right front brake.

Rear and Left Front brake control lever pedal («F» fig. 367)

On the R/H side of the motorcycle. Link connected to the master cylinder. It controls both rear and front left brake.

Gearshift control pedal (fig. 358/1)

On the L/H side of the motorcycle. Lever positions:

1st. gear	pedal down.
2nd. 3rd. 4th. 5th. gears	pedal up.
neutral	between 1st and 2nd gear.

Before operating the gearshift pedal, the clutch lever has to be fully pulled in.

Fuel filler cap for fuel tank (fig. 76)

To open it, press the control button «A».

Fuel taps (fig. 381)

Under the fuel tank, rear side. Positions:

«A» Open (vertical).
«R» Reserve (horizontal, see «R» on the taps).
«C» Closed (horizontal, see «C» on the taps).

It is advisable to keep open the left tap only, the right tap is to be opened when the left one does not give any more fuel.

Steering damper control (fig. 226)

On the steering column, controlled from the top of the column itself.

— Position «A»: damper at rest.
— Position «B»: damper at work.

Starter control (fig. 357)

The control lever for starting a cold engine (Starter) is screwed to the rocker box cover of the left cylinder.

«A» Starting position.
«B» Riding position.

Steering damper

It is screwed to its control plate and welded to the frame.

For its control see paragraph **Steering damper control** and fig. 226.

Throttle control twist grip (fig. 358)

On the R/H side of the handlebar; the throttle is opened by turning the grip towards the rider and closed viceversa.

Steering locking («A» fig. 232)

To lock:

— Turn the handlebar fully to the right.
— Insert the key into the lock set, turn it counterclockwise and push fully in, release and take off.

To release:

— Insert the key into the lock set, turn it counterclockwise then release and take off.

Side Stand

The side stand is of automatic return type and recommended for short parking only. For longer staying use the central stand.

LUBRICATION AND MAINTENANCE CHART

Monthly (or every 3.000 km)

- 1 Check the electrolyte level in the battery. (see chapter Electrical Equipment - «Battery»).

Periodically

- 2 Check tyre pressure (see chapter «Removal of wheels «Tyres»).

Every 500 km

- 3 Check oil level in the crankcase (see chapter «Lubrication»).

After the first 500 ÷ 1.000 km

- 4 Replace the crankcase oil (see chapter Lubrication).
- 5 Check and eventually tighten all nuts and bolts.
- 6 Check rocker clearance (see chapter «Valve gearing» «Rocker clearance»).

Every 3.000 km

- 7 Replace the crankcase oil (see chapter Lubrication).
- 8 Check rocker clearance (see chapter Valve gearing - Rocker Clearance).
- 9 Check the oil level in the gearbox (see chapter Lubrication).
- 10 Check the oil level in the rear drive box (see chapter Lubrication).

Every 5.000 km

- 11 Check the fluid level in the fluid reservoir

for front brake, ensure it has not fell down under the transparent reservoir.

The fluid level for rear and left front brake is warned by the proper light (red) on the instrument panel. (see chapter Maintenance and Adjustments «Checking the fluid level and replacing the brake fluid in reservoirs.

Every 10.000 km

- 12 Clean the fuel tank, the fuel taps, the filters and the fuel lines see Chapter Maintenance «Cleaning the fuel tank, filters, taps and fuel lines».

- 13 Replace the oil in the gear box (see chapter lubrication).

- 14 Replace the oil in the rear drive box (see chapter Lubrication).

- 15 Clean and smear all battery connection (see chapter Electrical Equipment).

Every 15.000 km

Replace the fluid in brake fluid reservoirs (see chapter «Maintenance and Adjustments». Checking the fluid level and replacing the fluid in fluid reservoirs).

After the first 20.000 km

All checkings hereunder described must be carried out by our dealers:

- 17 Check there is sufficient grease in the wheel bearings.

- 18 Check there is sufficient grease in the steering bearings «Agip F. 1 Grease 30».

- 19 Replace the oil in the fork covers (see chapter Lubrication).

- 20 Clean starter motor and generator commutator using a clean rag slightly moistened with petrol.

ELECTRIC WIRING DIAGRAM

(fig. 382)

- 1 Km counter, bulb 3 W.
- 2 Rev. counter, bulb 3 W.
- 3 High beam warning light, bulb 1,2 W.
- 4 Oil pressure warning light, bulb 1,2 W.
- 5 Neutral warning light, bulb 1,2 W.
- 6 Parking light warning, bulb 1,2 W.
- 7 Generator charge warning light, bulb 1,2 W.
- 8 High beam } bulb 40/45 W.
- 9 Low beam }
- 10 Right front turn signal, bulb 21 W.
- 11 Left front turn signal, bulb 21 W.
- 12 Engine starting and stopping switch.
- 13 Lighting switch.
- 14 Switch: turn signals, starting, horn, flashing light.
- 15 Horn (Absorption 3,5 A).
- 16 Front brake stop light cutout.
- 17 Flashing light relay.
- 18 Rear brake stop light cutout.
- 19 Battery 12 V - 20 Ah.
- 20 Regulator.
- 21 Rectifier.
- 22 Alternator (14 V 20 A).
- 23 Starter motor relay.
- 24 Starter motor (12 V - 0,7 HP).
- 25 Left rear turn signal, bulb 21 W.
- 26 Rear brake stop light } bulb 5/21 W
- 27 Number plate and parking light }
- 28 Right rear turn signal, bulb 21 W.
- 29 Flasher unit.
- 30 Oil pressure cutout.
- 31 Neutral position cutout.
- 32 Terminal block with fuses (16 A fuses).
- 33 Contact breaker.
- 34 Coils.
- 35 Ignition switch (3 positions).
- 36 Spark plugs.
- 37 Parking light front, bulb 3 W.
- 38 Brake fluid level warning light (Brake) bulb 1,2 W.
- 39 Brake fluid level indicator cutout left and rear braking circuit.

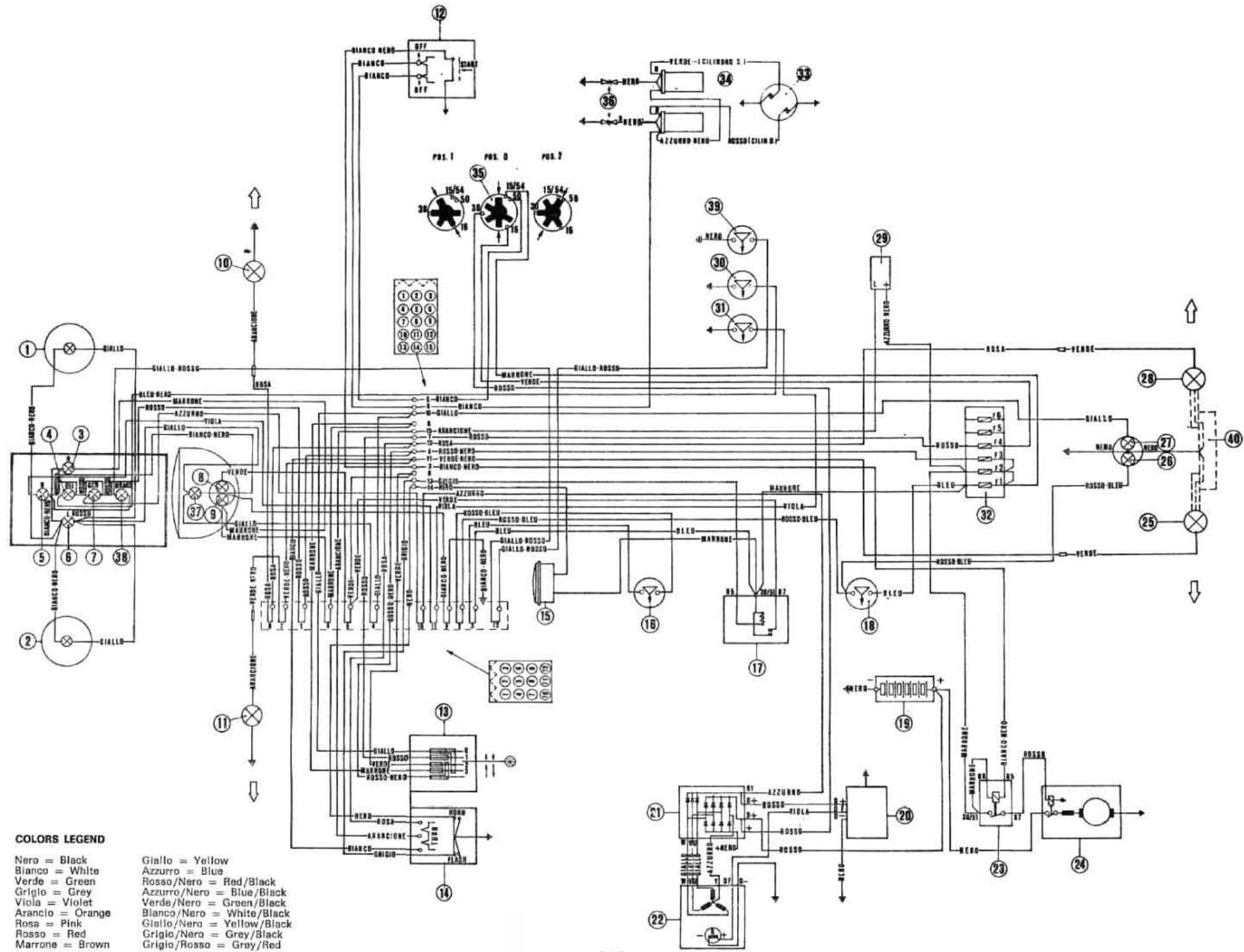

382

ELECTRIC WIRING DIAGRAM

(fig. 382)

- 1 Km counter, bulb 3 W.
- 2 Rev. counter, bulb 3 W.
- 3 High beam warning light, bulb 1,2 W.
- 4 Oil pressure warning light, bulb 1,2 W.
- 5 Neutral warning light, bulb 1,2 W.
- 6 Parking light warning, bulb 1,2 W.
- 7 Generator charge warning light, bulb 1,2 W.
- 8 High beam } bulb 40/45 W.
- 9 Low beam }
- 10 Right front turn signal, bulb 21 W.
- 11 Left front turn signal, bulb 21 W.
- 12 Engine starting and stopping switch.
- 13 Lighting switch.
- 14 Switch: turn signals, starting, horn, flashing light.
- 15 Horn (Absorption 3,5 A).
- 16 Front brake stop light cutout.
- 17 Flashing light relay.
- 18 Rear brake stop light cutout.
- 19 Battery 12 V - 20 Ah.
- 20 Regulator.
- 21 Rectifier.
- 22 Alternator (14 V 20 A).
- 23 Starter motor relay.
- 24 Starter motor (12 V - 0,7 HP).
- 25 Left rear turn signal, bulb 21 W.
- 26 Rear brake stop light } bulb 5/21 W
- 27 Number plate and parking light }
- 28 Right rear turn signal, bulb 21 W.
- 29 Flasher unit.
- 30 Oil pressure cutout.
- 31 Neutral position cutout.
- 32 Terminal block with fuses (16 A fuses).
- 33 Contact breaker.
- 34 Coils.
- 35 Ignition switch (3 positions).
- 36 Spark plugs.
- 37 Parking light front, bulb 3 W.
- 38 Brake fluid level warning light (Brake) bulb 1,2 W.
- 39 Brake fluid level indicator cutout left and rear braking circuit.

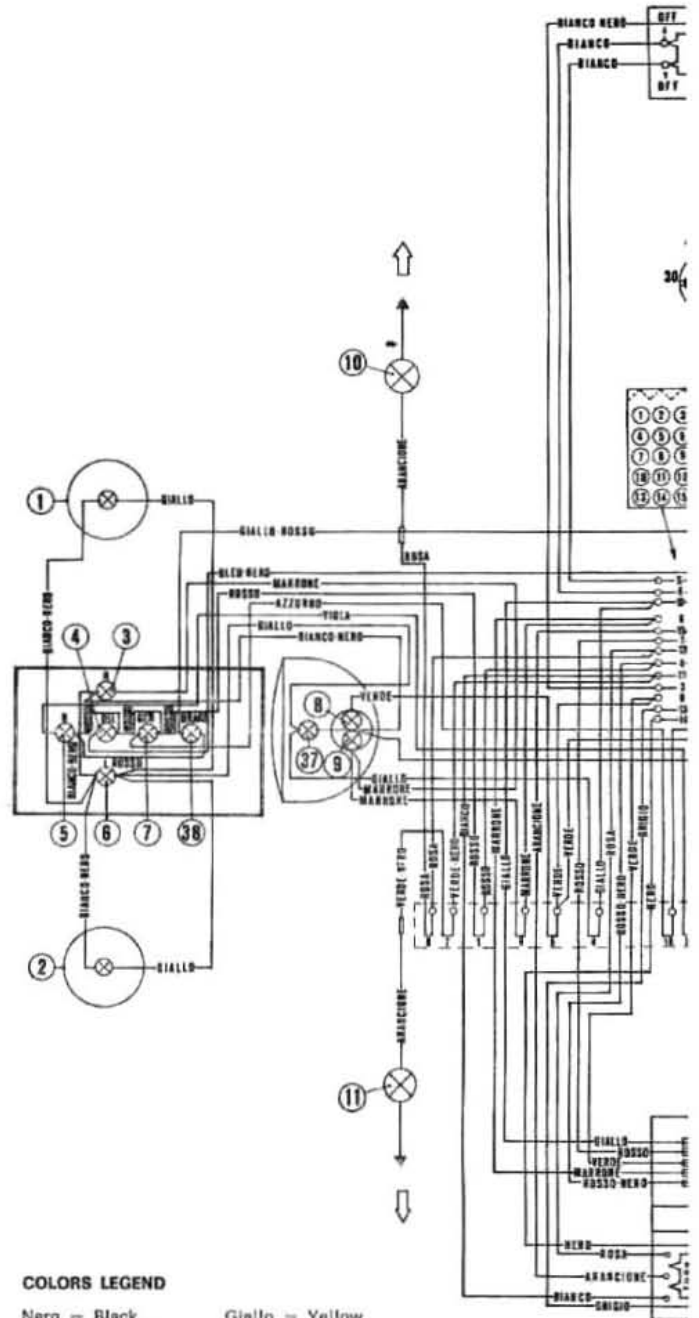

COLORS LEGEND

Nero = Black	Giallo = Yellow
Bianco = White	Azzurro = Blue
Verde = Green	Rosso/Nero = Red/Black
Grigio = Grey	Azzurro/Nero = Blue/Black
Viola = Violet	Verde/Nero = Green/Black
Arancio = Orange	Bianco/Nero = White/Black
Rosa = Pink	Giallo/Nero = Yellow/Black
Rosso = Red	Grigio/Nero = Grey/Black
Marrone = Brown	Grigio/Rosso = Grey/Red

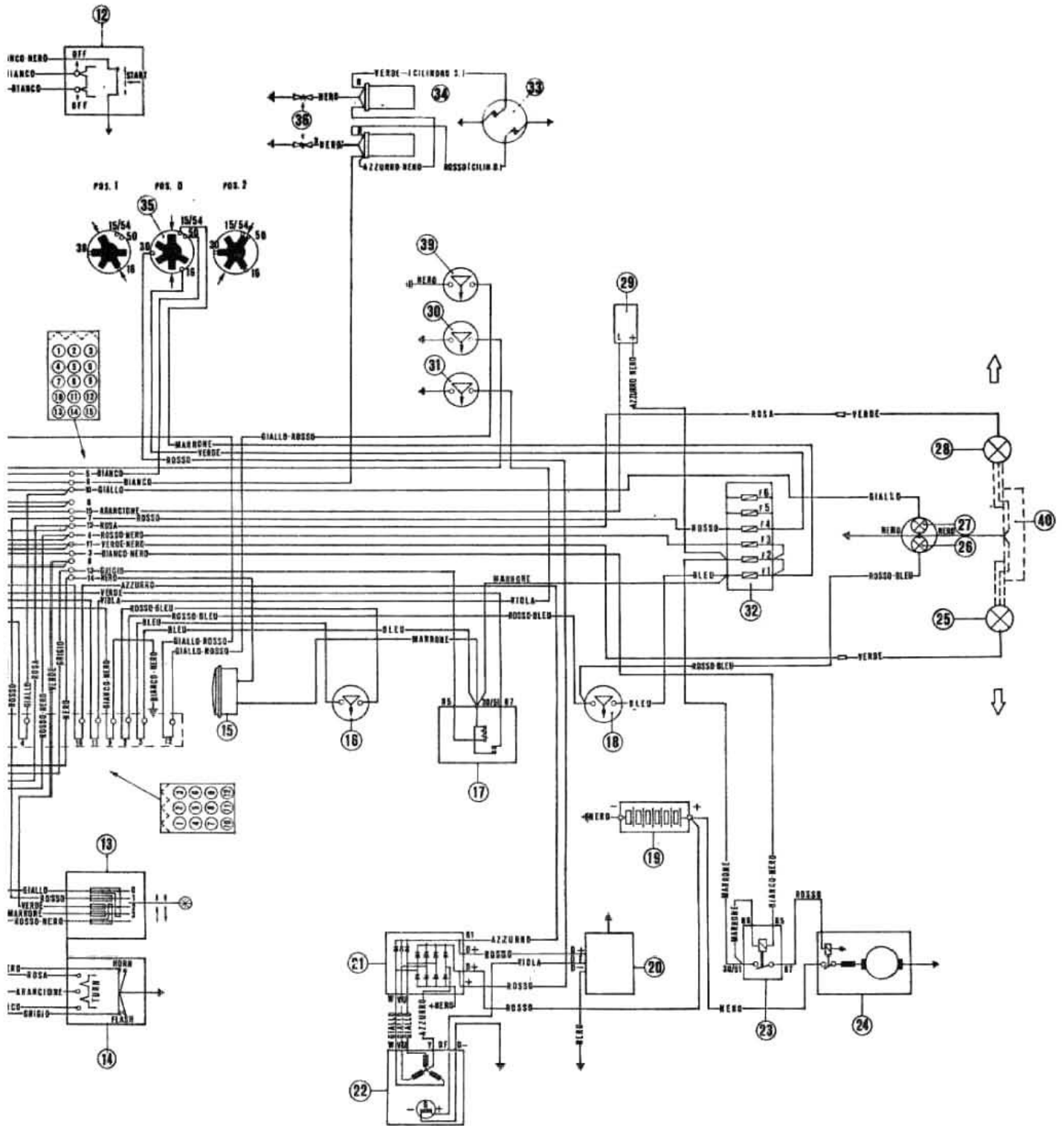

KITS AVAILABLE ON REQUEST

New gearbox kit fitting a straight toothed gear set allowing to get various gearbox ratios.
Such a kit, under partn. **14 21 00 41** includes the parts listed hereunder (see fig. 383).

FIG. N.	PARTN.	DESCRIPTION	Q.TY
1	14 21 05 40	Main shaft (Z = 24-22-20-17)	1
1	14 21 05 41	Main shaft (Z = 24-22-19C-16C)	1
2	14 21 20 40	5th speed gear on mainshaft (Z = 25)	1
3	14 21 11 40	Transmission gear (Z = 16)	1
3	14 21 11 41	Transmission gear (Z = 17)	1
4	14 21 52 40	5th speed gear on layshaft (Z = 17)	1
5	14 21 51 40	4th speed gear on layshaft (Z = 20)	1
6	14 21 48 40	3rd speed gear on layshaft (Z = 22)	1
7	14 21 45 40	2nd speed gear on layshaft (Z = 22)	1
7	14 21 45 41	2nd speed gear on layshaft (Z = 24C)	1
8	14 21 42 40	1st speed gear on layshaft (Z = 26)	1
8	14 21 42 41	1st speed gear on layshaft (Z = 26C)	1

Ps: It is pointed out that such a modification will result in the model «850 Le Mans» being off: WARRANTY, TYPE APPROVAL (D.G.M.) and VEHICLE CODE. AS a consequence these motorcycles will be able for going closed courses only.

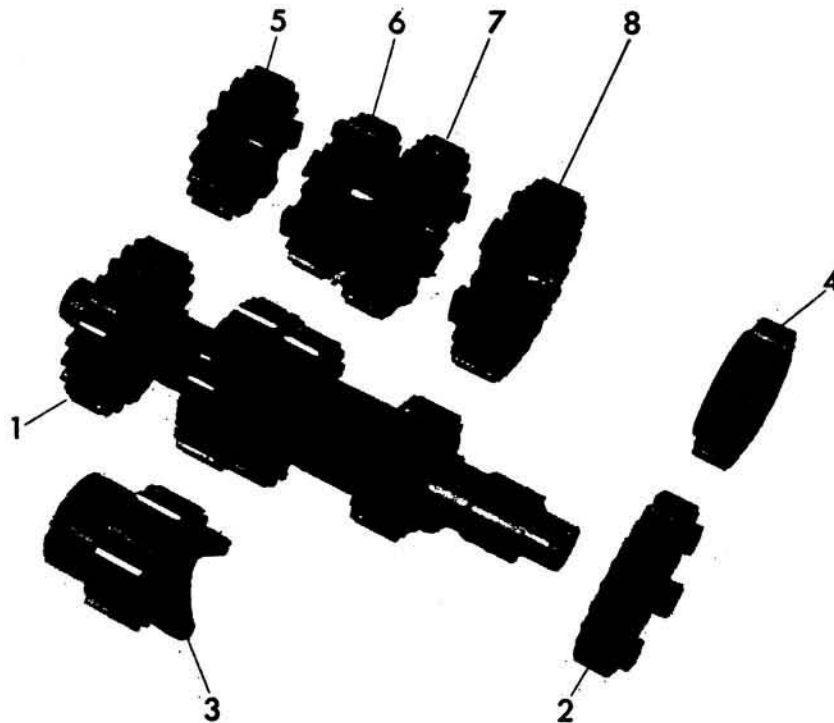

383

NOTICE:

1 The gears which are outlined by a mark «C» near the teeth number will have to be mounted in matching condition.

These parts can be recognized by means of:

— A round mark of turning on the tothing middle, for single 1st and 2nd speed gears on layshaft.

— A double mark of turning on the middle coupling part, for double 1st and 2nd speed gears on mainshaft.

2 To mount the parts of this kit, a certain number of manufactured vehicles require also the fitting of the «Cush drive sleeve» partn. 14 21 12 01 wich is identifiable through the \varnothing indicated in the drawing (see fig. 384).

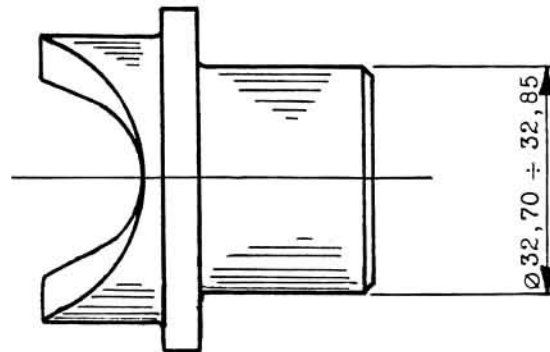

384

3 This kit under partn. 14 21 00 41 cancels and replaces the kit under partn. 14 21 01 40. (Refer to the technical bulletin of Spare Parts, n. 5 August 1974).

New bevel gear sets:

1 6/32 - ratio 5,333 - partn. 17 35 46 90 - to be mounted with double cardan joint 14 32 80 40 and sleeve 18 32 77 00.

2 7/55 - ratio 4,714 - partn. 17 35 46 50 - to be mounted with double cardan joint 17 32 60 50 and sleeve 12 32 77 00.

3 8/33 - ratio 4,125 - partn. 14 35 46 40 - to be mounted with double cardan joint 14 32 80 40 and sleeve 18 32 77 00.

4 9/34 - ratio 3,778 - partn. 18 35 46 50 - to be mounted with double cardan joint 14 32 80 40 and sleeve 18 32 77 00.

GEARBOX TYPE «A» (see fig. 385)

Transmission gear of clutch shaft: Z/17 or Z/16.

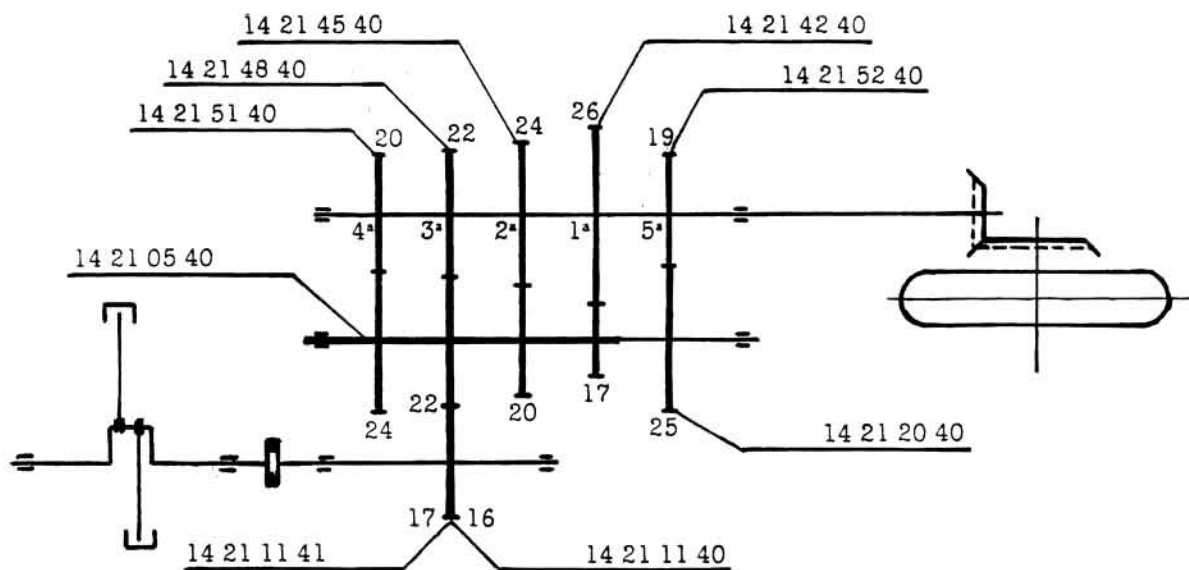

385

OVERALL GEAR RATIOS

With transmission gear of clutch shaft Z/17 partn. 14 21 11 41.

BEVEL GEAR SET	1st.	2nd.	3rd.	4th.	5th.
6/32 = 5,333	10,554	8,282	6,901	5,749	5,242
7/33 = 4,714	9,329	7,321	6,10	5,03	4,634
8/33 = 4,125	8,163	6,406	5,338	4,447	4,055
9/34 = 3,778	7,477	5,867	4,889	4,073	3,714
THEORETICAL SPEED BY 7.500 R.P.M. (rear tyre developent mm 2.020)					
BEVEL GEAR SET	1st.	2nd.	3rd.	4th.	5th.
6/32	85,27	108,66	130,41	156,54	171,69
7/33	96,47	122,93	147,54	177,16	194,21
8/33	110,25	140,49	168,60	202,38	221,94
9/34	120,36	153,40	184,08	220,96	242,32

OVERALL GEAR RATIOS

With transmission gear of clutch shaft Z/16 partn. 14 21 11 40

BEVEL GEAR SET	1st.	2nd.	3rd.	4th.	5th.
6/32 = 5,333	11,210	8,799	7,333	6,106	5,573
7/33 = 4,714	9,909	7,778	6,482	5,398	4,926
8/33 = 4,125	8,671	6,806	5,672	4,725	4,311
9/34 = 3,778	7,941	6,234	5,195	4,326	3,948
THEORETICAL SPEED BY 7.500 R.P.M. (rear tyre development mm 2.020)					
BEVEL GEAR SET	1st.	2nd.	3rd.	4th.	5th.
6/32	80,28	102,28	122,73	147,39	161,49
7/33	90,82	115,71	138,84	166,72	182,70
8/33	103,79	132,23	158,67	190,47	208,76
9/34	113,33	144,36	173,24	208,04	227,96

GEARBOX TYPE «B» - 1st and 2nd low (see fig. 386)

Transmission gear of clutch shaft: Z/17 or Z/16.

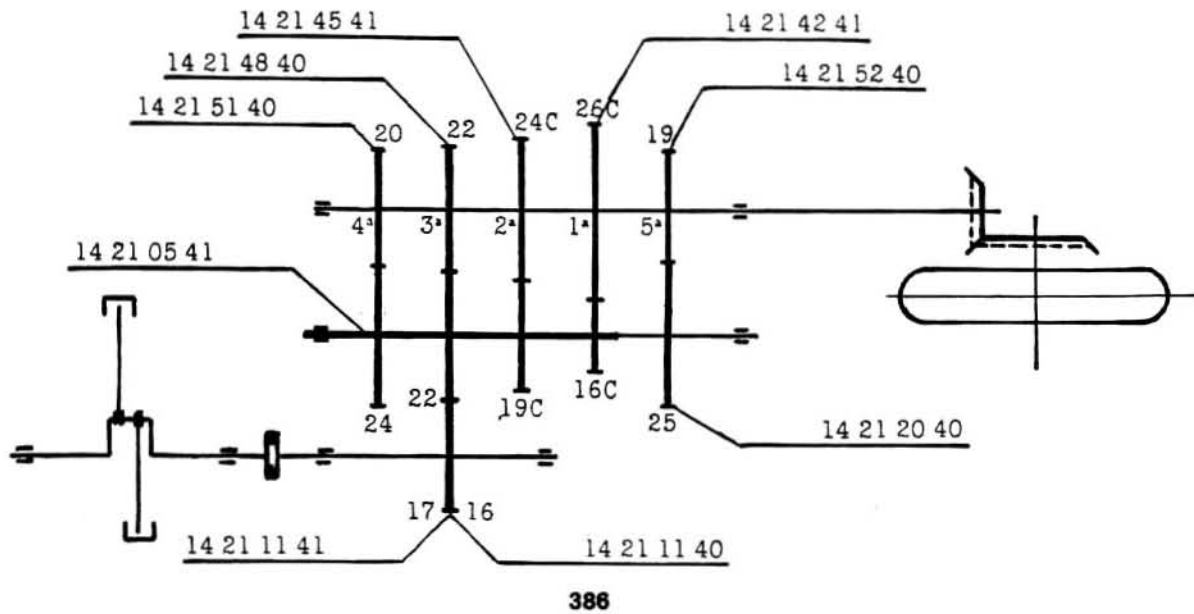

OVERALL GEAR RATIOS

With transmission gear of the clutch shaft Z/17 aprtn. 14 21 11 41

BEVEL GEAR SET	1st.	2nd.	3rd.	4th.	5th.
6/32 = 5,333	11,215	8,714	6,901	5,749	5,242
7/33 = 4,714	9,914	7,703	6,10	5,08	4,634
8/33 = 4,125	8,675	6,740	5,338	4,447	4,055
9/34 = 3,778	7,945	6,177	4,889	4,073	3,714
THEORETICAL SPEED BY 7.500 R.P.M. (rear tyre development mm 2.020)					
BEVEL GEAR SET	1st.	2nd.	3rd.	4th.	5th.
6/32	80,24	103,28	130,41	156,54	171,69
7/33	90,78	116,83	147,54	177,16	194,21
8/33	103,74	133,53	168,60	202,38	221,94
9/34	113,27	145,70	184,08	220,96	242,32

OVERALL GEAR RATIOS

With transmission gear of clutch shaft Z/16 partn. 14 21 11 40.

BEVEL GEAR SET	1st.	2nd.	3rd.	4th.	5th.
6/32 = 5,333	11,914	9,263	7,333	6,106	5,573
7/33 = 4,714	10,531	8,188	6,482	5,398	4,926
8/33 = 4,125	9,215	7,165	5,672	4,725	4,311
9/34 = 3,778	8,440	6,562	5,195	4,326	3,948
THEORETICAL SPEED BY 7.500 R.P.M. (rear tyre development mm 2.020)					
BEVEL GEAR SET	1st.	2nd.	3rd.	4th.	5th.
6/32	75,54	97,16	122,73	147,39	161,49
7/33	85,46	109,91	138,84	166,72	182,70
8/33	97,66	125,61	158,67	190,47	208,76
9/34	106,63	137,15	173,24	208,04	227,96

ENGINE POWERING KIT

A special kit is now available to power the engine of the 850 LE MANS on racing purpose. Such a kit, under partn. 14 99 97 40, includes the components listed hereover. To complete this powering it is necessary to bore and polish the inlet and outlet tubes and to shim the valve springs according to the drawing hereover (see fig. 387).

PARTN.	Q.TY	DESCRIPTION
14 15 33 40	1	Cam shaft
14 02 08 40	2	Gasket
14 11 26 40	1	Right carburettor
14 11 26 41	1	Left carburettor
14 11 50 40	1	Right manifold
14 11 50 41	1	Left manifold
14 12 07 41	1	Exhaust pipes
14 12 30 41	1	Right silencer
14 12 29 41	1	Left silencer
14 12 39 41	1	Silencer connecting tube

PS: It is pointed out that such a modification will result in the model «850 Le Mans» being off: WARRANTY, TYPE APPROVAL (D.G.M.) and VEHICLE CODE. As a consequence these motorcycles will be able for going closed courses only.

Inlet

Set 1 to 7 washers
partn 14 03 73 00 between the
part 13 03 72 00 and the
cylinder head

Outlet

Set 0 to 6 washers
partn. 14 03 73 00 between the
part 13 03 72 00 and the
cylinder head

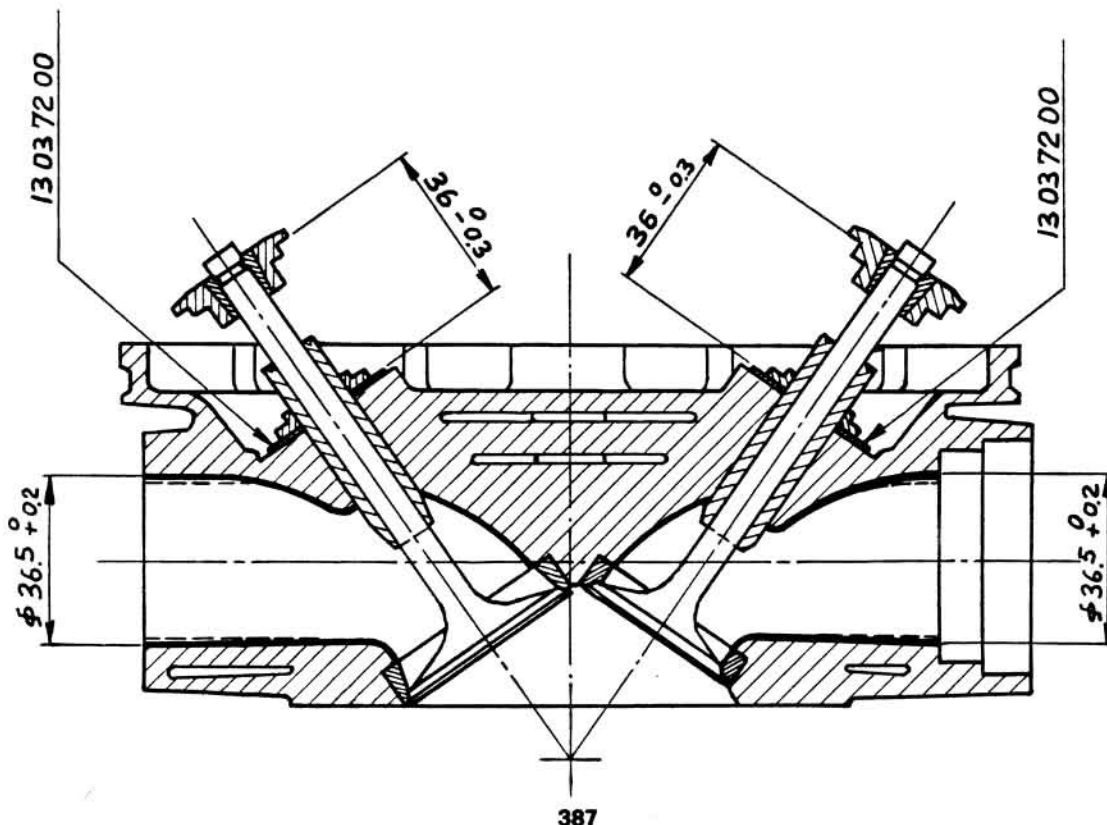

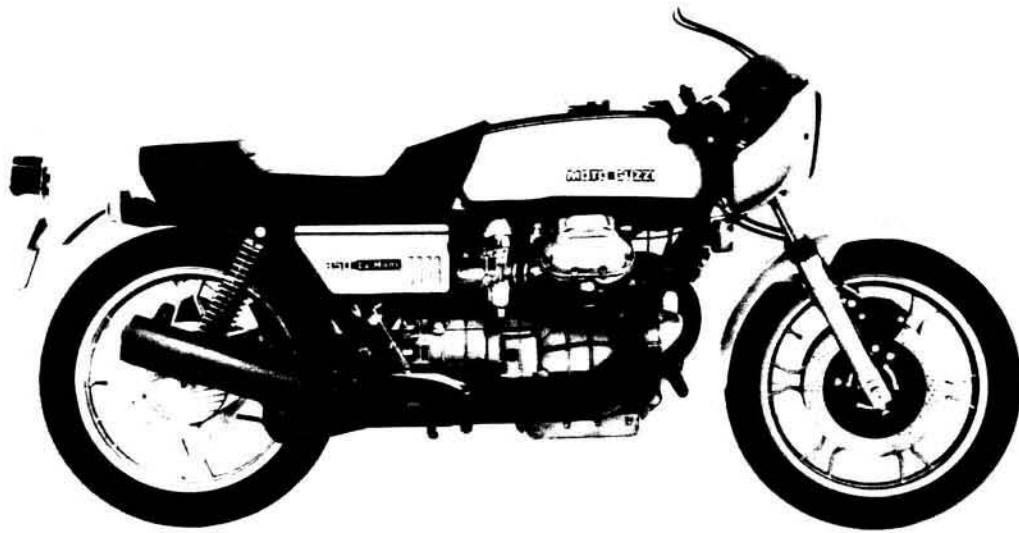

347

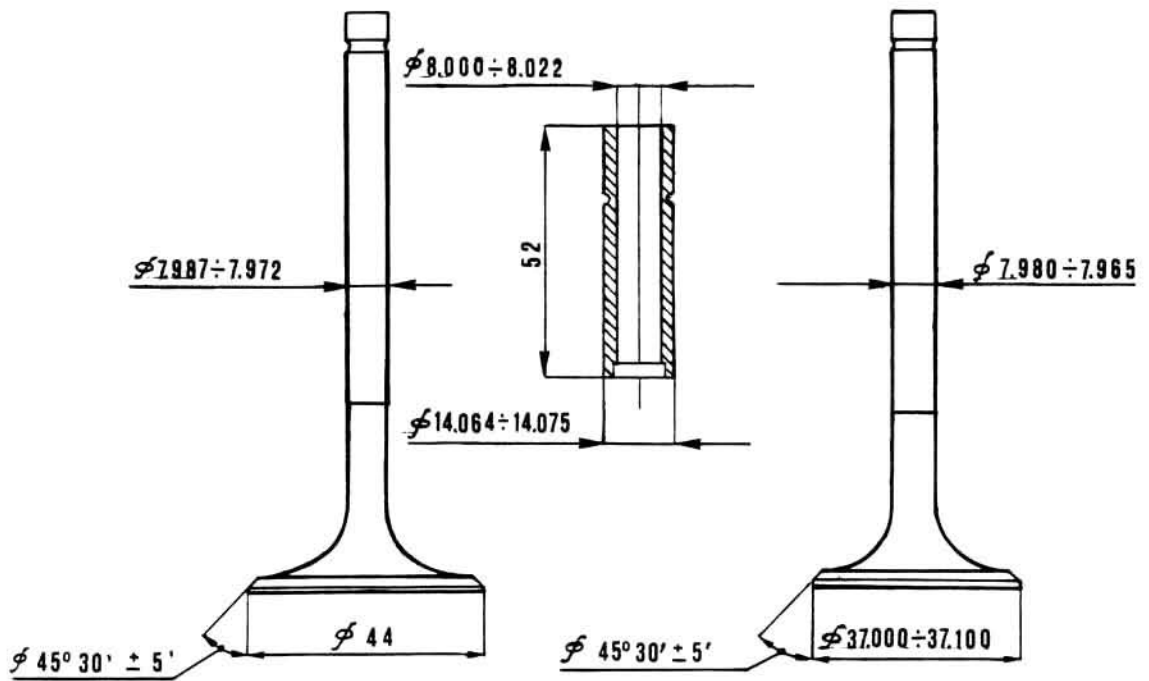

348

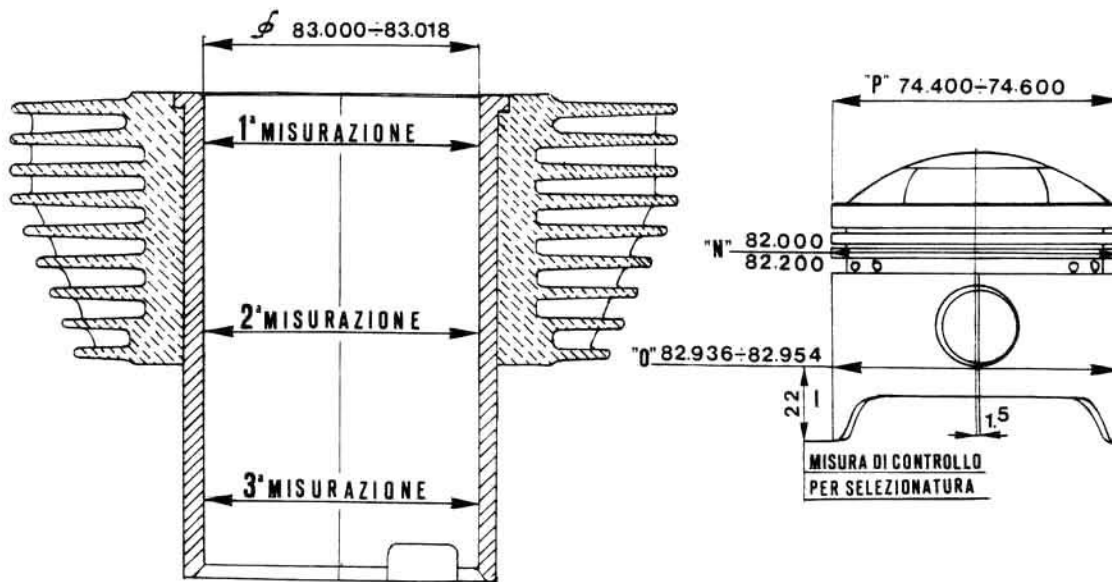

349

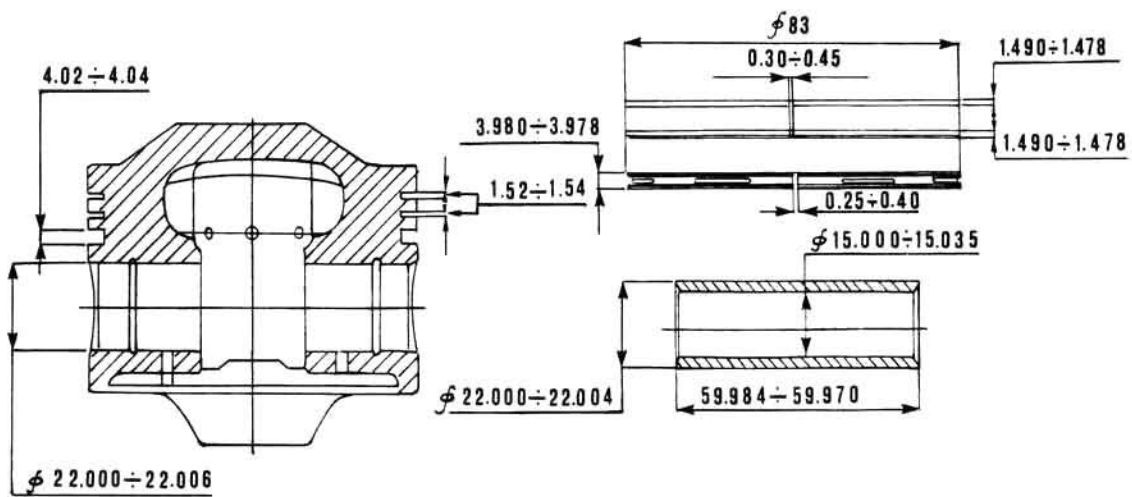

350

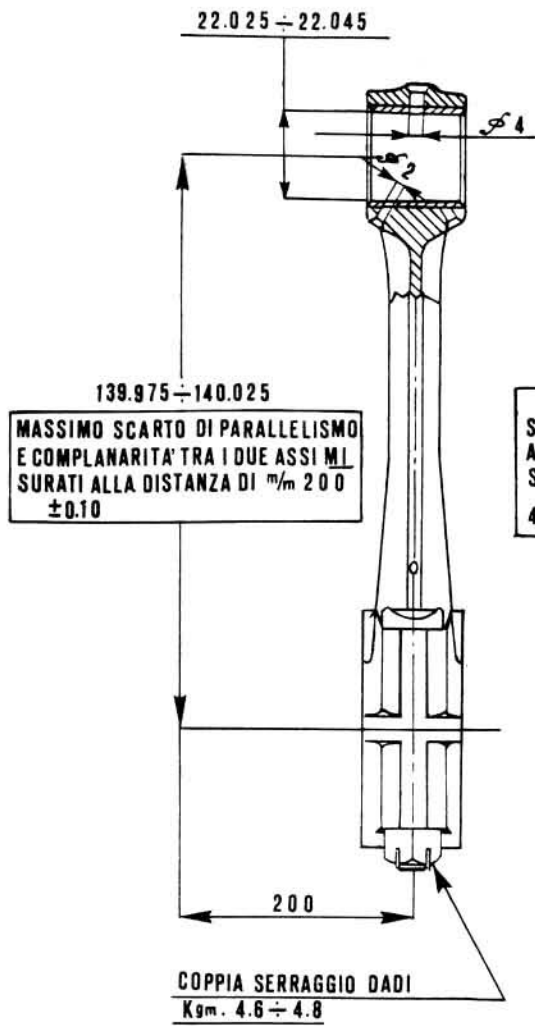

351

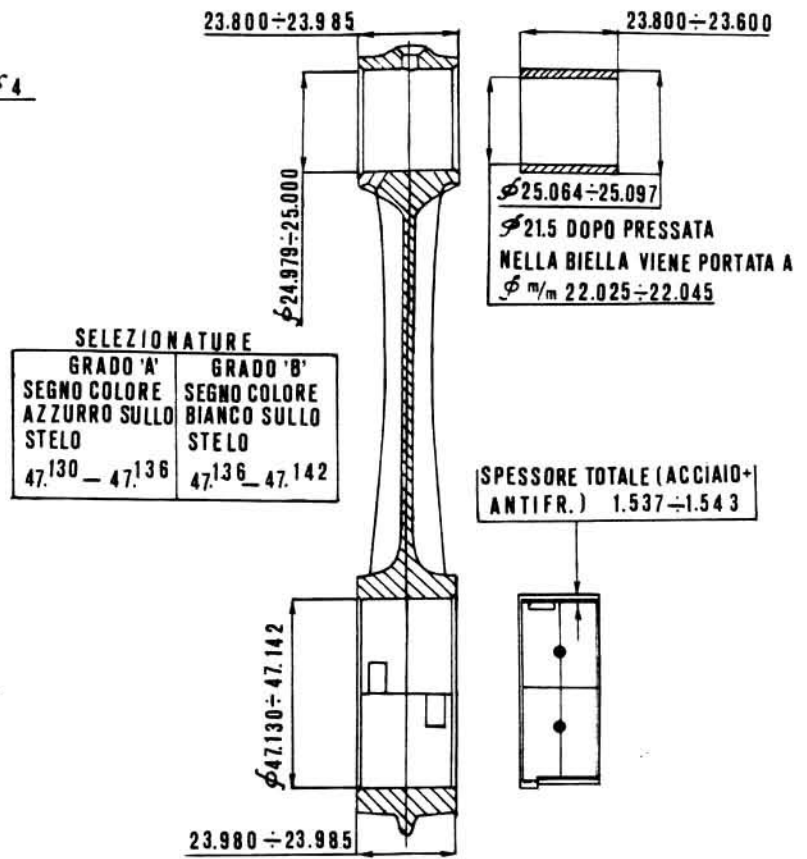

352

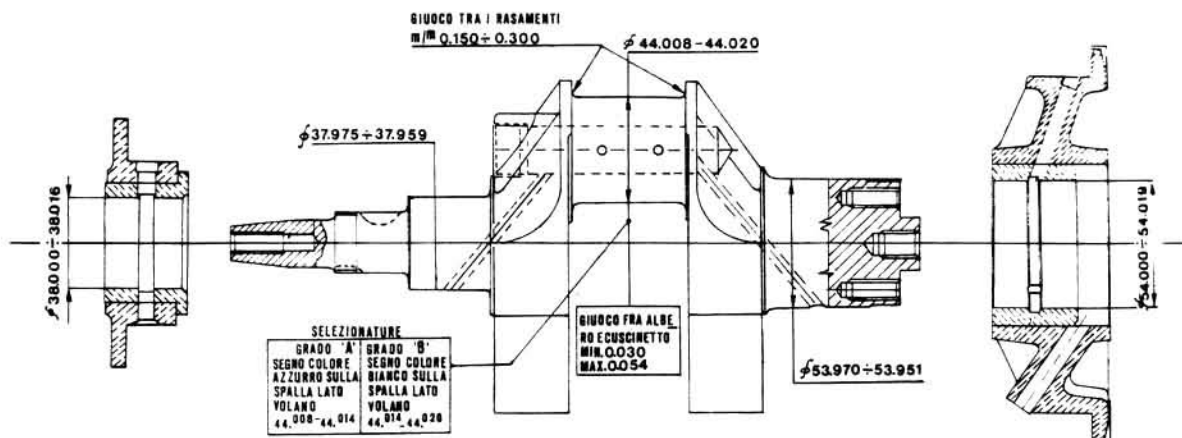

353

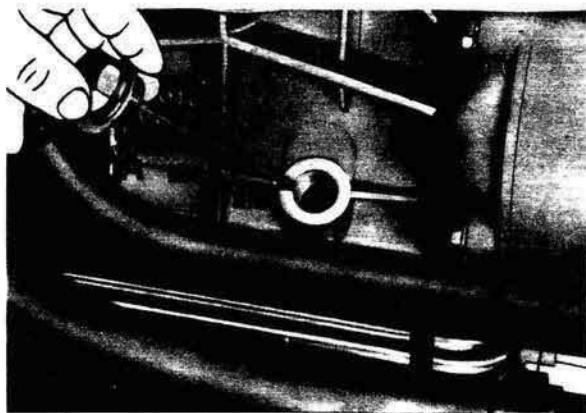

354

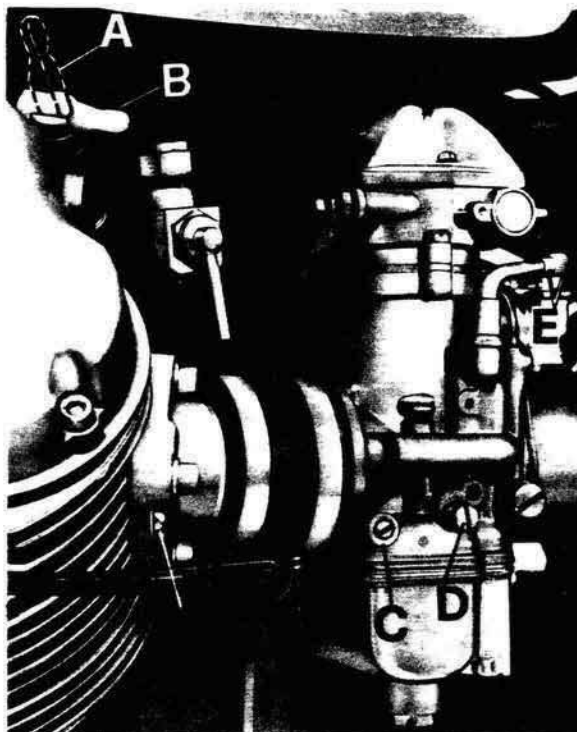

357



355

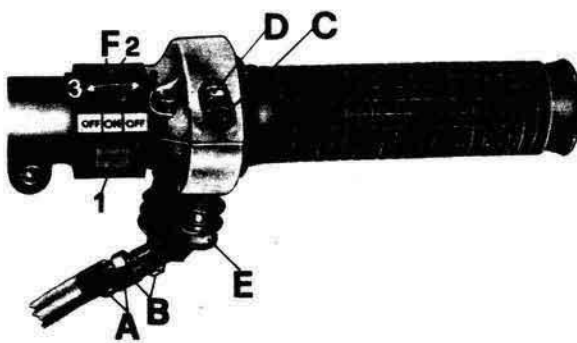

358



356

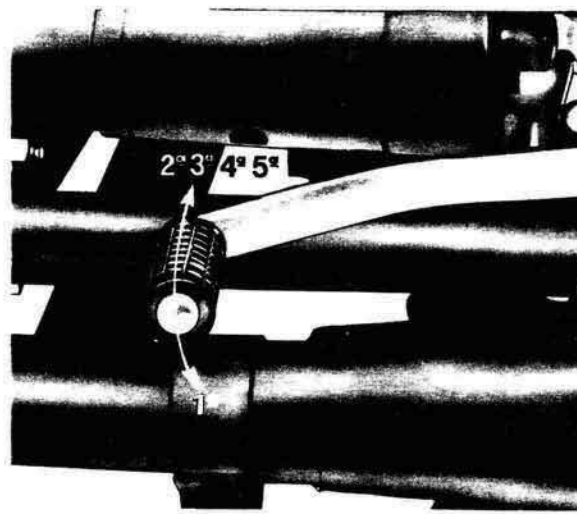

358/1

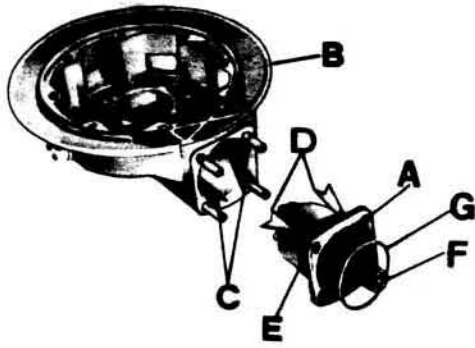

358/2

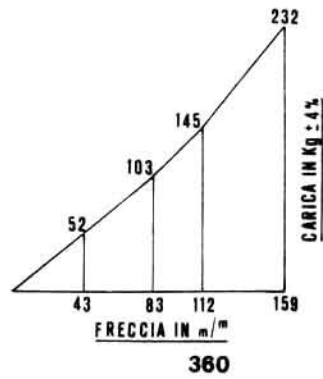
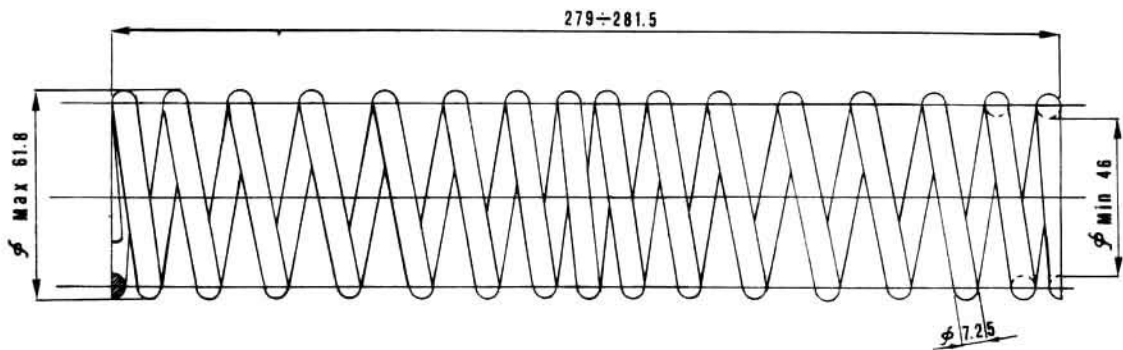
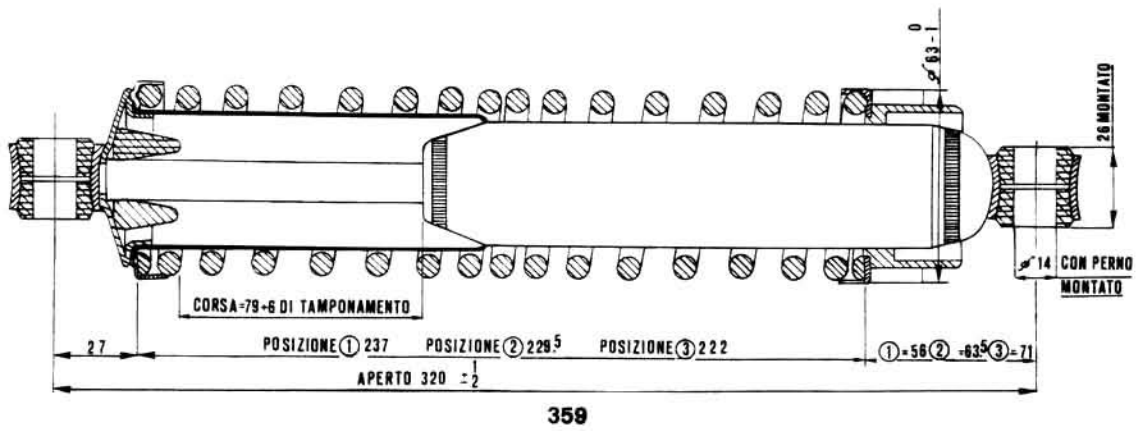

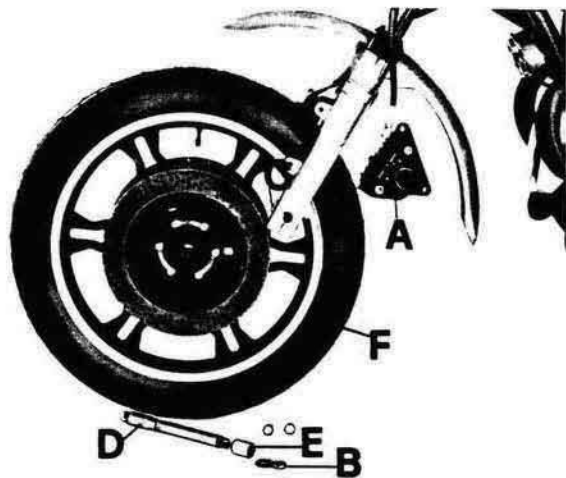

361

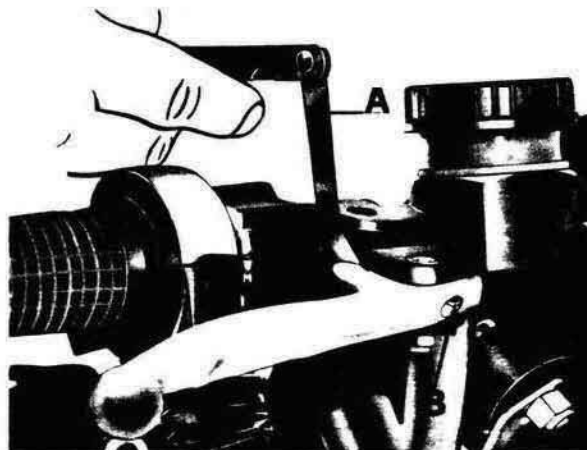

364

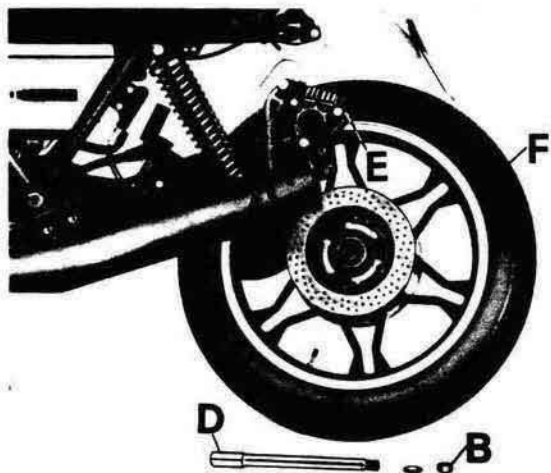

362

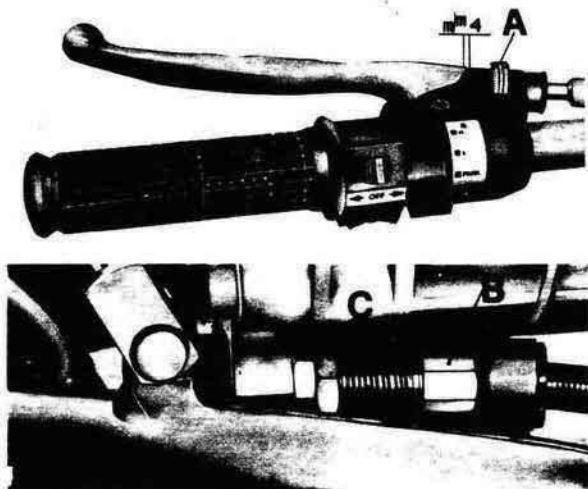
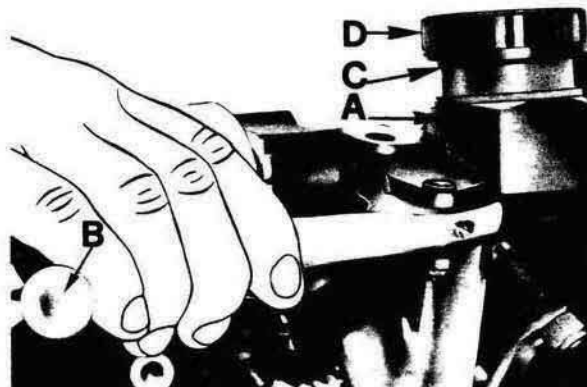

363



365

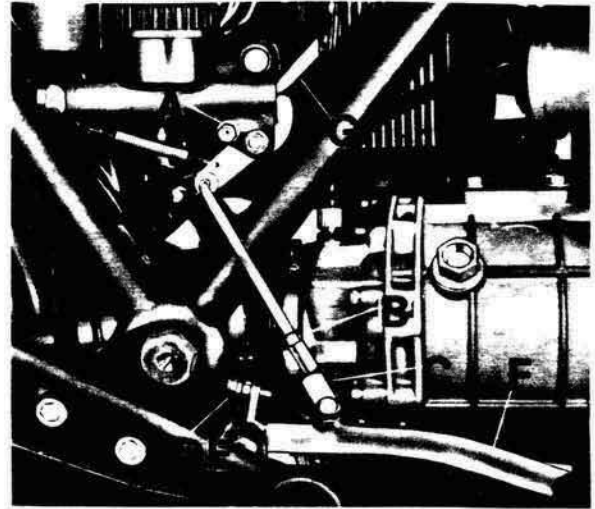
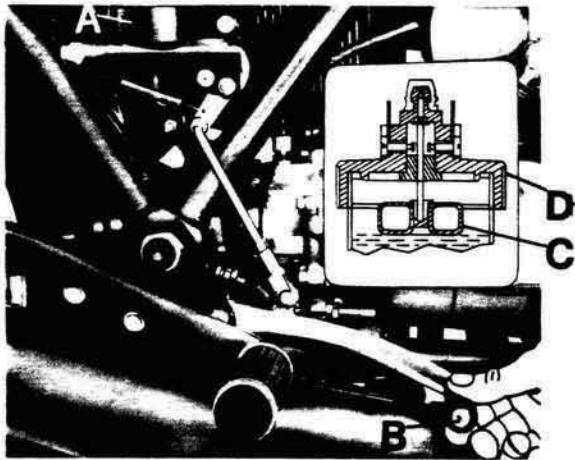

367

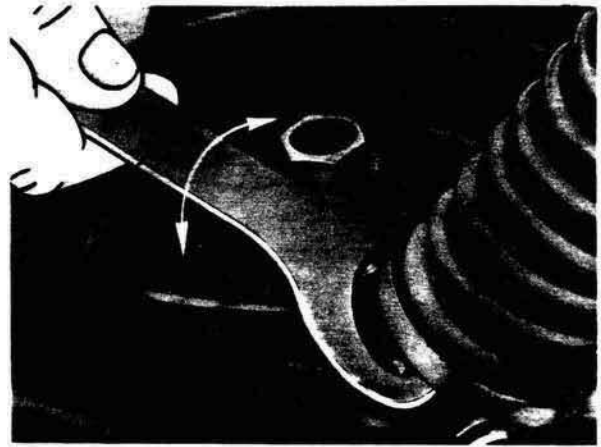
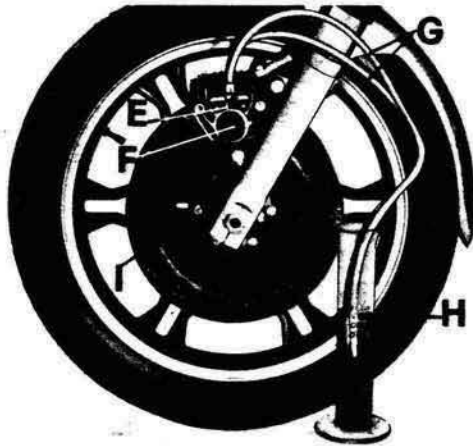

368

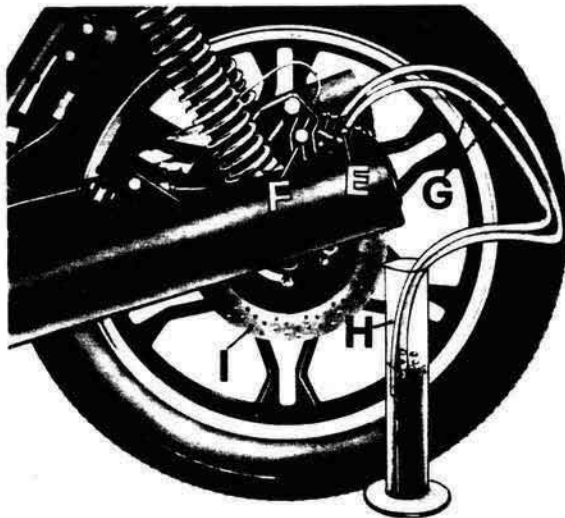

366



369

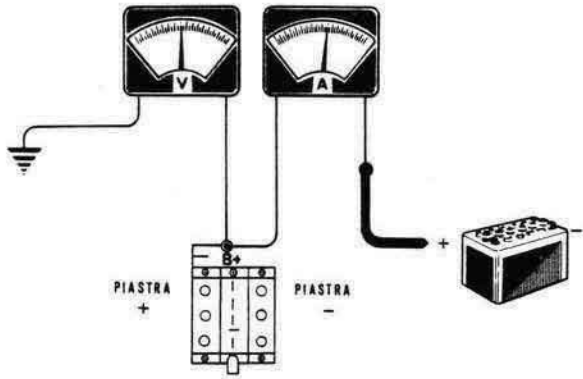

370

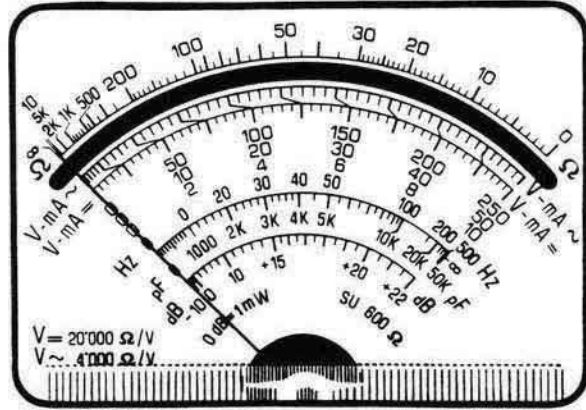

373

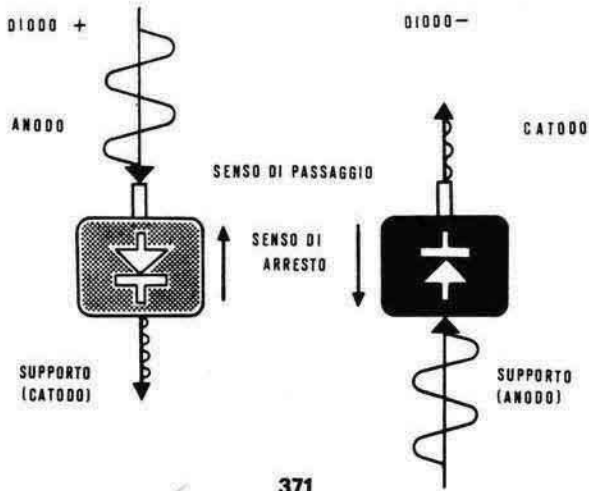

371

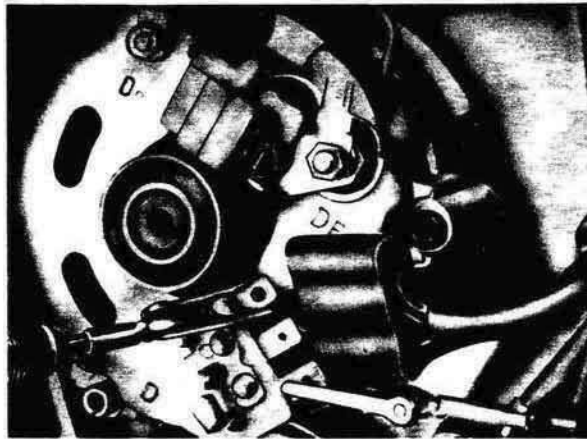

374

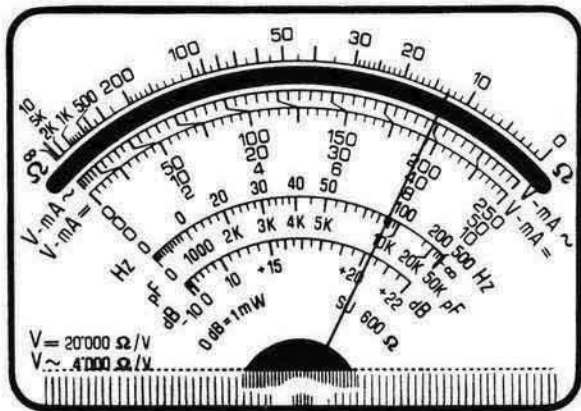

372



375

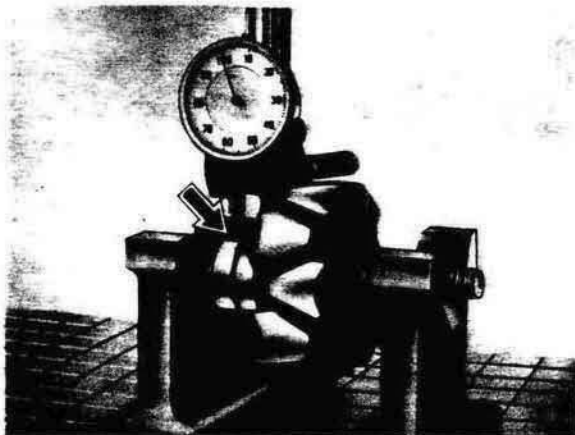

376

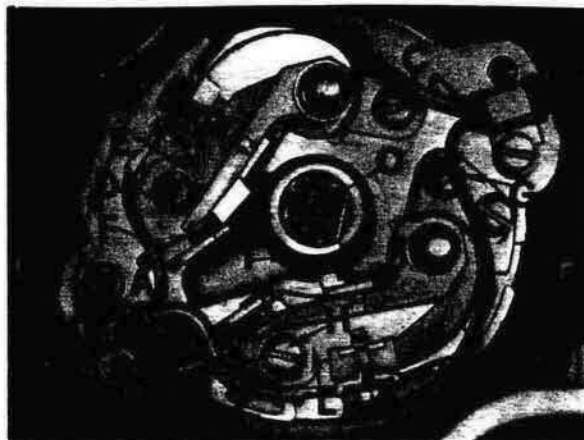

377

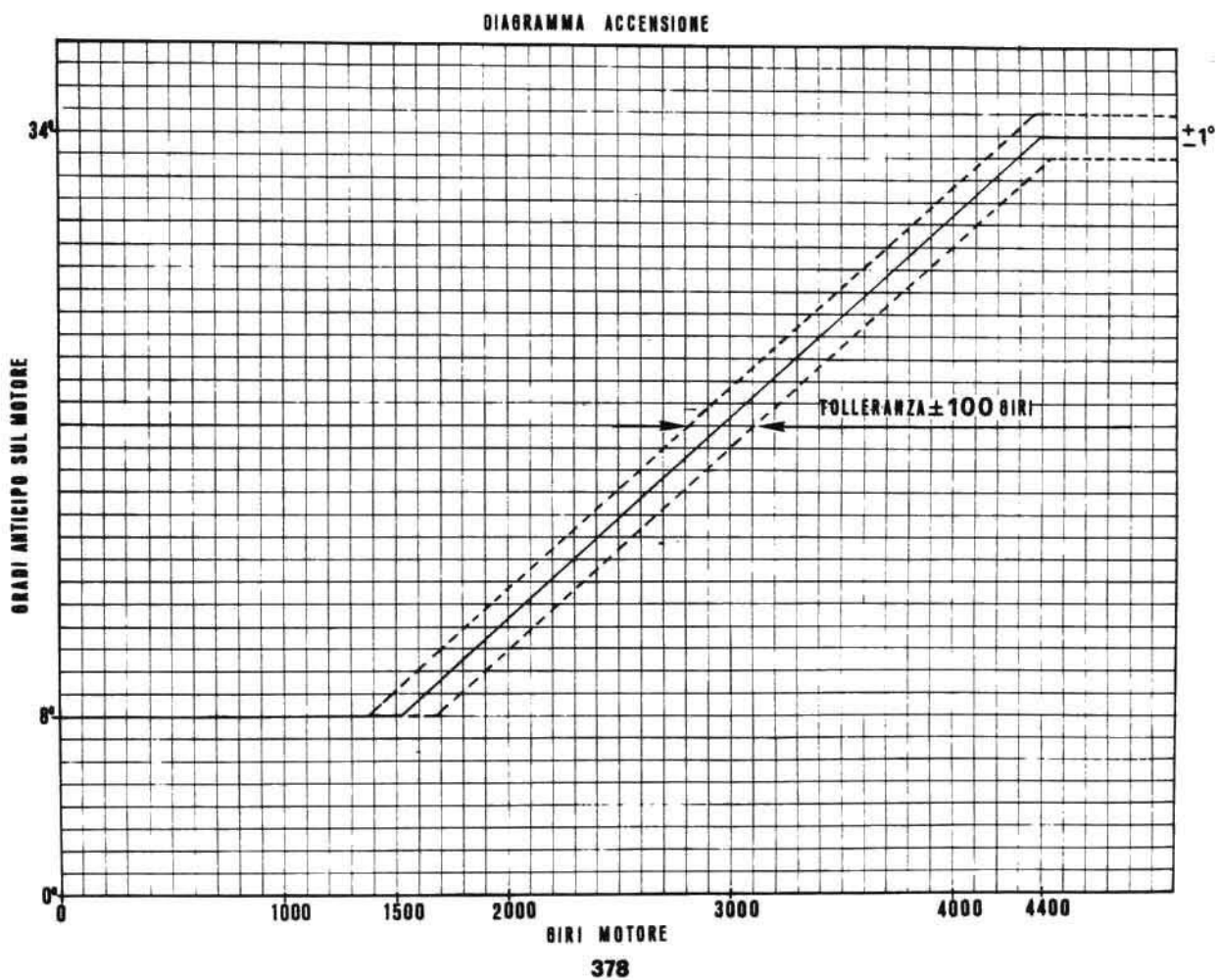

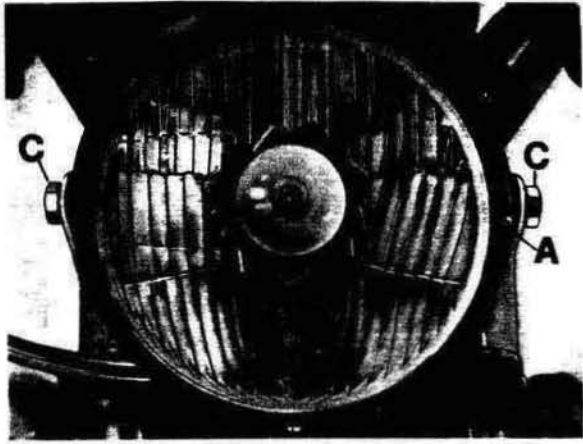

380

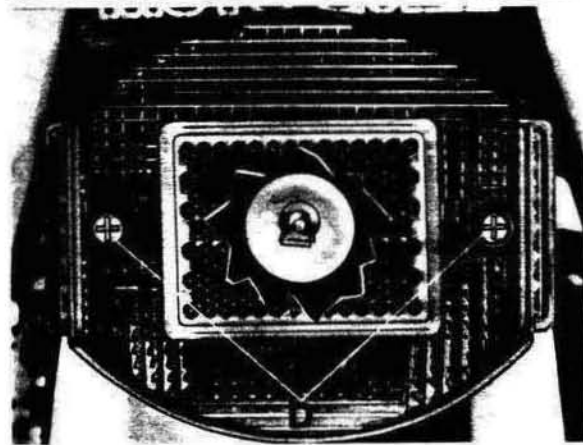

379

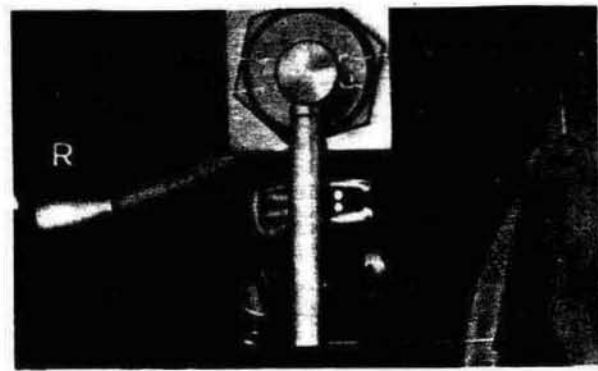

381

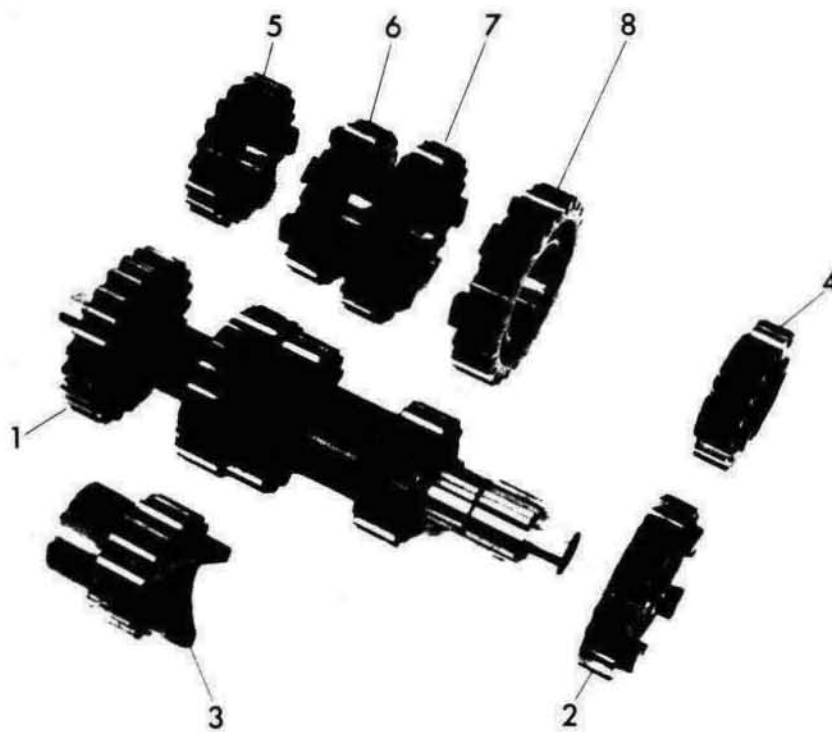

383

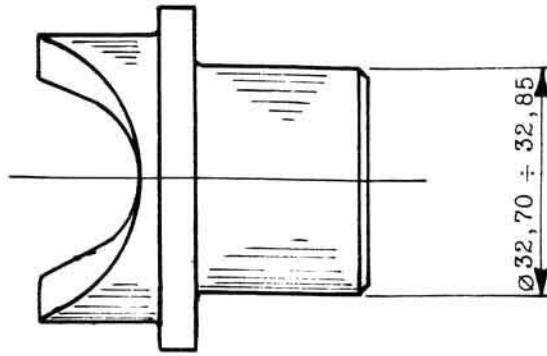

384

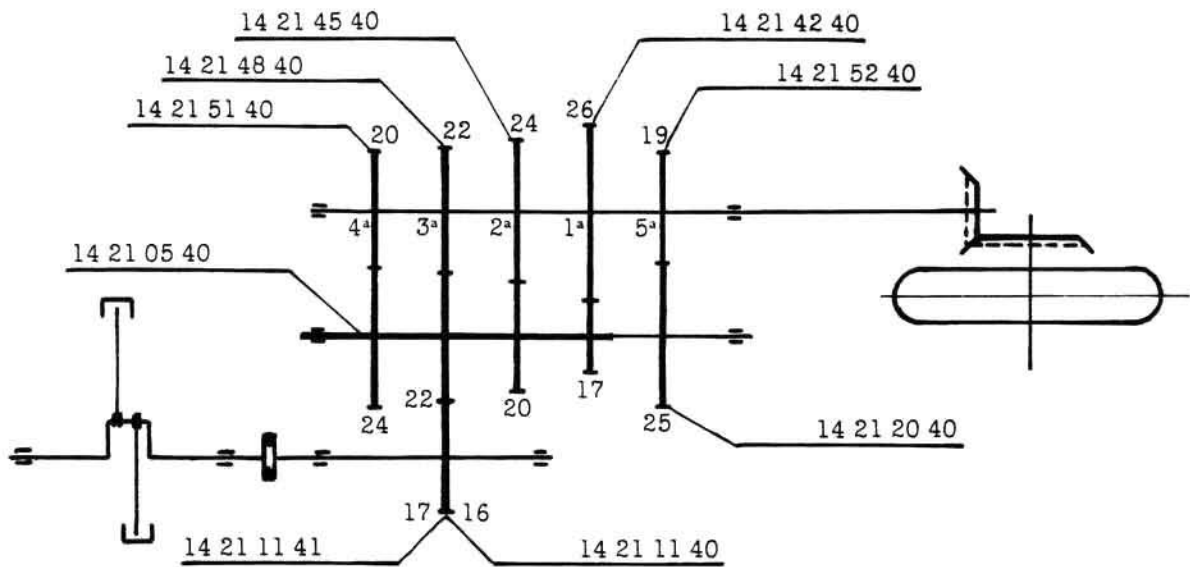

385

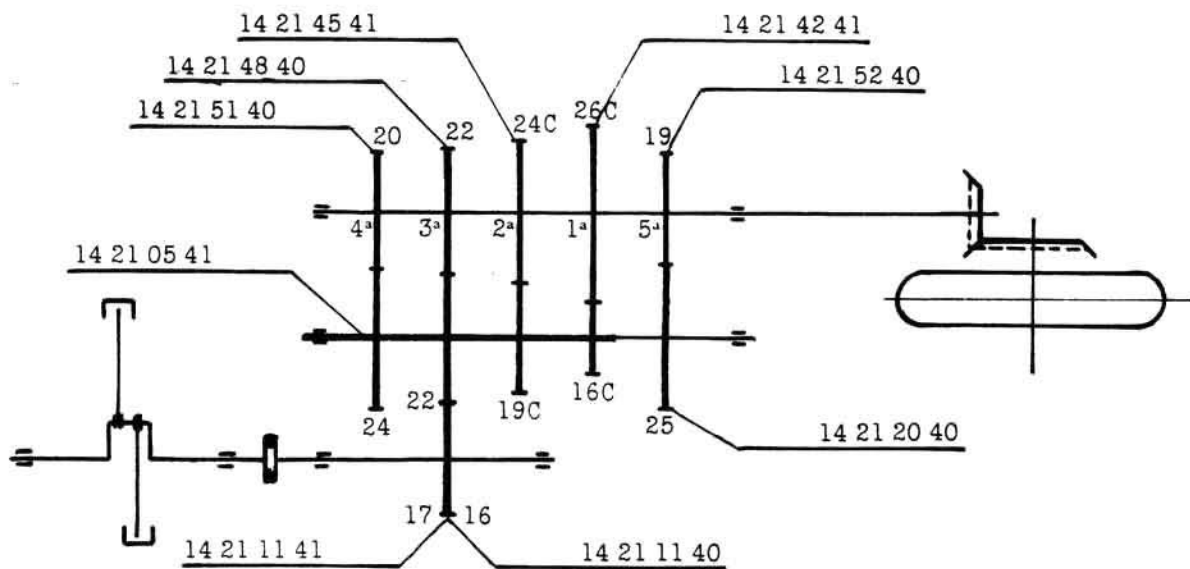

386

