

**SUPPLEMENT**  
to V700 and V750  
**WORKSHOP MANUAL**

**AMENDMENTS AND ADDITIONS**



**MOTO GUZZI**

## MAIN FEATURES V7 700 cc.

(page 5)

### ENGINE

Normal rocker clearance (cold engine):

- inlet 0,15 mm. (0,059")
- exhaust 0,25 mm. (0,098")

### Capacities

Fuel tank: 20 liters (5.28 US gls.) including about 4 liters reserve (about 1 USA gl) - Petrol 98/100 No (Regular octane) Sump 3 liters (3<sup>1</sup>/<sub>4</sub> Quarts).

Shell X 100 SAE 20 W/30 (Winter).

Shell X 100 SAE 40 W/50 (Summer)

Transmission 0.750 liter (1<sup>3</sup>/<sub>4</sub> Pints) Shell Spirax 90 E. P. - rear wheel drive 0.180 liters (0.4 Pints) Shell Spirax 90 E. P. - Front fork dampers 0.160 liters = 5,4 oz USA « Shell Tellus 33 ».

## MAIN FEATURES V7 700 cc.

(page 7)

### ENGINE

#### Carburation

2 dell'Orto carburetors type VHB 29 CD (right) and VHB 29 CS (left) both gravity fed from the tank.

#### Standard carburetor setting

- Choke 29 mm
- Throttle slide 60
- Atomizer 265
- Main jet 145
- Pilot jet 45
- Starter atomizer 80

With needle SV5 second notch from top.

Idling screw open 1<sup>1</sup>/<sub>2</sub> to 2 turns for the left carburetor and 2-2<sup>1</sup>/<sub>2</sub> turns for the right carburetor.

Air intake provided with dry filter.

#### Fuel and oil capacities

Fuel tank: 22.5 liters (5.84 US gls.) including about 4 liters reserve (about 1 US gl.) - Petrol 98 NO (Regular octane) - Sump 3 liters (3<sup>1</sup>/<sub>4</sub> quarts) Shell X 100 - 20 W/30 (winter) Shell X 100 - 40 W/50 (summer) - Transmission 0.750 liters (1<sup>3</sup>/<sub>4</sub> pints) Shell Spirax 90 E.P. - Rear wheel drive 0.180 liters (0.4 pints) Shell Spirax 90 E.P. - Front fork dampers 0.160 liters = 5.4 oz US Shell Tellus 33.

## VALVES - VALVE GUIDES COUPLING DATA

(page 19 - 20)

### INSPECTION OF VALVES

Check valves integrity and existing lash between stem and guide (for clearance refer to coupling data chart and Fig. 20). To regrind valves, insert valve stem in self-centering chuck of Universal Grinder (see Fig. 22) and adjust chuck swivel table so that valve will have an angle of inclination as follows:

**V7-700 cc.** (see fig. 20)

- inlet valve : 60° 25' 0
- + 15'
- exhaust valve : 45° 25' 0
- + 15'

**V7-750 cc.** (see fig. 21)

- inlet valve : 45° 30' ± 5'
- exhaust valve : 45° 30' ± 5'

After grinding, check that thickness of valve head at max, dia is not less than 0.8 mm. (.0315"). Should surface at stem end show any deformation, regrind same on grinding wheel.

Whenever regrinding valve seats, it is advisable to check that valve springs are compressed between:

**V7-700 cc.**

37 mm. and 38 mm. (1.456-1.496")

**V7-750 cc.**

36 mm. and 37 mm. (1.417-1.456").

Adjust by adopting suitable washers at bottom collar, between spring and cylinder head.

## CON-RODS

(page 26)

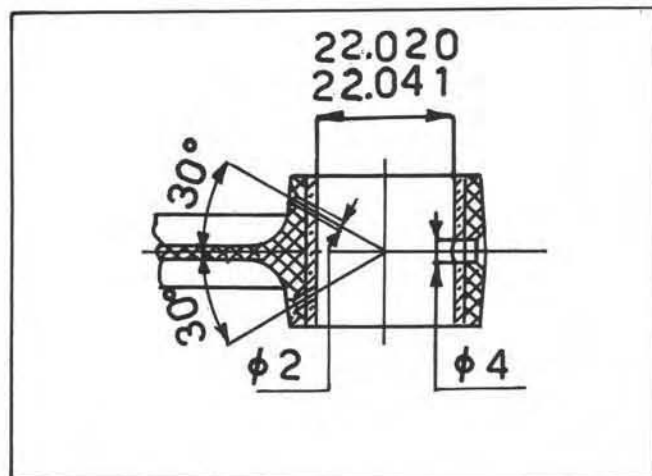

Fig. 34

## ENGINE LUBRICATION

(page 45)

### OIL BREATHER UNIT

If the motorcycle is left unused for any considerable length of time there is the possibility that foreign matter eventually present in the oil may deposit on the diaphragm inside the breather causing this to get stuck with consequent oil leakages.

Under the circumstances, we recommend to inspect this unit before using the machine again and this can be done by removing the unit from the machine with the fuel tank assembled.

Proceed as follows:

— Unscrew the breather unit securing bolt.

— Back out the breather from the left.

— Check that the pressure relief valve inside the breather can move freely. This can easily be done by means of a suitable rod introduced in the central tube of the breather. If the valve is stuck, free it with the rod and wash the tube out first with pure petrol and then with an oil-petrol mixture. Finally dry off with an air jet to prevent the valve from oxidizing and getting stuck again to the tube end from the engine.

The unit can now be re-assembled on the machine.

## ENGINE FEEDING

(page 51)

### STANDARD CARBURETOR SETTING (Fig. 71)

#### Standard carburetor setting

— Choke	:	29 mm
— Throttle slide	:	60
— Atomizer	:	265
— Main jet	:	145
— Pilot jet	:	45
— Starter atomizer	:	80

With needle SV5 second notch from top: idling screw open  $1\frac{1}{2}$  to 2 turns for the left carburetor and 2 -  $2\frac{1}{2}$  turns for the right carburetor.

### ADJUSTING THE CARBURATION (page 52)

3. Adjust the idling speed by acting on screw C in Fig. 71. Screwing this in reduces the fuel flow and viceversa increases it. To adjust, tighten and then turn screw out  $1\frac{1}{2}$  to 2 turns for the L/H carburetor and 2 to  $2\frac{1}{2}$  turns for the R/H carburetor.

With the engine running at about 1000-1200 r.p.m., disconnect one of the plug leads and turn screw C (Fig. 71) of the opposite carburetor in or out to the position which will give the best idling speed i.e. when the revs are slightly increasing.

## GEAR BOX

(see fig. 76-77 - page 58 - 59 - 60)

Separate case bolted on crankcase, constant mesh gear, frontal engagement.

Engine-gearbox ratio . . . . . 1:1.375 (16-22)

Internal gear ratios:

— Low gear . . . . . 1:2.230 (13-29)

— second gear . . . . . 1:2.333 (18-24)

— Third gear . . . . . 1:0.954 (22-21)

— Top gear . . . . . 1:0.750 (24-18)

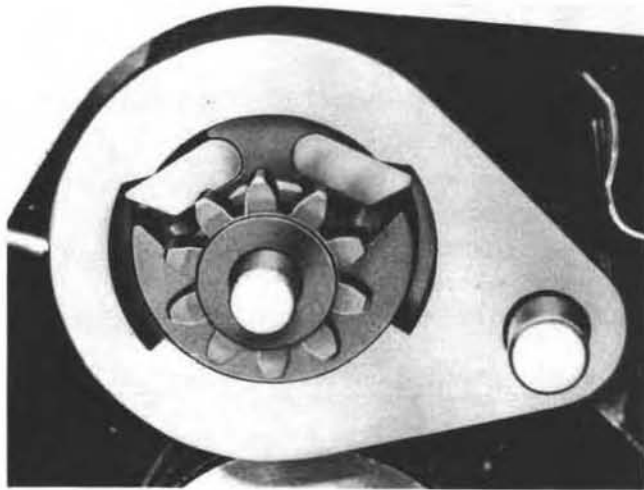

Fig. 80

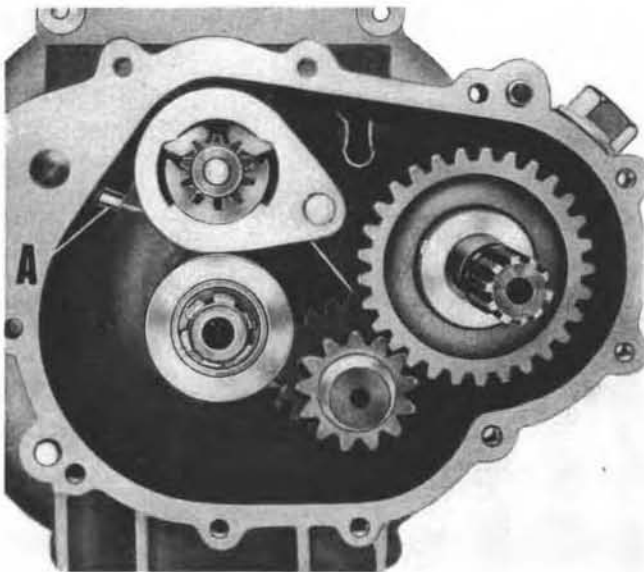

Fig. 81

### CHECKING THE GEAR OPERATING MECHANISM

(see Fig. 87/1 - Page 64)

In case of noisy gear shift, it is well to check and adjust the operating quadrant which drives the selector drum.

This is done by loosening lock nut (B) and screwing in or out the eccentric (A) to find the position where it is felt that by changing up and down all gears engage smoothly and the free position is easily selected.

Locknut (B) is then re-tightened keeping a fast hold on screw (A) by means of a screwdriver.

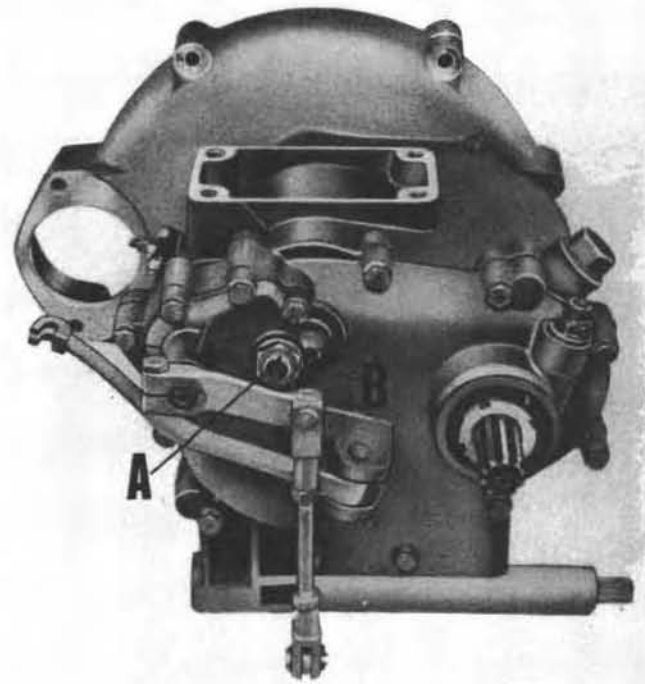

Fig. 87/1



## ELECTRICAL EQUIPMENT BATTERY

### Putting the dry charged battery

#### In service

1. Break off the seal and unscrew the plug.
2. Introduce pure sulphuric acid of 1275 sp.g. - temperature 15° (31° Baumé).

This operation has to be carried out very carefully and particular attention should be paid to the specific gravity of the recommended liquid.

The correct electrolyte level is 6 mm. over the plate separators (.23").

3. Let the battery at rest for about 2 hours and then top up with electrolyte to the recommended level.

The battery can now be charged for 8-15 hours at a current intensity equal to 1/10th of its normal amperage (in 10 hours discharge).

4. The battery is now ready to be put in service.

#### Maintenance instructions

During the period that the battery is left at rest before use, ensure the electrolyte level is about

6 mm. (.23") over the top of the plate separators.

Ensure that this level is maintained at all times with the addition of distilled water. Never add sulphuric acid.

If the battery is not used immediately, it is best to have it charged for a short period every month or every time before it is used.

#### Successive charges

Before re-charging make absolutely certain that the battery is in a perfectly clean condition.

Connect to the charging medium and use preferably an amperage equal to but not exceeding 1/10th of the rated battery capacity over a period of 10 hours.

If during the charge the electrolyte temperature (measured with a thermometer immersed in the electrolyte) should get up to 50°C (122°F), it will be necessary to reduce or interrupt the charge until the temperature has dropped to under 40°C (104°F).

**Never add sulphuric acid** but top up only with chemically pure distilled water.

## INSTRUMENTS AND CONTROLS

(page 124)

### INSTRUMENT PANEL (See fig. 128/1)

1. Speedometer.
2. Green town driving light on European model.  
Red on USA model indicating lights on.
3. Red warning light indicating insufficient flow of current from generator for battery charge. Should go out when the engine has reached a certain number of revolutions.
4. Orange. This is the neutral indicator light. Is not lighted when any gear is engaged.
5. Red warning light. Oil pressure gauge. Will go out when oil pressure for normal engine operation is sufficient.
6. Revolution counter.



Fig. 128/1

### IGNITION KEY (See Fig. 128/2)

This key has 3 positions:

- « 0 » Machine at standstill, key removable, all electrics switched off.
- « 1 » Machine standing, key removable, parking lights on.
- « 2 » Running position or machine ready to set out. All controls on. For daylight driving no other position necessary. For night driving levers A and B on the left handlebar must be switched on.

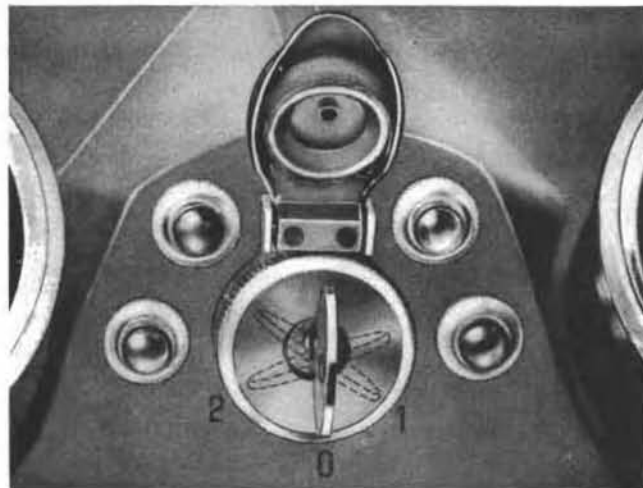

Fig. 128/2

### STARTING BUTTON (See Fig. 128/3)

On right handlebar. With the ignition key in position 2 the machine is ready to be started.



Fig. 128/3

**STEERING LOCK** (See Fig. 129/1)

It is located on the L/H side of the steering column (See A) and it is key operated.

To lock, turn the handlebar completely to the right and insert the key turning it forward (toward the front wheel). Push it in, release it and pull it out. To open: Insert key in the lock, turn it forward, and release it.

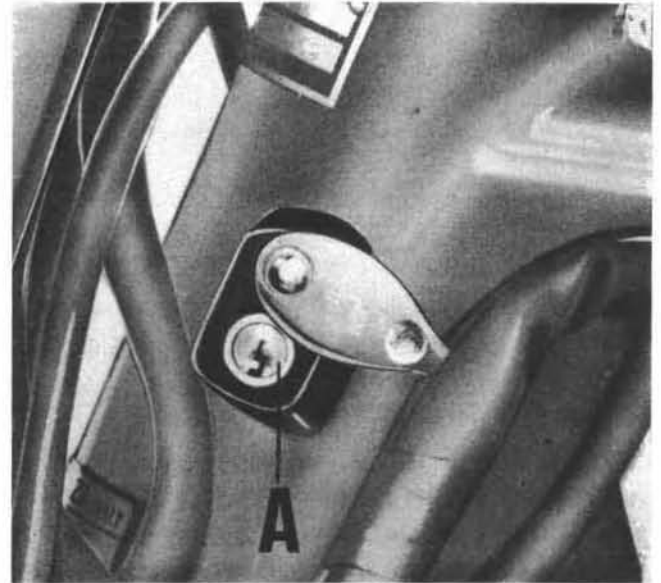

Fig. 129/1



WIRING DIAGRAM - EUROPEAN MODEL

Legend

- A HEADLIGHT
- B MAIN LIGHT BULB
- C TERMINAL BLOCK WITH FUSES
- D DISTRIBUTING BLOCK
- E LIGHT SWITCH AND HORN BUTTON
- F SPARK PLUG
- G DISTRIBUTOR
- H CONTACT BREAKER
- I H.T. COIL
- L STARTER BUTTON
- M HORN
- N NEUTRAL INDICATOR CUTOUT
- O STOP LIGHT
- P OIL PRESSURE CUTOFF
- Q IGNITION SWITCH
- R NUMBER PLATE AND TAIL LIGHT
- S PLATE ILLUMINATION
- T GENERATOR
- U REGULATOR
- V BATTERY
- Z STARTER MOTOR SOLENOID
- X STARTER MOTOR
- AA SPEEDOMETER WITH ILLUMINATION BULB
- BB REV-COUNTER
- CC LIGHTS INDICATOR (red)
- DD NEUTRAL INDICATOR (orange)
- EE CHARGE INDICATOR (red)
- FF OIL PRESSURE INDICATOR (red)
- GG PARKING LIGHT
- K RELAY FOR STARTER SOLENOID

IGNITION SWITCH POSITION

- 0 - 0
  - 1 - 30/30 - INT
  - 2 - 30/30 - INT 15/54
  - 3 - 30/30 - INT 15/54 - 50
- MB.: Position - 3 - does not serve on machines with starter button.

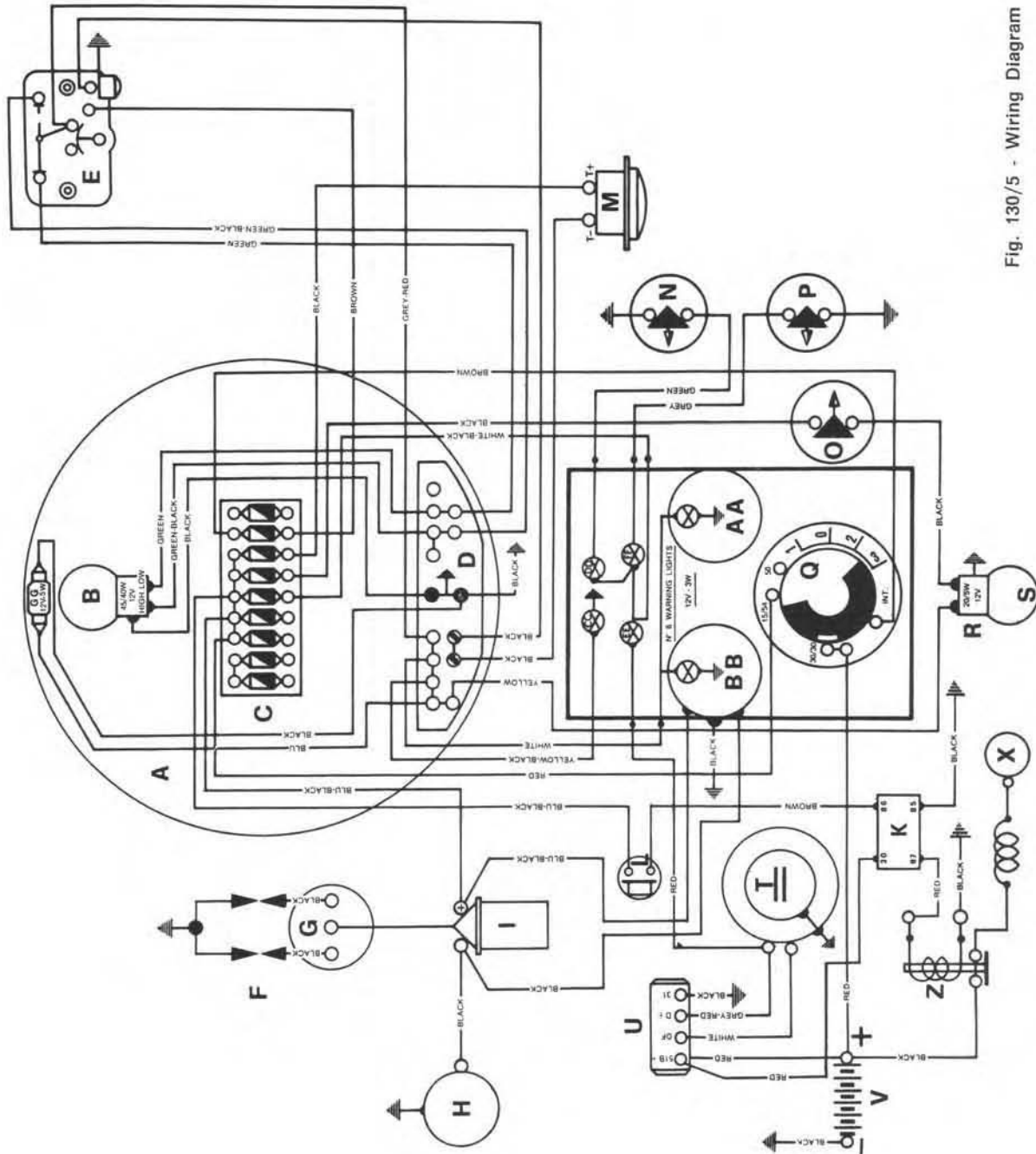

Fig. 130/5 - Wiring Diagram V7-750 (European Model)



WIRING DIAGRAM - US MODEL

Legend:

- A HEADLIGHT
- B MAIN DRIVING LIGHTS
- C TERMINAL BLOCK WITH FUSES
- D DISTRIBUTING BLOCK
- E LIGHT SWITCH AND HORN BUTTON
- F SPARK PLUGS
- G DISTRIBUTOR
- H CONTACT BREAKER
- I H.T. COIL
- L STARTER BUTTON
- M HORN
- N NEUTRAL INDICATOR CUTOFF
- O STOP LIGHT CUTOFF
- P OIL PRESSURE CUTOFF
- Q IGNITION SWITCH
- R NUMBER PLATE AND TAIL LIGHT
- S PLATE ILLUMINATION AND STOP LIGHT
- T GENERATOR
- U REGULATOR
- V BATTERY
- Z STARTER MOTOR SOLENOID
- X STARTER MOTOR
- AA SPEEDOMETER (with illumination bulb)
- BB REV-COUNTER (with illumination bulb)
- CC LIGHTS INDICATOR (red)
- DD NEUTRAL INDICATOR (orange)
- EE GENERATOR CHARGE INDICATOR (red)
- FF OIL PRESSURE INDICATOR (red)
- K RELAY FOR STARTER SOLENOID

IGNITION SWITCH POSITION

- 0 = 30:30 - INT.
  - 1 = 30:30 - INT. 15:54
  - 2 = 30:30 - INT. 15:54
  - 3 = 30:30 - INT. 15:54 - 50
- NB.: Position - 3 - does not serve on machines with starter button

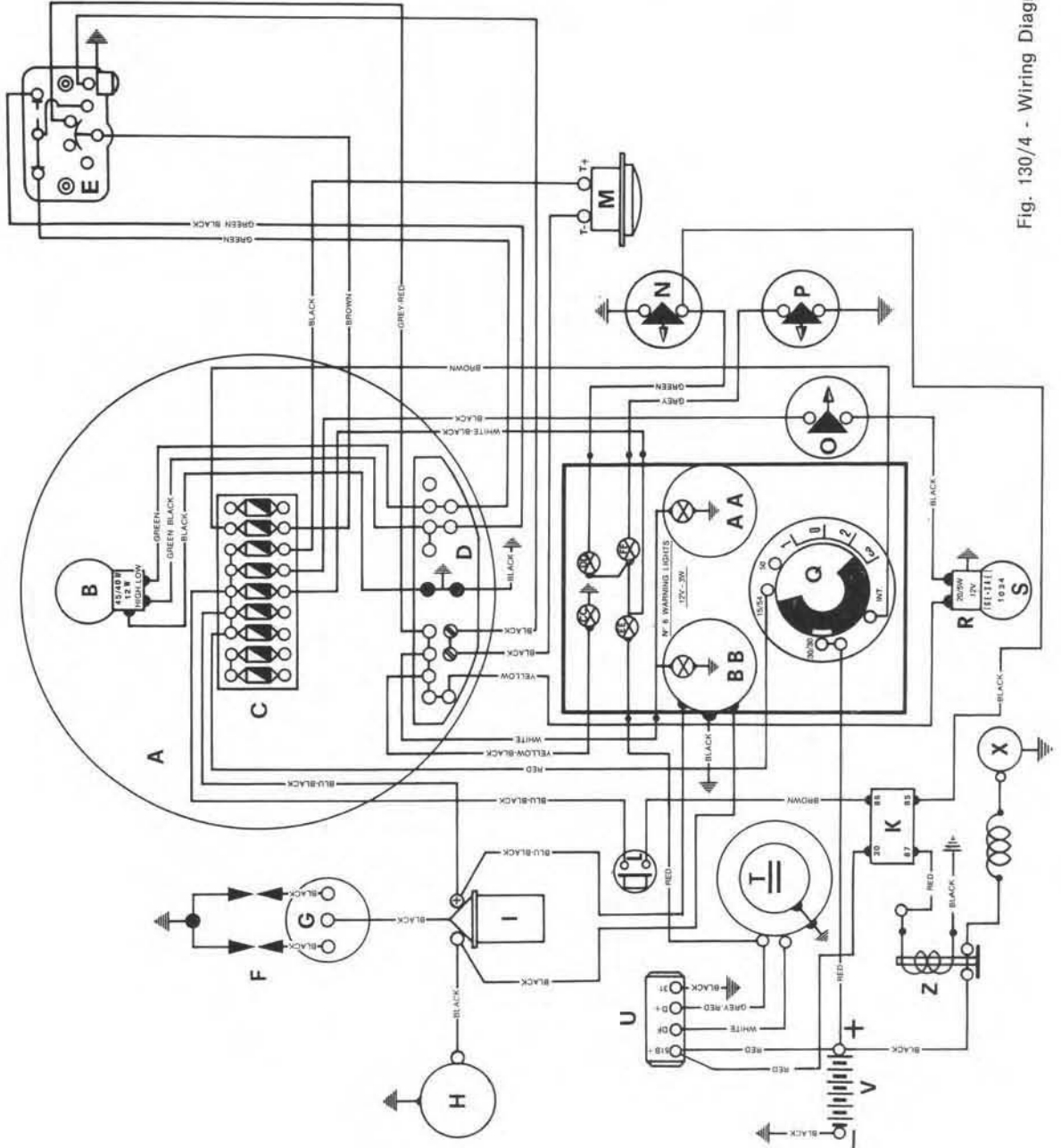

Fig. 130/4 - Wiring Diagram V7-750 (Usa Model)

