



**rider's
handbook**

SEIMM

SOCIETÀ ESERCIZIO INDUSTRIE MOTOMECCANICHE S.p.A.

Capitale sociale sottoscritto: L. 465.000.000

Sede legale: Milano

Galleria de Cristofori, 3 - Telefono 709965

Direzione e Stabilimenti: 22054 Mandello del Lario (Co)

Telefoni: 71112 e 72512 (8 linee urbana)

Telegrammi: SEIMM MANDELLOLARIO



MOTO GUZZI

Ambassador

V 750

RIDER'S HANDBOOK

INTRODUCTION This booklet is intended to provide owners with the necessary information on operating and maintaining their machines for maximum efficiency.

The manual should be read very carefully as most troubles and failures arising from neglect or poor maintenance will be avoided if all the instructions herein contained are strictly followed.

Don't forget that all major overhaul jobs and repairs are best carried out by officially appointed Moto Guzzi dealers who have the necessary facilities to quickly and competently repair your Moto Guzzi.

INDEX

	Page
Running in	5
Controls and accessories	» 6
Identification data	» 10
Tool kit	» 11
Main features - Engine	» 12
Frame	» 16
Instruments and controls	» 18
Ignition key	» 19
Starting button	» 19
Ignition switch keys	» 20
Steering lock	» 20
Steering lock keys	» 20
Dimmer switch and horn button	» 20
Clutch lever	» 20
Twist grip throttle control	» 20
Air lever	» 21
Gearshift lever	» 21
Front brake lever	» 21
Rear brake pedal	» 21
Riding instructions	» 22
Lubrication chart	» 25
Lubrication and general maintenance	» 27
Servicing instructions	» 29
Lubrication of engine	» 29
Oil pressure relief valve	» 31
Oil pressure gauge	» 31
Lubrication of transmission	» 31
Lubrication of rear wheel drive	» 32
Lubrication of front fork and hydraulic dampers	» 33
Lubrication of bevels in the steering	» 33

Lubrication of wheel bearings	page 33
Lubrication of rear fork bearings	» 33
Carburation	» 35
Air filter	» 40
Fuel tank	» 40
Fuel taps	» 41
Mufflers	» 42
Valve gearing	» 43
Tappet clearance	» 43
Checking valve riming	» 43
Ignition	» 46
Distributor	» 46
Spark plugs	» 47
Checking of ignition timing	» 47
Checking of ignition advance by stroboscope lamp	» 48
Adjustments	» 51
Generator belt	» 51
Clutch lever	» 51
Steering	» 51
Steering lock	» 54
Front brake lever	» 55
Rear brake pedal	» 57
Rear suspension units	» 57
Removal of wheels	» 60
Front wheel	» 60
Rear wheel	» 60
Electrical equipment	» 62
Wiring diagram - USA model	» 71
Wiring diagram - European model	» 72

RUNNING IN

During the first 1600 kms. (1000 miles), a new or overhauled machine ought to be used with some intelligence as the efficiency, performance, and life of the engine are largely dependant on how it is run in.

The engine should never be allowed to reach a high number of revolutions before it has had a chance to warm up sufficiently. Never ride the machine at the highest permissible speeds for each gear before the machine has been well broken in.

Should the engine speed drop off considerably on an uphill grade, a lower gear should be immediately engaged. In case of overheating, it is best to stop and allow the engine to cool down.

Under no circumstances whatever should the following speeds be exceeded in the running in period.

Maximum permissible speeds:

Distance: up to 800 kms. (500 miles):

in low gear 45 kms. (28 miles)
in second gear 65 kms. (40.5 miles)
in third gear 85 kms. (53 miles)
in high gear 110 kms. (68 miles)

from 800 to 1600 kms. (500 to 1000 miles):
in low gear 55 kms. (34.5 miles)
in second gear 80 kms. (50 miles)
in third gear 105 kms. (65 miles)
in high gear 135 kms. (84 miles)

From 1600 to 3000 kms. (1000 to 1800 miles) the speed can be gradually increased up to the maximum permissible limits.

After the first 500 kms. (300 miles)

Change the engine oil.
Tighten all nuts and bolts.
Check valve clearance.
Check distributor points.

Every 500 kms. (300 miles)

Check oil level. Correct level is in between the minimum and maximum mark on the filler cap dipstick.

CONTROLS AND ACCESSORIES

(See fig. 1)

1. Front brake lever
2. Air control lever
3. Throttle control grip
4. Starter button
5. Filler cap
6. Gearshift lever
7. Pillion footrests
8. Pillion handgrip
9. Headlight
10. Speedometer
11. Ignition key
12. Rev-counter
13. Clutch lever
14. Light switch and horn button
15. Side stand
16. Rear brake pedal
17. Footrests
18. Center stand
19. Tail light

The machine can also be supplied with gear-shift lever on the left and rear brake pedal on the right.

N.B. - The terms « right » and « left » in the text are used in the sense they would appear to one sitting in the saddle.

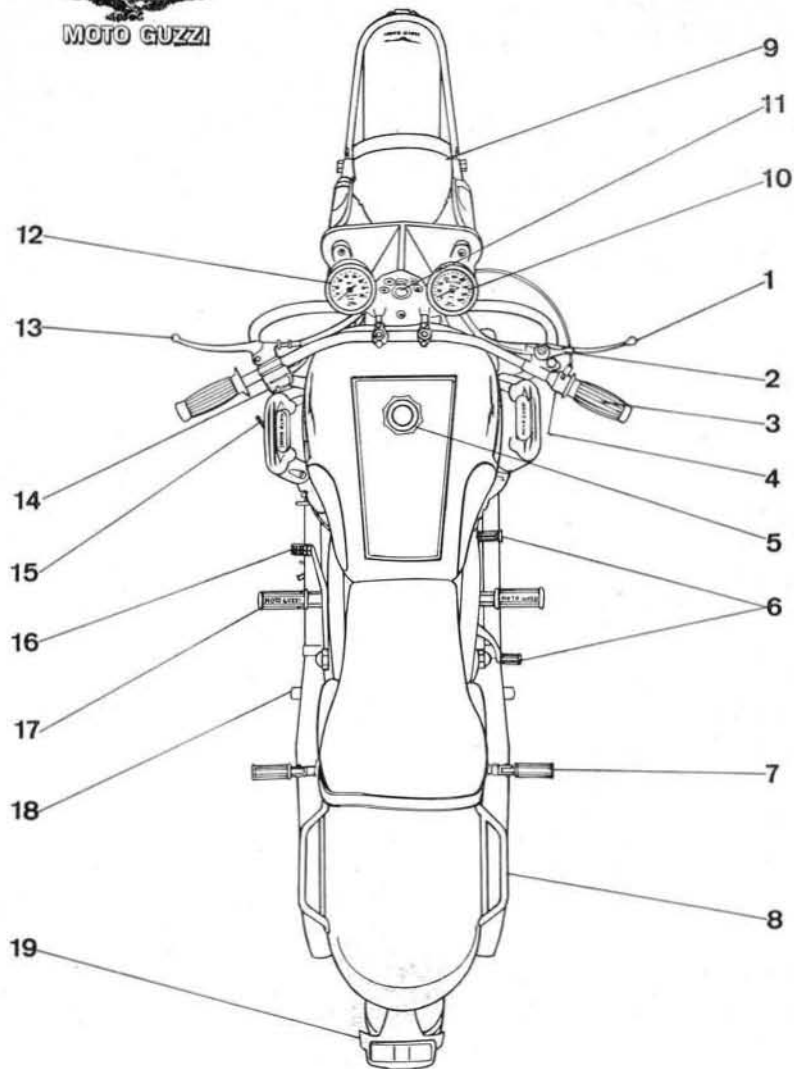

Fig. 1

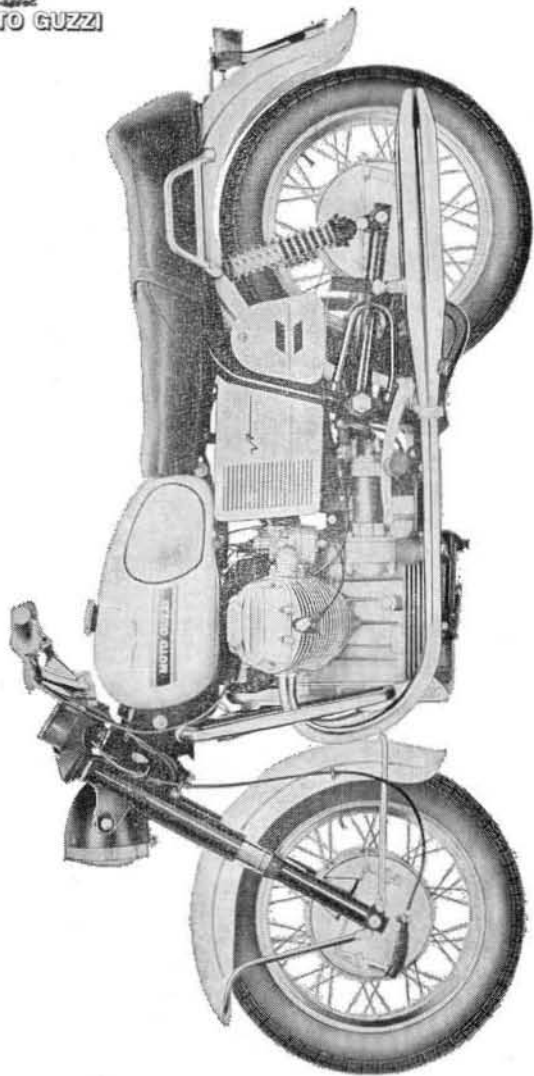

Fig. 2 - Left view

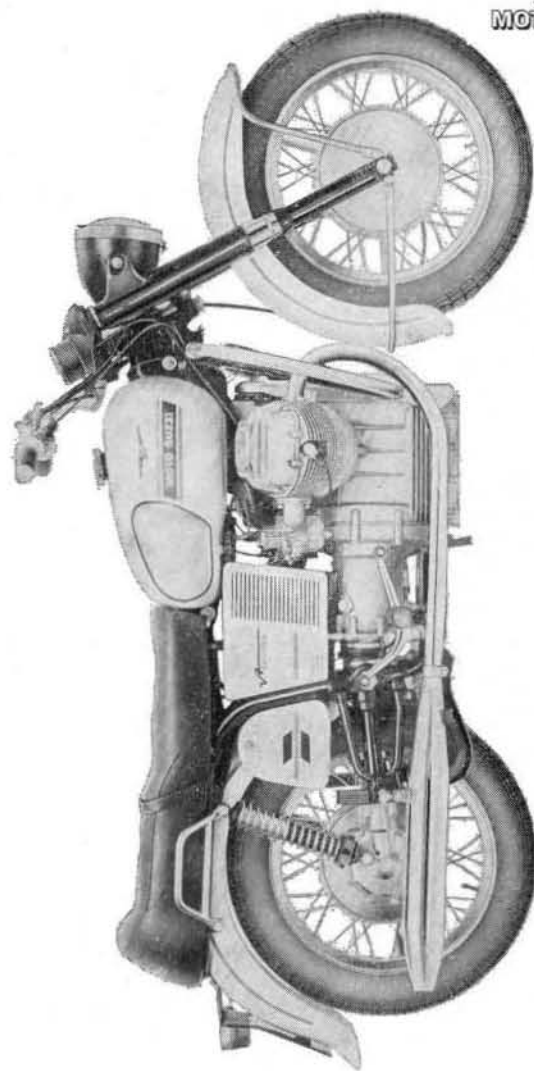

Fig. 3 - Right view

Identification data

(See fig. 4)

Every machine is identified with a serial number which is stamped on the frame down tube and on the left hand crankcase cover.

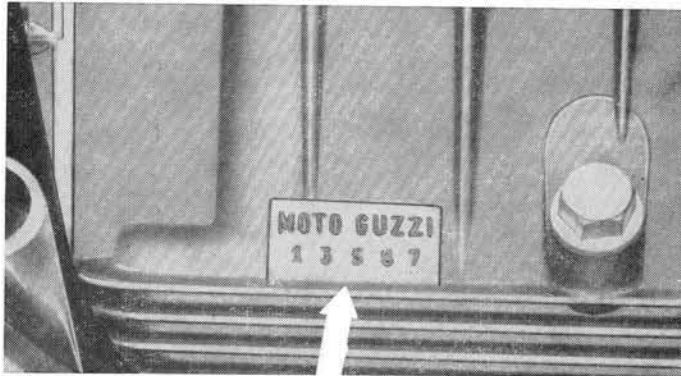
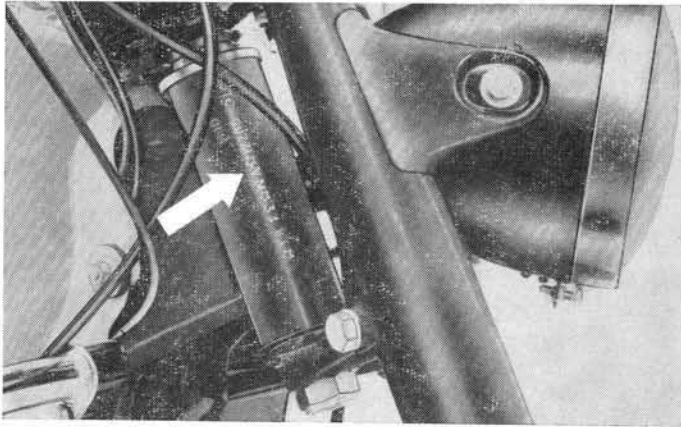

Fig. 4

Tool kit

(See fig. 5)

1. Box wrench, 19-21-22 mm.
2. Open ended wrench, 17-19 mm.
3. Open ended wrench, 10-11 mm.
4. Tappet adjusting wrench
5. Box wrench, 8-9 mm.
6. Allen key (5 hex)
7. Box wrench, 10-14 mm.
8. Universal pliers
9. Adjustable wrench
10. Screwdriver
11. Ring wrench, 27 mm.
12. Rear damper adjusting wrench
13. Tool bag

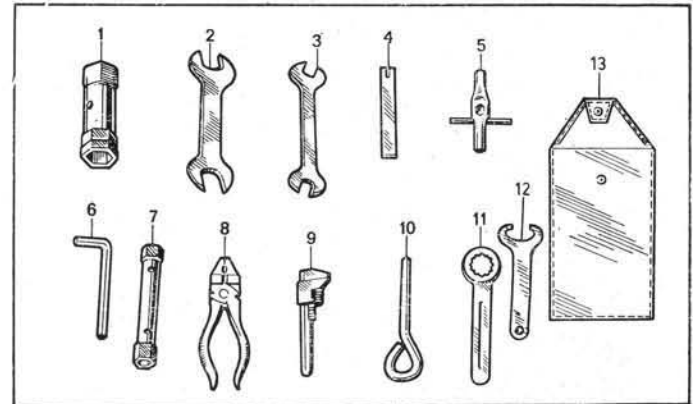

Fig. 5

MAIN FEATURES

ENGINE

(See fig. 5/1)

Cycle	: 4 strokes
Number of cylinders	: 2
Cylinder disposition	: « V » 90°
Bore	: 83 mm. (3.26")
Stroke	: 70 mm. (2.75")
Displacement	: 757.486 cc. (46.21 cu.in.)

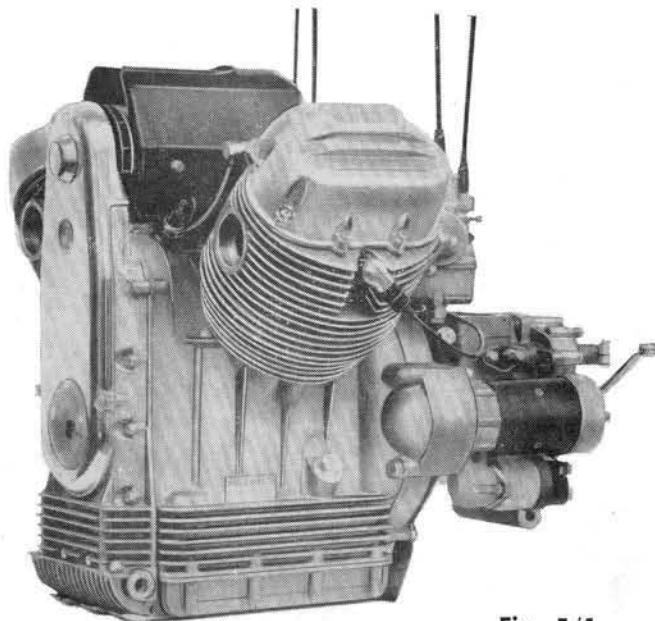

Fig. 5/1

Compression ratio:	9 to 1
Revs at maximum engine speed	: 6500 r.p.m.
Output at maximum engine speed	: 60 HP SAE
Crankcase	: in light alloy
Cylinders	: in light alloy with hard chromed barrels
Cylinder heads	: in light alloy, hemispherical, with special cast iron inserted seats.
Crankshaft	: steel construction
Crankshaft supports	: in anti-friction material pressed in 2 suitable housings (as used in all F1 race cars)
Connecting rods	: steel construction with AL-TIN alloy thin wall bearings
Pistons	: in light alloy
Valve gear	O.H.V., push rod operated via the camshaft in the crankcase and gear driven by the crankshaft.
Inlet:	
— opens	24° before TDC
— closes	58° after BDC
Exhaust:	
— opens	58° after BDC
— closes	22° after TDC
Rocker clearance for valve timing:	
—	0.5 mm. (.0196")
Normal rocker clearance (cold engine):	
— inlet	0.15 mm. (.0059")
— exhaust	0.25 mm. (.0098")



Carburation

2 Dell'Orto carburetors type VHB 29 CD (right) and VHB 29 CS (left) both gravity fed from the tank.

Standard carburetor setting

- Choke : 29 mm.
- Throttle slide : 60
- Atomizer : 265
- Main jet : 145
- Pilot jet : 45
- Starter atomizer : 80

With needle SV9 set at second notch from top: idling screw open 1 and 1/2 turns for the left carburetor and 1 and 3/4 - 2 turns for the right carburetor.

With needle SV5 third notch from top: idling screw open 1 1/2 to 2 turns for the left carburetor and 2-2 1/2 turns for the right carburetor.

Air intake provided with dry filter.

Lubrication

Pressure, by gear pump driven by the crankshaft.

Oil strainer in crankcase.

Normal lubrication pressure 3.8 - 4.2 kgs/sq. cm. (54 to 60 lbs sq.in.) controlled by relief valve.

Electrically controlled oil pressure gauge.

Cooling

By air. Cylinder and cylinder head deeply finned.

Ignition

By battery with automatic advance distributor.

Initial advance: 10°.

Automatic advance: 28°.

Ignition timing 38° full advance.



Contact breaker gap: 0.42-0.48 mm. (.016" - .018").

Spark plug: n. 225 in Bosch-Marelli scale or equivalent.

Plugs point gap: 0.6 mm. (.023")
Ignition coil.

Starting

Electric starter with electromagnetic ratchet control.

Ring gear bolted on flywheel. Operated by starter button.

Exhaust system

Dual exhaust pipes and mufflers.

TRANSMISSION

Clutch

Twin driven plates, dry type, located on the flywheel. Controlled by lever on left handlebar.

Gear box

Four speeds, frontal engagement. Constant mesh gears. Cush drive incorporated.

Separate case bolted on crankcase, operated by rocker pedal on the right side of the machine.

Engine gear-box ratio: 1 to 1.375 (16-22)

Internal gear ratios:

- Low gear 1 to 2.230 (13-29)
- Second gear 1 to 1.333 (18-24)
- Third gear 1 to 0.954 (22-21)
- High gear 1 to 0.750 (24-18)

Secondary drive

By constant speed double joint cardan shaft Layshaft bevel gears-rear wheel ratio:

4.375 (8-35)

Overall gear ratios:

- Low gear 1 to 13.415
- Second gear 1 to 8.018
- Third gear 1 to 5.738
- High gear 1 to 4.511



FRAME	Duplex cradle, tubular structure.
Suspension	Telescopic front fork incorporating hydraulic dampers. Rear swinging fork with externally adjustable springs.
Wheels	18x3 rims, front and rear.
Tires	4.00x18 front and rear, block type (high speed).
Tire pressure	Front tire: solo with passenger } 1.5 kgs/sq.cm. = 21 p.s.i. Rear tire: solo 1.8 kgs/sq.cm. = 25 p.s.i. with passenger 2.0 kgs/sq.cm. = 28 p.s.i. N.B. - The above recommendation is for normal riding (cruising speed). If using the machine at constant high speed or on motorways, the above pressures should be increased by 0.2 kgs/sq.cm. (2.8 p.s.i.).
Brakes	Twin leading shoes front brake operated by hand lever on the right handlebar. Large rear brake operated on left hand side of machine.
Overall dimensions and weight	Wheelbase 1.470 mts. (about 57.8") Length 2.245 mts. (about 88.3") Width 0.830 mts. (about 32.6") Height (dry) 1.070 mts. (about 42.1") Minimum ground clearance 0.150 mts. (about 5.9") Curb weight 228 kgs. (about 502 lbs.)



Performance	Maximum permissible speeds and gradients climbable in each gear, solo riding. Low gear: 62 kms/h (38.5 m.p.h.) climbing ability: 90% Second gear: 104.250 kms/h (64.6 m.p.h.) climbing ability: 40% Third gear: 145.250 kms/h (89.2 m.p.h.) climbing ability: 20% High gear: 185.276 kms/h (115 m.p.h.) climbing ability: 8%
Fuel consumption	Measured according to CUNA standards: 37 m.p.g. (US).
Fuel and oil capacities	Fuel tank: 22.5 liters (5.84 US gls.) including about 4 liters reserve (about 1 US gl.). Petrol 98 NO (Regular octane) - Sump 3 liters (3¼ quarts) Shell Super Motor Oil 100 - Transmission 0.750 liters (1¾ pints) Shell Spirax 90 E.P. - Rear wheel drive 0.300 liters (5/8 pints) Shell Spirax 90 E.P. - Front fork dampers 0.160 liters = 5.4 oz US Shell Tellux 33.

INSTRUMENTS AND CONTROLS

Instrument panel

(See fig. 6)

1. Speedometer.
2. Town driving light (green).
3. Red warning light indicating insufficient flow of current from generator for battery charge. Should go out when the engine has reached a certain number of revolutions.
4. Orange. This is the neutral indicator light. Is not lighted when any gear is engaged.
5. Red warning light. Oil pressure gauge. Will go out when oil pressure for normal engine operation is sufficient.
6. Revolution counter.

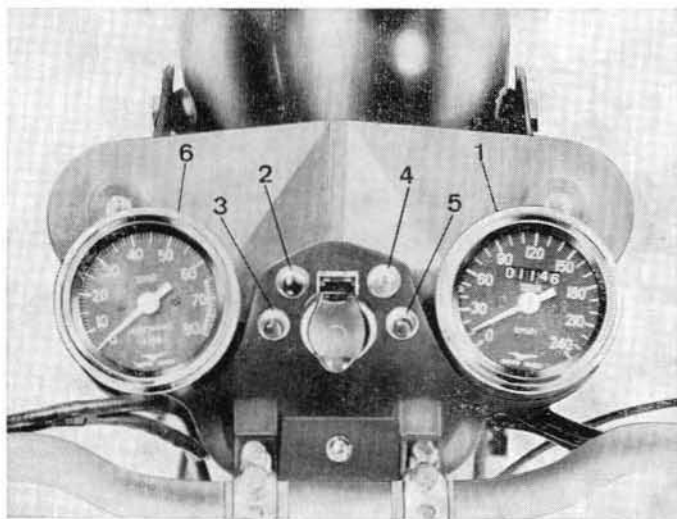

Fig. 6

Ignition key (Fig. 6/1)

This key has 3 positions:

- « 0 » Machine at standstill, key removable, all electrics switched off.
- « 1 » Machine standing, key removable, parking lights on.
- « 2 » Running position or machine ready to set out. All controls on. For daylight driving no other position necessary. For night driving levers A and B on the left handlebar must be switched on (Fig. 7).

Starting button (Fig. 6/2)

On right handlebar with the ignition key in position 2 the machine is ready to be started.

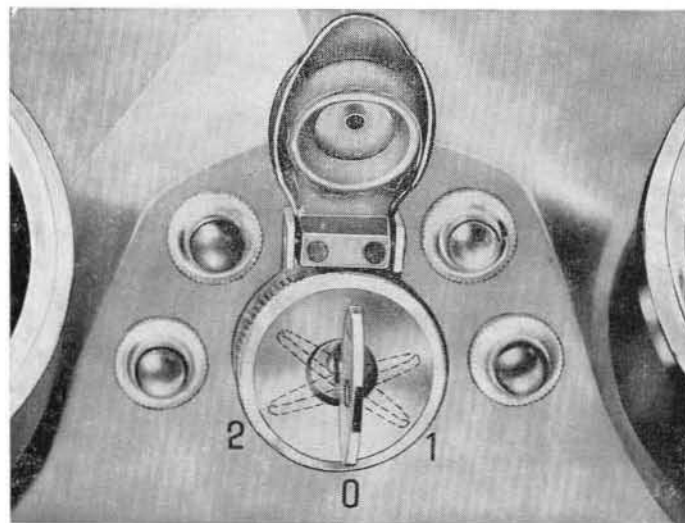

Fig. 6/1

Ignition switch keys

Every machine is supplied with an ignition key and a duplicate. Key number should be recorded and reported to your dealer in case of loss.

Steering lock
(Fig. 22/1)

It is located on the left hand side of the steering column and it is key operated.

Steering lock keys

Every machine is supplied with a key and a duplicate. Key number should be recorded and reported to your dealer in case of loss.

Dimmer switch and horn button
(Fig. 7)

It is located on the left handlebar.

- a) position « 0 »: lights off;
- position « 1 »: parking light (town driving light);
- position « 2 »: low beam;
- b) position « 3 »: low beam; } dimmer
- position « 4 »: high beam; } switch
- c) horn button.

Clutch lever

Is on left handlebar and should be used for starting and gearshifting only.

Twist grip throttle control

It is located on the right handlebar. Throttle is opened by turning toward the rider.

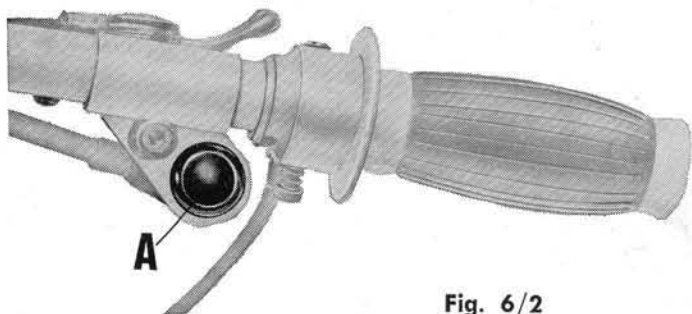

Fig. 6/2

Air lever

Is on the right hand side of the handlebar. It is opened by pulling toward the rider and viceversa.

Gearshift lever

On right hand side of machine or on left if required.

Front brake lever

On right hand side of machine.

Rear brake pedal

On left hand side of machine or on right if required.

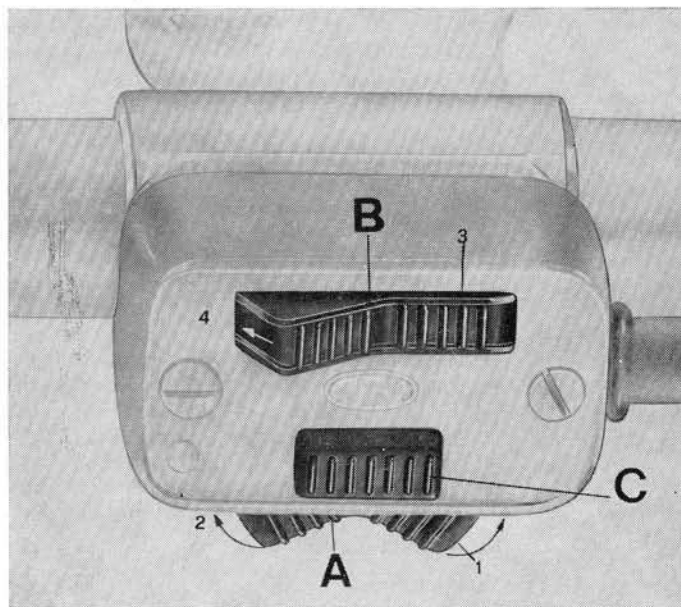

Fig. 7

RIDING INSTRUCTIONS

Engine starting

Ensure there is sufficient fuel in the tank and that the crankcase oil is at correct level. Insert the ignition key and switch it on to position 2 (fig. 6/1), ensuring that the red oil pressure light and the orange neutral indicator light are on. If the engine is started from cold, ensure that the easy starting air control is opened and then push the starter button on the right hand side of the handlebar.

When the engine has started, release the starting button and allow the engine to idle for a short time in the cold season to give a chance to the oil to warm up and reach all the lubricating points. Then close the easy starting air control. If this is left open, there will be excessive petrol consumption and irregular carburation.

Caution

Attempting to start the engine in gear can be very dangerous unless the clutch lever is kept fully disengaged as with the firing of the engine the machine itself may start off. Even at very low temperatures, the engine should always start easily, provided there is sufficient thrust from the starter motor and everything is in good running order.

If the engine does not start easily, do not persist in many attempts, but check carburation, ignition, battery charge, and that the oil is not too heavy.

Starting a hot engine

When starting a hot engine there is no need to close the air lever as this would richen the mixture and make starting difficult. If starting a hot engine gives some difficulty,

it is well to open the throttle completely before pushing in the starter button.

Getting under way and stopping of machine

Pull the clutch lever completely, engage low gear, release the clutch slowly, and at the same time turn the gas on.

As soon as the engine has picked up some speed, close the gas, pull the clutch and by downward toe pressure engage second gear. Then release the clutch rapidly (but not with a jerk) and turn on the gas once more. Third and high gear are likewise engaged by toe pressure.

On the way

In normal riding conditions, all the tell-tale lights should be off, except naturally the green light when night driving in towns. If any one of them light up, this means there is some fault in the system or oil pressure is insufficient.

The maximum speeds in each gear should never be exceeded, not even on steep downhill grades. Do not forget that by toe pressure you pass to a higher gear and by heel pressure to a lower gear (Fig. 9). Before any gear is engaged, make sure the clutch is completely disengaged. It is necessary to fully close the gas when you change up but it can only be closed partially when changing down. To obtain fast and effortless gear shifts, always, depress the pedal firmly but gently without stamping or jabbing vigorously on it.

The free position (neutral) is in between first and second gear. To locate this position it is necessary to shift to low gear and then by slight (toe) pressure (half stroke) to feel for neutral position.

With the machine standing still and the engine running, the transmission should always

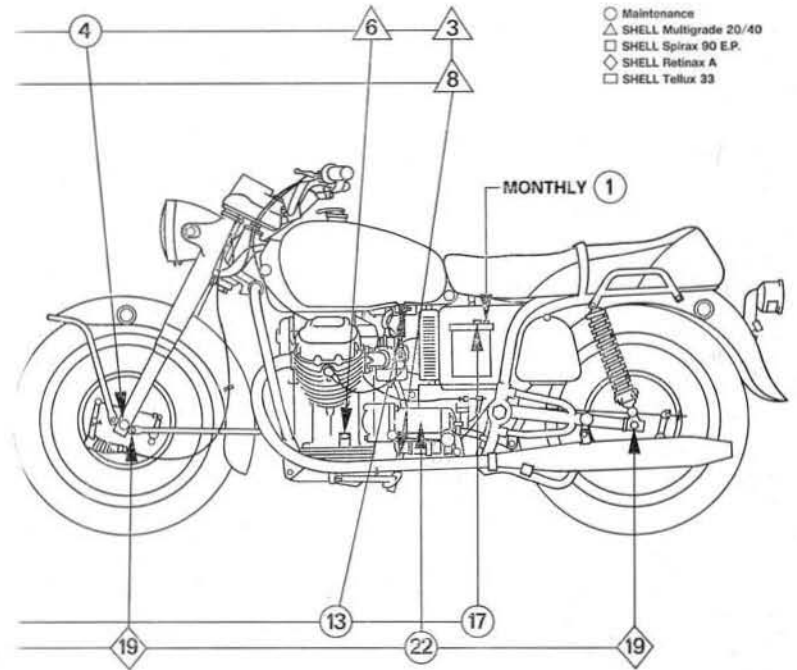
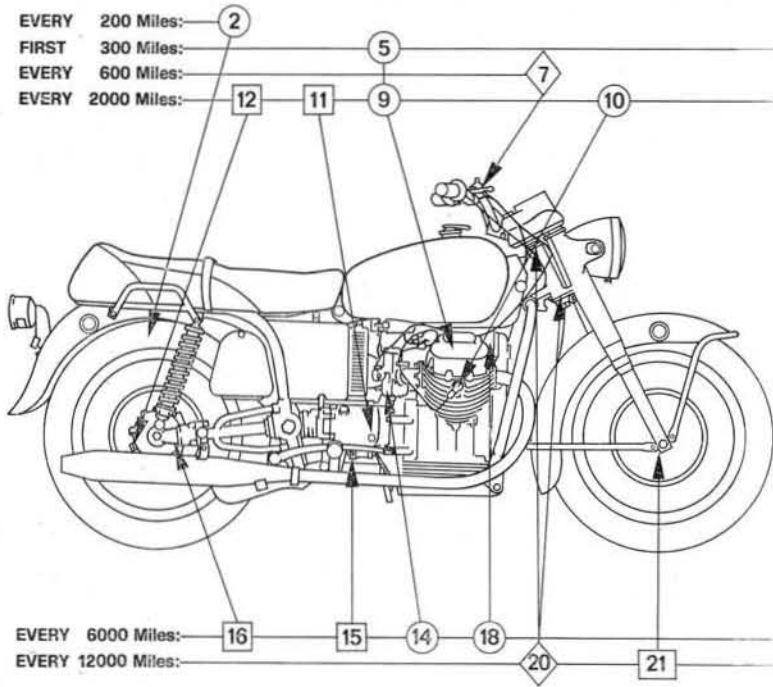

- Maintenance
- △ SHELL Multigrade 20/40
- SHELL Spirax 90 E.P.
- ◇ SHELL Retinax A
- SHELL Tellux 33

Fig. 8

be kept in neutral. Do not keep the clutch lever depressed, even during the briefest stops. Always change to a higher gear rather than let the engine race.

Stopping the machine

As soon as the machine stops, close the throttle, shift to neutral, turn the key to the « 0 » position and take it off (Fig. 6/1).

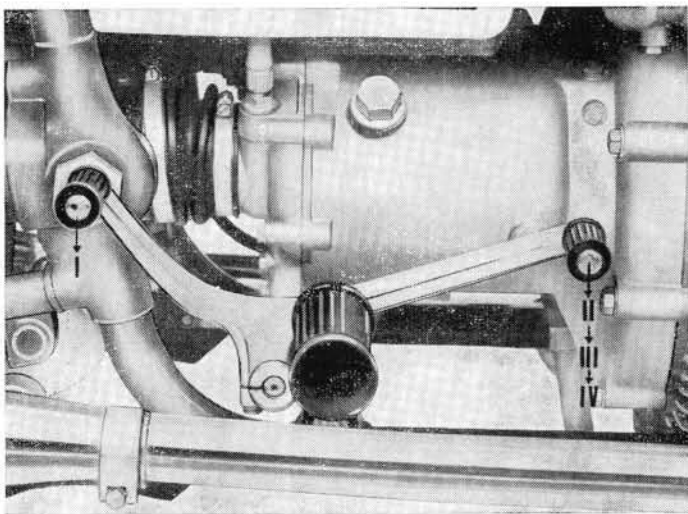

Fig. 9

LUBRICATION AND GENERAL MAINTENANCE CHART

(See fig. 8)

Monthly

- 1) Check electrolyte level in battery (every 15 days in summer) See « Battery ».

Periodically

- 2) Check tire pressure with a gauge.

After the first 300 miles

- 3) Replace the crankcase oil. See « Engine lubrication ».
- 4) Tighten all nuts and bolts.
- 5) Check and adjust tappet play, if necessary. See « Tappet adjustment ».
- 6) Check and if necessary top up oil level in crankcase. Correct oil level is in between the minimum and maximum marks on the dipstick. (See « Engine lubrication »).

Every 600 miles

- 7) Lubricate cable ends. See « Lubrication of clutch, front brake and air cables ».

Every 1800 miles

- 8) Replace oil in crankcase. See « Engine lubrication ».
- 9) Check tappet clearance. See « Tappet clearance ».
- 10) Check and clean spark plugs. See « Spark plugs ».
- 11) Check oil level in gear box and if necessary top up. See « Lubrication of gear box ».
- 12) Check oil level in transmission box for lubricating bevel gears. If necessary, top up.

Every 6000 miles

- 13) Clean petrol taps and filters, carburetor filters, and fuel line to carburetors. See « Carburation ».
- 14) Strip carburetor and check all parts. Use an air jet to clean out all ducts. See « Carburation ».

**After the first
12000 miles**

- 15) Change gear box oil. See « Lubrication of transmission ».
- 16) Change rear drive box oil. See « Lubrication of rear drive box ».
- 17) Check cleanliness and tightness of all battery connections and smear them with vaseline. See « Battery ».
- 18) Clean commutator of generator using a clean cloth slightly moistened in petrol. See « Generator ».
- 19) Check condition of wheel bearings and if still efficient pack them with grease. See « Lubrication of wheel bearings ».
- 20) Check condition of steering bearings and if still good pack with grease.
- 21) Replace oil in inner tubes. See « Lubrication of fork ».
- 22) Clean starter motor commutator using a clean rag slightly moistened with petrol.

SERVICING INSTRUCTIONS

**Lubrication
of engine**

(See fig. 10)

Using the oil filler dipstick (A), check the sump level every 500 kms. (300 miles).

Correct oil level is in between the minimum and maximum marks. Make this check on a warm engine with the filler cap screwed on one turn.

Every 3000 kms. (1800 miles) change the engine oil (on a new or overhauled machine this change should be made after the first 500 kms. (300 miles). The oil should be replaced when the engine is warm by unscrew-

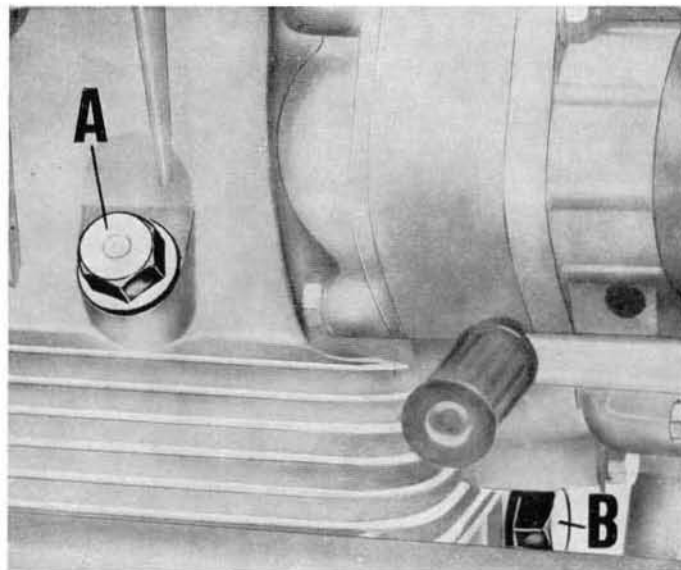

Fig. 10

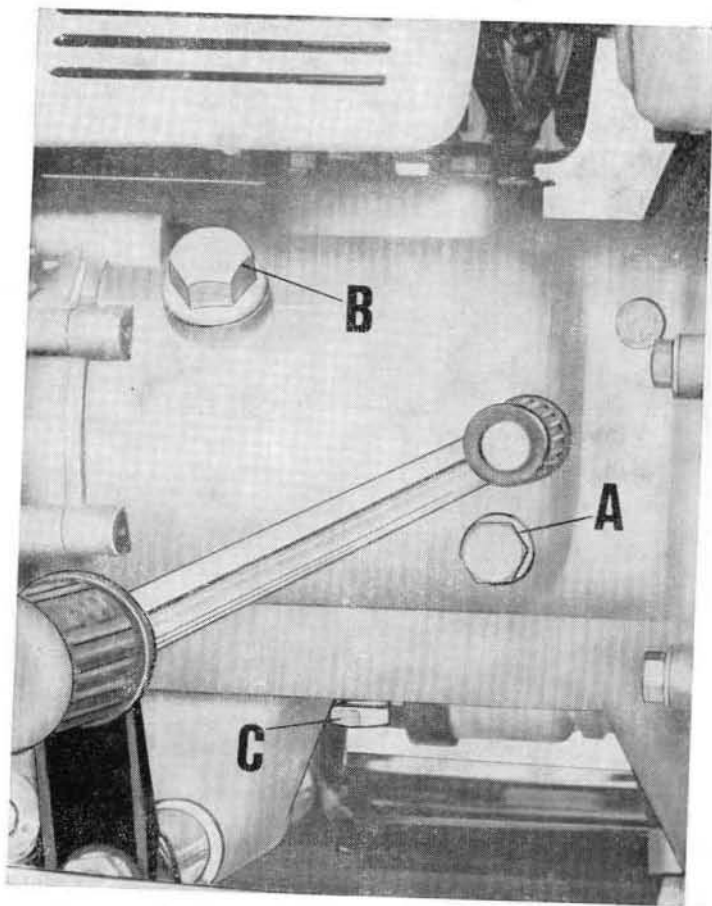

Fig. 9 bis

ing filler cap (A) and drain plug (B). Allow all the old oil to drain, re-fit plug B, and introduce fresh oil. Quantity required: about 3 liters (3 $\frac{3}{4}$ quarts). Oil recommendation: Shell Super Motor Oil 100.

Oil pressure relief valve

Under no circumstances should this valve be tampered with as it has already been calibrated at the factory for a pressure operation of 3.8 - 4.2 kgs/sq.cm. (54 - 60 lbs. sq.in.).

Oil pressure gauge

The indicator light goes out when the pressure is sufficient to open the contact of the pressure operated solenoid.

If this light stays lit, then the oil pressure is incorrect. In such cases, stop the engine and inspect all passages and oil lines to determine the cause and correct if before re-starting.

Lubrication of transmission
(See fig. 9 bis)

The oil in this box must be checked every 3000 kms. (1800 miles). The level is correct when the oil is flush with the plug hole (A). Change this oil every 10.000 kms. (6000 miles). This operation should be carried out a short time after a ride when the oil is warm and easily drained.

To change the oil proceed as follows: unscrew filler cap B, level plug A and drain plug C under the box. When the old oil has drained and plug C re-fitted, introduce fresh oil through B until it starts to leak out from level hole A, when both plugs can be put back.

Oil quantity required: abt. 0.750 liters (1 $\frac{3}{4}$ pints).

Oil recommendation: Shell Spirax 90 E.P.

Lubrication of rear wheel drive

(See fig. 11)

The oil level of this box should be checked every 3000 kms. (1800 miles).

The oil should just skim hole A. Change the oil every 10.000 kms. (6000 miles) and do this operation on a hot engine. Unscrew filler plug B, level plug A, and drain plug C. When the old oil has drained, refit plug C and introduce new oil until it starts seeping through hole A, finally screwing on plug A. Quantity required: about 0.230 liters ($\frac{1}{2}$ pint).

Oil recommendation: Shell Spirax 90 E.P.

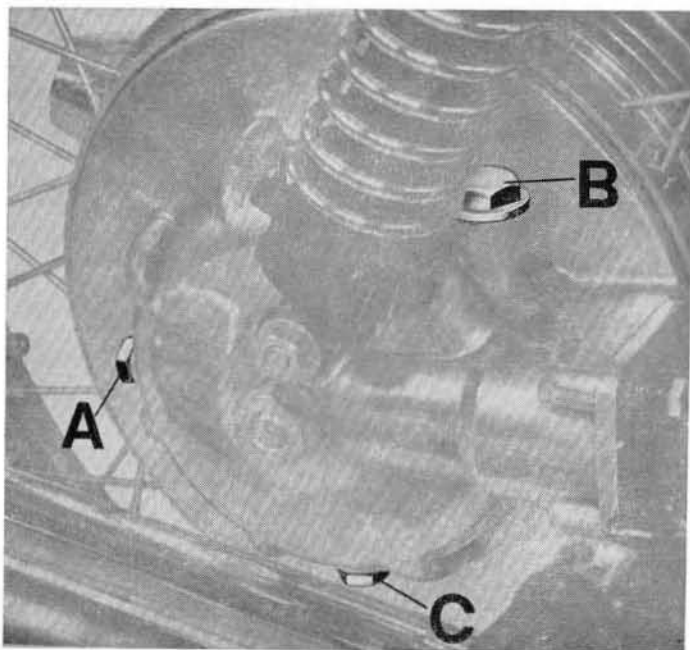

Fig. 11

Lubrication of front fork and hydraulic dampers

(See fig. 12)

Every 20.000 kms. (12.000 miles) or earlier, if necessary, change the oil in the fork tubes. Proceed as follows: remove the drain plugs and washer (A) and plugs (B). When the oil has drained, and drain plug A screwed on, introduce fresh oil through B.

Quantity of oil required for each fork tube: about 0.160 liters (5,4 oz.). Oil recommendation: Shell Tellux 33.

Lubrication of bevels in the steering

Every 20.000 kms. (12.000 miles) check condition of these bearings and pack them with Shell Retinax A grease.

Lubrication of wheel bearings

Every 20.000 kms. (12.000 miles) check the condition of these bearings and pack with Shell Retinax A grease.

Lubrication of control cables

Every 1000 kms. (600 miles) clean the cable ends and lubricate with Shell Retinax A grease. Actuate the levers several times to allow some of the grease to enter into the casings.

Lubrication of rear fork bearings

At the time of a general overhaul it is well to inspect these bearings to ensure that they are still efficient and, if necessary, pack them with grease. Recommended lubricant: Shell Retinax A.

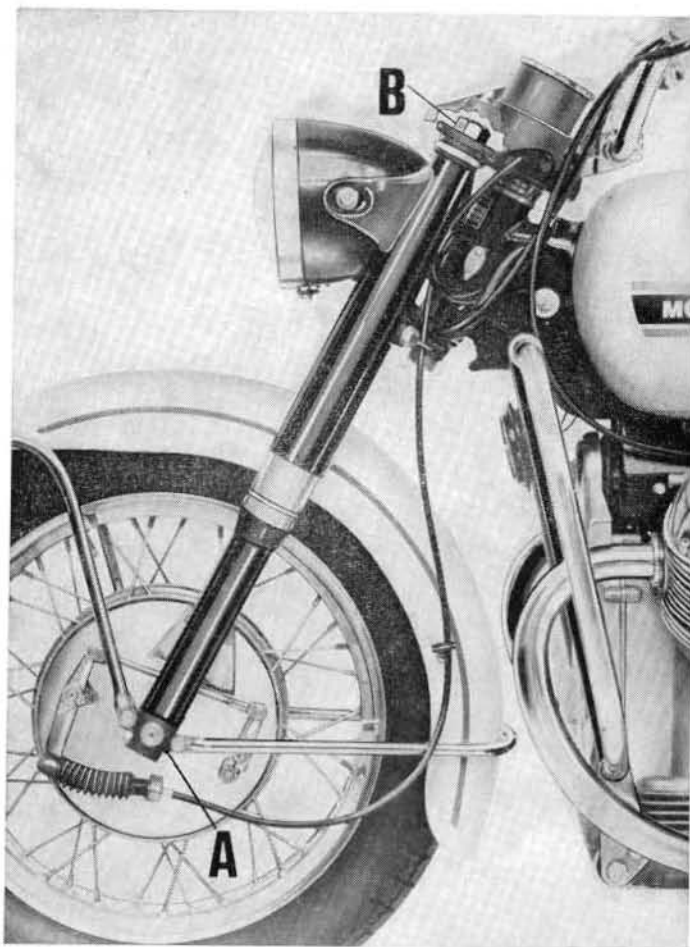

Fig. 12

CARBURATION

Filter and fuel lines

Every 10.000 kms. (6000 miles) or any time when fuel flow is irregular, the fuel lines, taps, 4-way adapter, and the carburetor connections as well as the filters in the taps and in the carburetors should be inspected and cleaned.

The filters are best cleaned in a petrol bath and dried off with compressed air. Ensure that the lines have not hardened too much at their connecting ends. If too hard, they should be replaced with original equipment.

Carburetor

This model is fitted with 2 dual control Dell'Orto carburetors type VHB 29 CD on the right and VHB 29 CS on the left.

Both controls are on the right handlebar: one is the air lever for easy starting, and the other is the throttle twist grip control. Every 10.000 kms. (6000 miles) the carburetor bowl should be cleaned out thoroughly and all carburetor ducts blown through with compressed air. Air should also be used to clean the jets as the use of wires or needles may alter the size of the jet and so upset carburation.

Standard carburetor setting

Choke	: 29 mm.
Throttle slide	: 60
Atomizer	: 265
Main jet	: 145
Pilot jet	: 45
Needle	: SV5 second notch from top
Air control atomizer	: 80

Adjusting the carburation

This adjustment must be made on a warm engine with the inlet and exhaust tappets at correct distance.

Proceed as follows:

- 1) Ensure that the air control in its fully closed position has about 4 mm. (.16") end play. If the cable is too stretched, engine vibration may cause the valves to open and a resulting irregular carburation.
- 2) Check synchronization of both gas valves with the filter box and the inlet sleeve disconnected. Turn the throttle grip keeping at the same time your fingers on the carburetor slides to feel if both valves open by the same amount and simultaneously. Should one valve open before the other, this can be corrected by setting screw A fig. 13 in the position where by turning the throttle both valves open simultaneously.
- 3) Adjust the idling speed by acting on screw C in fig. 13. Screwing this in reduces the fuel flow and viceversa increases it. To adjust, tighten and then turn screw out $1\frac{1}{2}$ turns for the L/H carburetor and $1\frac{3}{4}$ to 2 turns for the R/H carburetor.

With the engine running at about 1000-1200 r.p.m., disconnect one of the leads and turn screw C (fig. 13) of the opposite carburetor in or out to the position which will give the best idling speed i.e. when the revs are slightly increasing.

The same operation should be repeated on the opposite carburetor. This will give correct idling speed and prevent popping and spit backs.

Engine revolutions: Due to the characteristics of this engine, the idling adjustment should never be made with the engine running at less than 800-900 r.p.m.

A good idling speed is obtained as follows:

- 4) Disconnect the R/H cylinder plug lead and after starting the engine, ensure that the engine stops after firing 4 or 5 times. If it

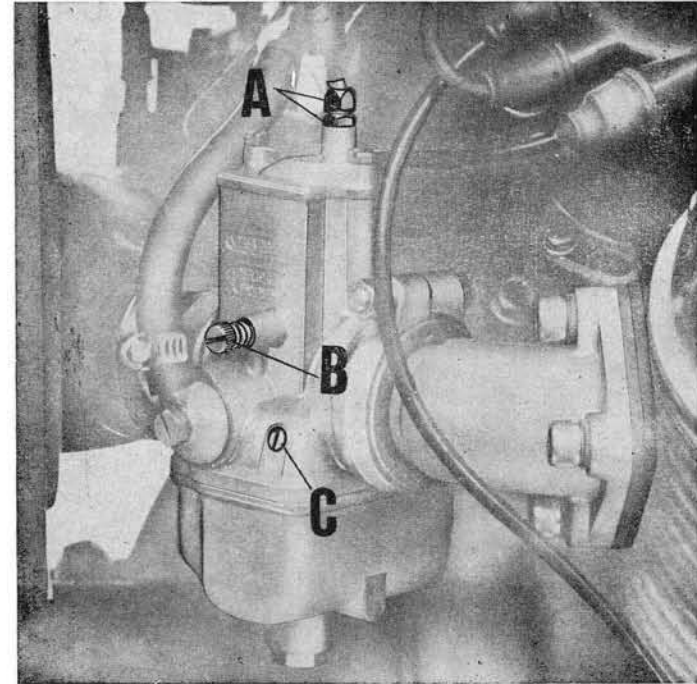

Fig. 13

dies out sooner or later, it is necessary to adjust idling screw B fig. 13 setting it at the point where the engine will stop after it has fired 4 or 5 times.

The same operation should be repeated on the right hand cylinder, with the left hand plug lead disconnected. If the R/H cylinder is normal, the engine should stop after firing 4-5 times. If not, screw B fig. 13 should be adjusted to the position where it does so. Finally, the left cylinder plug lead should be re-connected.

Stripping of carburetor

(See fig. 14)

Remove:

- Mixture chamber cover (1) complete with cable adjusting nut and spring (2), after loosening screws (3).
- Throttle slide (4) with taper needle (5).
- Throttle slide stop screw and spring (6).
- Plug and washer (7).
- Bowl (8).
- Pilot jet (9).
- Accelerator pump (10) with main jet (11) and atomizer (13).
- Atomizer (13).
- Float (14) with securing pin (15).
- Needle (16).
- Pilot air screw (17) with spring.
- Adaptor screw (18) with washer.
- Adaptor (19).
- Adaptor filter (20).
- Air control plug (21) with screw and nut.
- Plug securing screw (22).
- Spring (23) with air control plug (24).

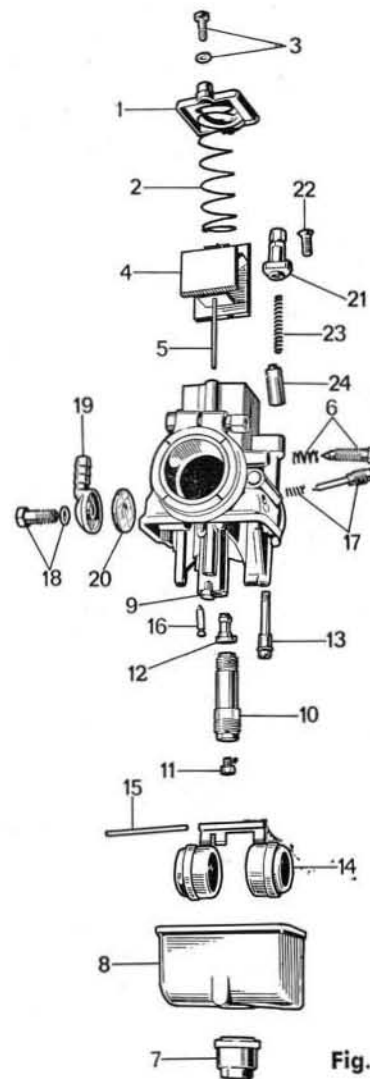

Fig. 14

After the carburetor has been stripped and all parts cleaned with an air jet, it is a good practice to inspect and clean the fuel filters and line from the tank.

Air filter

(See fig. 15)

The dry type filter is located in a suitable box secured to the frame. Air to the carburetor is taken directly through a rubber sleeve from the air filter box. When the filter is too dirty, replace it with original equipment.

Fuel tank

(See fig. 16)

When stripping the carburetors, the fuel tank, tap filters, tap ducts (A), adaptor filters (B), fuel lines (C), and the four-way adaptor should also be thoroughly cleaned. The tank is best cleaned when removed from the tank, pouring some petrol in it and shaking vigorously. Drain from the top opening to carry away any sludge or scaling which may have deposited at the bottom of the tank. The filters are best cleaned with petrol and compressed air.

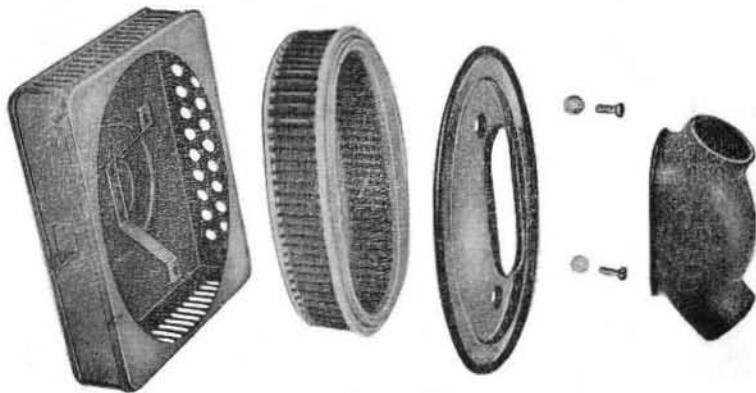

Fig. 15

Fuel taps

(See fig. 16/1)

Are located under the fuel tank. When turned downwards (A) the taps are open, and vice-versa when in the horizontal position (B). It is suggested to ride with only one tap open and to use the other as a reserve to be opened in an emergency.

It is a good practice to occasionally check if the fuel reserve tap is still efficient. Clean, if it is obstructed.

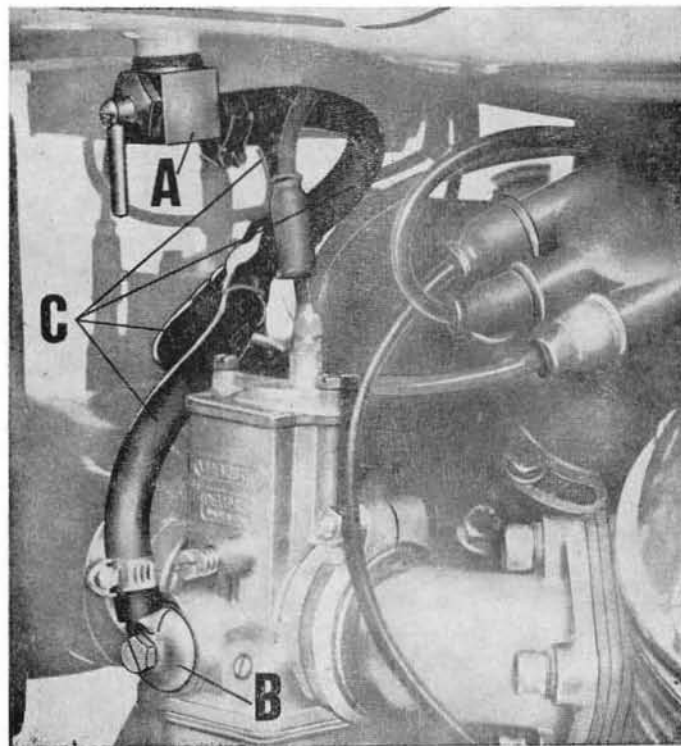

Fig. 16

Mufflers

Internal cleaning of the mufflers is carried out as follows: fill the mufflers with a solution of boiling water and caustic soda (20%) and allow them to stand for about an hour when they can be emptied and rinsed out with boiling water while shaking vigorously.

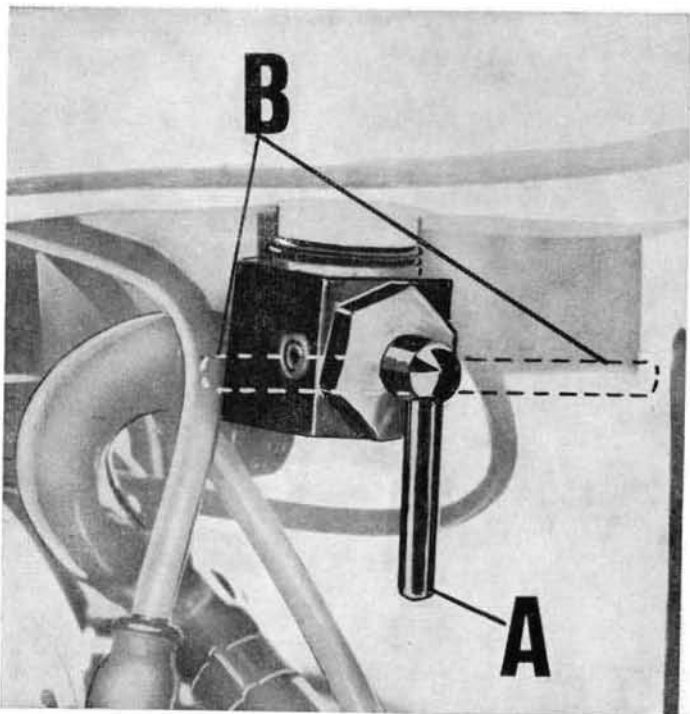

Fig. 16/1

VALVE GEARING

Tappet clearance (See fig. 17)

Every 3000 kms. (1800 miles) or any time valve operation is too noisy, check tappet clearance.

This adjustment is made on a cold engine with the piston at TDC and both valves closed while the piston is on its compression stroke. Using the wrench supplied in the tool kit, undo nut A and screw in or out screw B.

Correct clearance is:

- Inlet valve 0.15 mm. (.0059")
- Exhaust valve 0.25 mm. (.0098")

Use a feeler gauge (C) to check this clearance. When this is excessive, there will be noisy valve operation.

If it is less, the valves may not close fully causing compression loss, overheating of the engine, etc.

On a new engine, this adjustment must be made after the first 500 kms. (300 miles).

Checking valve timing

The engine is timed when the gears are set as shown at A and B in fig. 18. A proper check of valve timing is always done better in any officially appointed Moto Guzzi dealer shop.

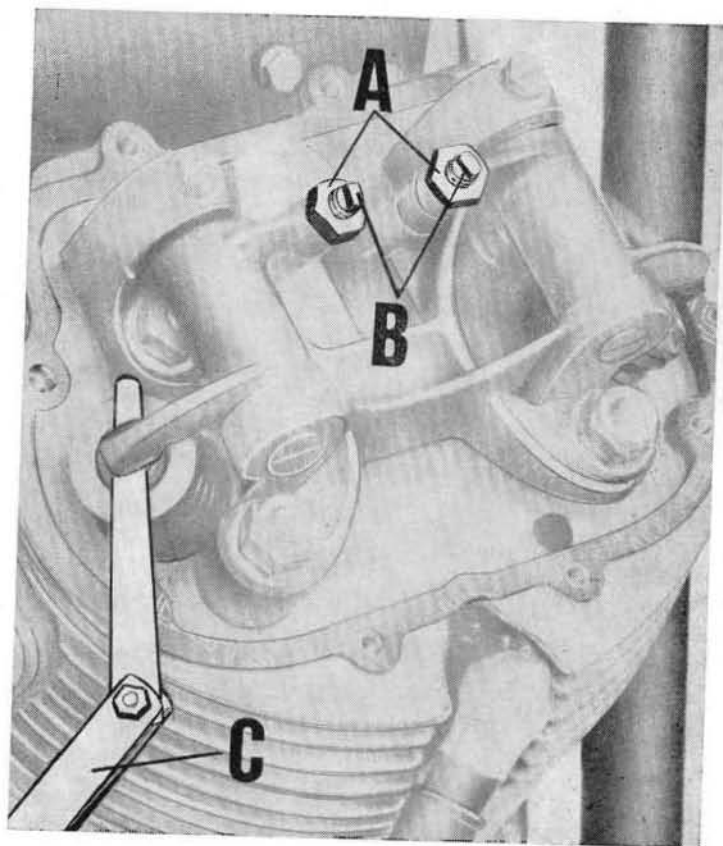

Fig. 17

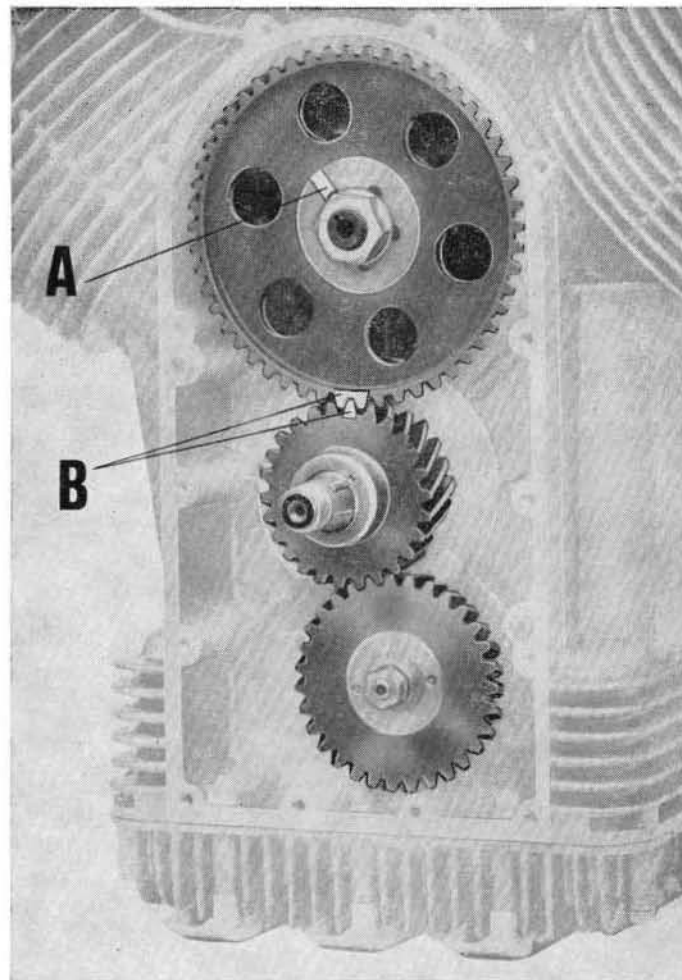

Fig. 18

IGNITION

Distributor

(See fig. 19)

Every 3000 kms. (about 1800 miles) the cam felt pad should be lubricated with a few drops of oil and the contact points inspected to ensure they are clean. If dirty or greasy, clean them with a petrol soaked cloth. Correct gap is 0.42-0.48 mm. (.016-.018"). If they need adjusting, loosen screw B which secures the fixed contact plate and move this to the position which will give the correct gap. However, the contact points should be changed whenever it is necessary.

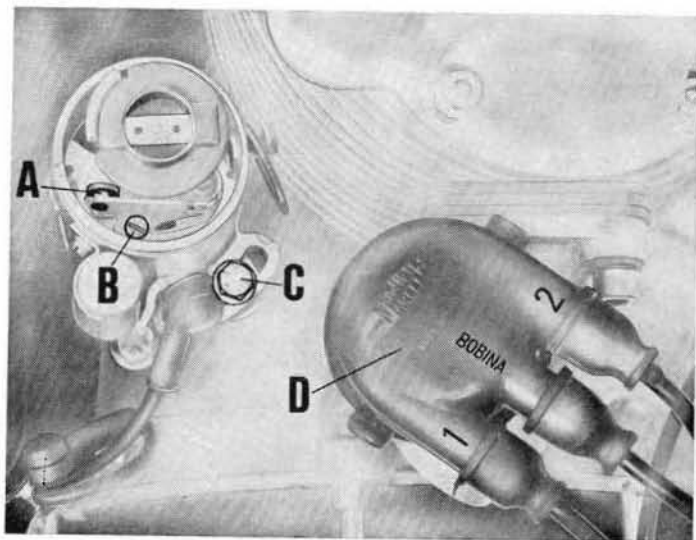

Fig. 19

Spark plugs

Every 3000 kms. (1800 miles) check the gap which should be 0.6 mm. (.023"). Check also the high tension leads and replace, if necessary. The spark plugs are best cleaned with petrol, a wire brush, and a needle for the inner part.

In fitting the plugs, make sure they are started by hand for a few turns and to complete the operation by means of the plug wrench in the tool kit. Do not overtighten to prevent stripping of the thread.

Checking of ignition timing

Remove generator belt cover. Check that the distributor contact points are 0.42-0.48 mm. (.016-.018") apart. Ensure the left cylinder (2) is on its compression stroke i.e. with both valves closed. Rotate the generator pulley on the crankshaft till the slot (fig. 19/1) is opposite mark A traced on the timing cover.

In this position the points should start to open and to ensure that they do so use a timing light which will light up at the exact time the points start opening.

If the points start to open before or after the mentioned point, slacken distributor securing bolt C (fig. 19) and turn the distributor to the right or left to the position where the points start opening at the proper time.

The cylinder number is marked on the distributor cap as follows: n. 1 (right cylinder), n. 2 (left cylinder), « bobina » = coil (see D in fig. 19).

Checking of ignition advance (fixed and automatic) by means of a stroboscope lamp

For checking the ignition advance, the crankshaft driven generator pulley of the V-7 engines has been provided now with 3 additional timing marks. When in coincidence with arrow « A » already stamped on the timing cover, these marks will serve to determine if the ignition is correctly timed.

The new reference marks on the pulley (See fig. 19/1 and diagram 19/2) can be defined as follows:

- « B » (first on the left) is the TDC position mark for the 2nd cylinder (on the left, as seen astride the saddle).
- « C » is the 10° fixed advance position to the TDC.
- « D » is the 30° automatic advance position to the TDC.
- « E » is the 38° maximum advance position (fixed + automatic) to the TDC.

With the engine assembled on the machine, this control is made as follows:

- Remove generator belt cover by unscrewing its 3 retaining bolts.
- Connect the timing device cable to the plug of cylinder 2 (left sitting in the saddle).
- Connect the 2 stroboscope cables with clamps to a battery, ensuring that clamp (+) is secured to battery pole (+) and the other to pole (—).

After these connections to the plug and battery have been made, start the engine and direct the stroboscope light on to arrow « A » on the timing cover.

Check that this arrow coincides with the generator pulley marks « C-D-E » at the following engine speeds:

- Mark « C » at 1200 ± 100 r.p.m.
- Mark « D » at 2200 ± 100 r.p.m.
- Mark « E » at 3600 ± 100 r.p.m.

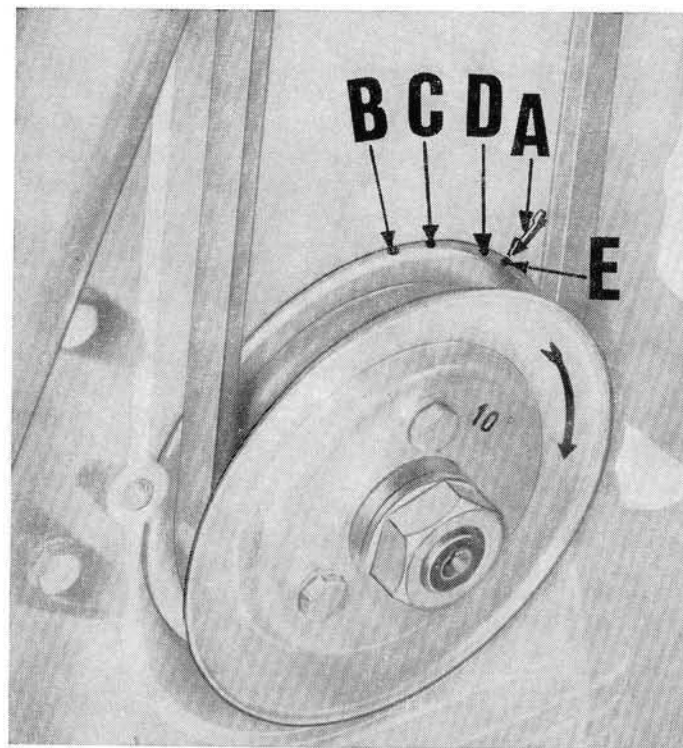

Fig. 19/1

If this check shows that arrow «A» is in coincidence with pulley marks «C-D-E» at the above engine speeds, then the fixed and automatic advance are quite normal.

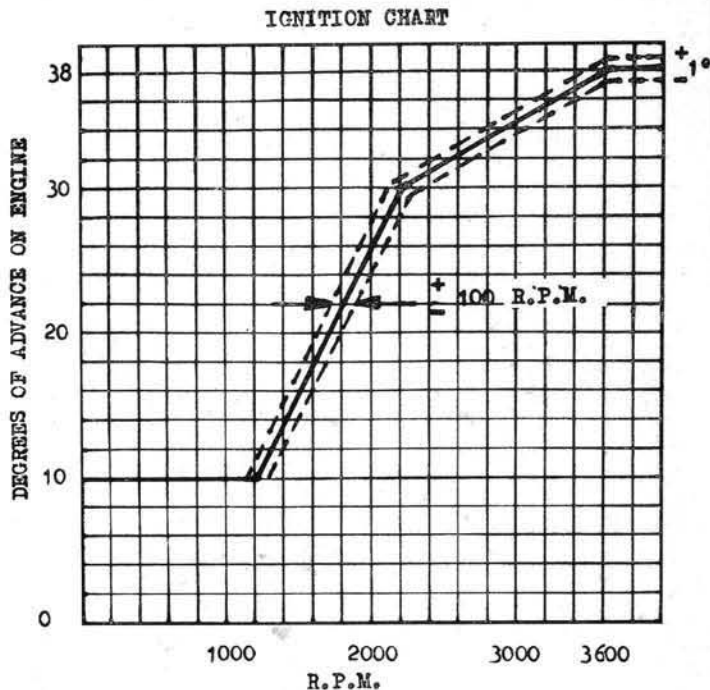

Fig. 19/2

ADJUSTMENTS

Generator belt (See fig. 20)

After long service the belt may slacken and in such case it should be tensioned. Normal belt slack A is 1 cm. per 10 kgs. (.039"/21 lbs.). The belt is tightened as follows:

- Unscrew bolts B which secure the outer half-pulley to the hub,
- remove the external half pulley,
- remove one or more spacing collars to reduce the width of the race,
- if it is necessary to remove more than one spacer, they should be placed at the front and rear of the pulley.

Finally, re-fit the outer half-pulley, tightening its 3 securing bolts (B).

Clutch lever (See fig. 21)

This lever should be adjusted when the free play at the handlebar is more or less than 4 mm. (1/8"). Slacken thumb screw B and screw in or out adjuster A to obtain the correct distance. Don't forget to re-lock thumb screw B.

If the distance is less, the clutch may slip causing the plates to wear out. If it is more, there may be incomplete disengagement of the clutch and consequent noisy gearshifting. This adjustment can also be carried out by slackening nut D and acting on adjuster C bolted on the battery bracket.

Steering (See fig. 22)

Looseness of the steering is remedied as follows:

Slacken locknut A and using a suitable wrench, adjust locking B to the position which will take up excessive play and then re-lock nut A by keeping a hold on locking

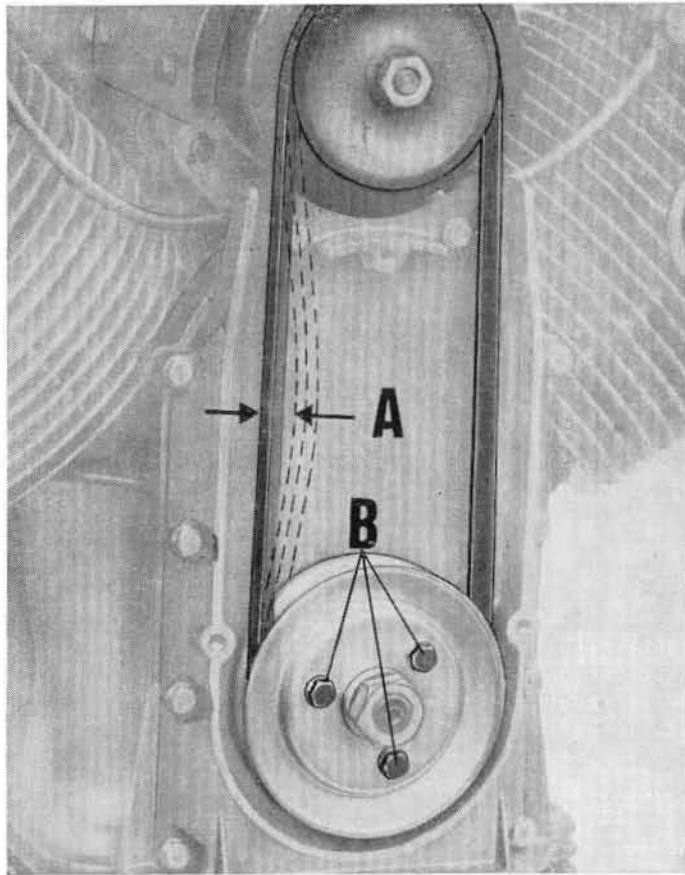

Fig. 20

B. Do not forget that loose steering may cause wear of the taper bearings.

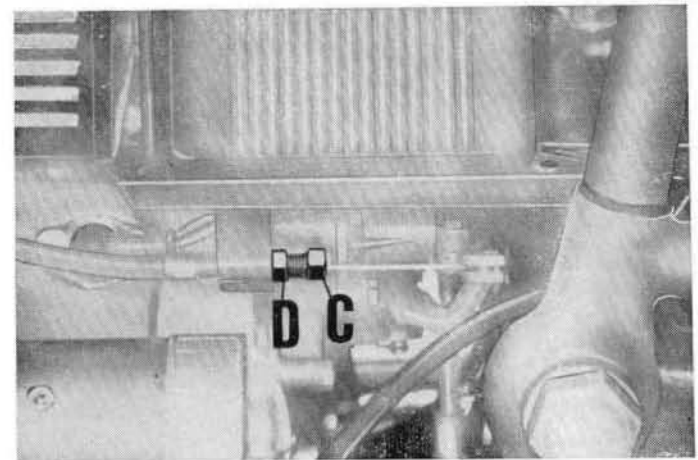
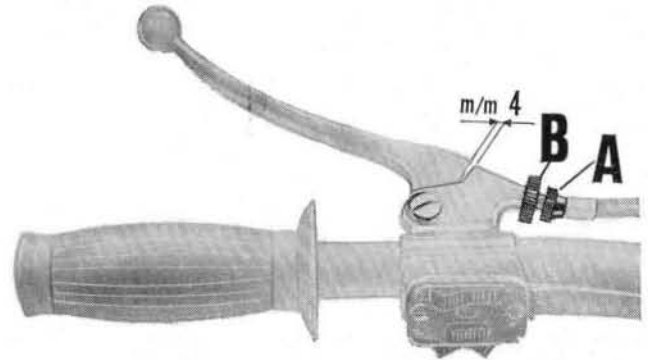

Fig. 21

Steering lock

(See fig. 22/1)

It is located on the L/H side of the steering column (See A) and it is key operated.

To lock: turn the handlebar completely to the right and insert the key turning it forward (toward the front wheel). Push it in, release it and pull it out.

To open: Insert key in the lock, turn it forward and release it.

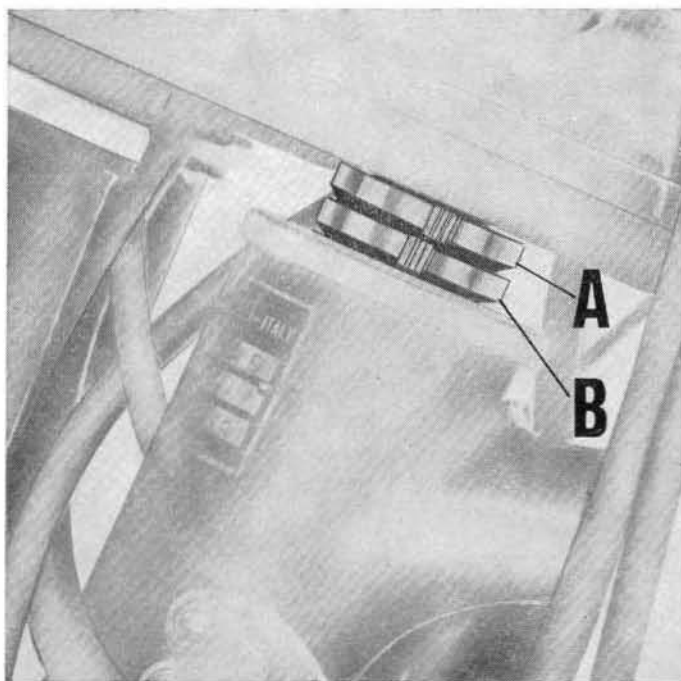

Fig. 22

Front brake lever

(See fig. 23)

Play at the handlebar lever should be checked periodically. The lever is adjusted when there is about 20-25 mm. (3/4 to 1") play at the handlebar before the linings contact the drums.

Excessive play is corrected by acting on thumb screw B and adjuster A or on adjuster C and nut D on the hub cover.

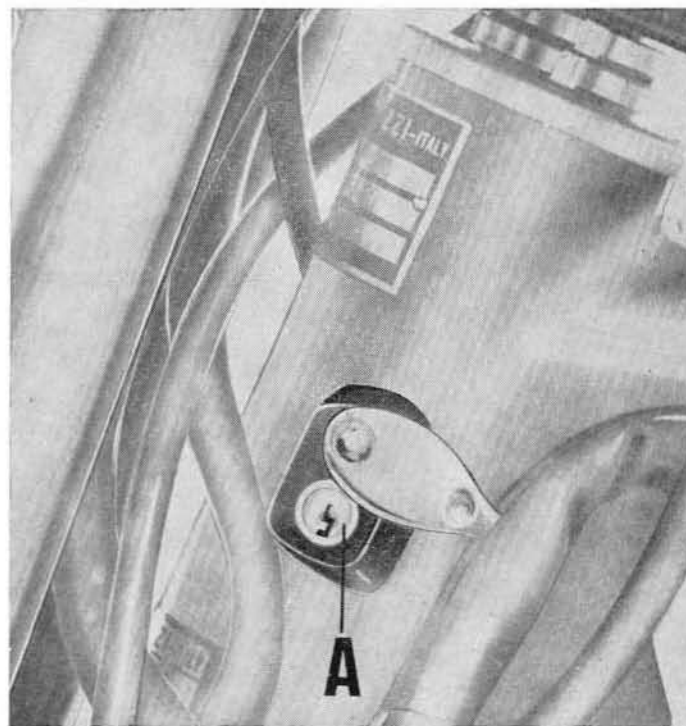

Fig. 22/1

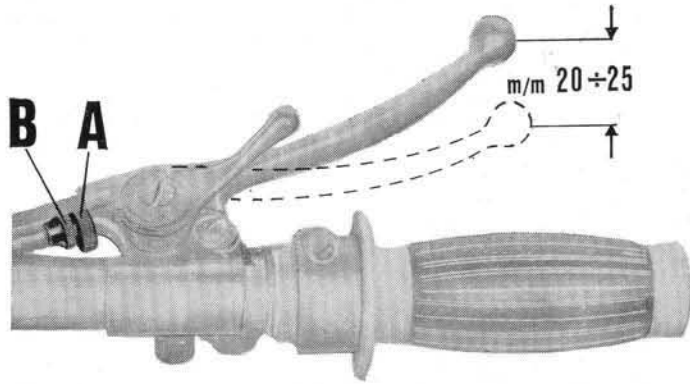
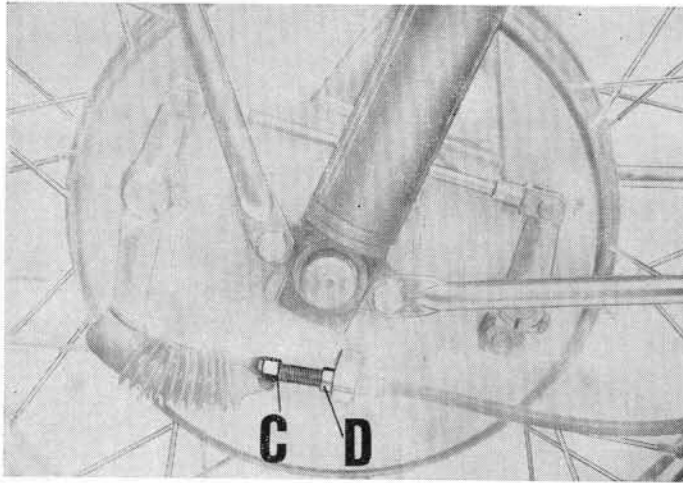

Fig. 23



Rear brake pedal
(See fig. 24)

Adjustment of this lever is made by means of the thumb screw fitted on the threaded portion of the brake rod.

Excessive play is corrected by screwing in thumb screw A on the rod until there is a play of about 20-25 mm. (3/4 to 1") at pedal B before the linings contact the drums. Generally, when the screw is fully screwed on it means that the lining is completely worn out and has to be changed.

Rear suspension units
(See fig. 25)

The rear suspension unit has a 3-position adjustment: I for normal load, II medium load, III heavy load.

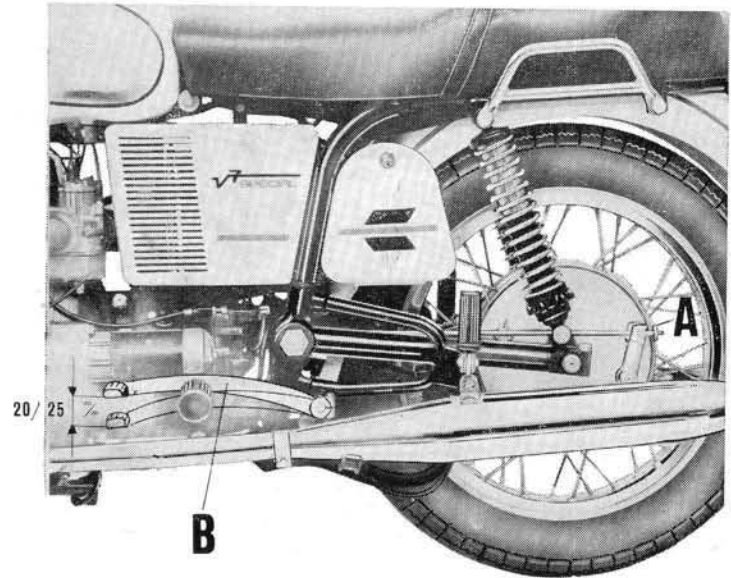

Fig. 24

Change over to any required position is made by turning knob B using the special wrench (A) in the tool kit. This knob is turned anticlockwise until « II » or « III » coincides with reference C.

In case of faulty damper operation it is recommended to have them checked by your dealer or in a shop officially appointed by the makers.

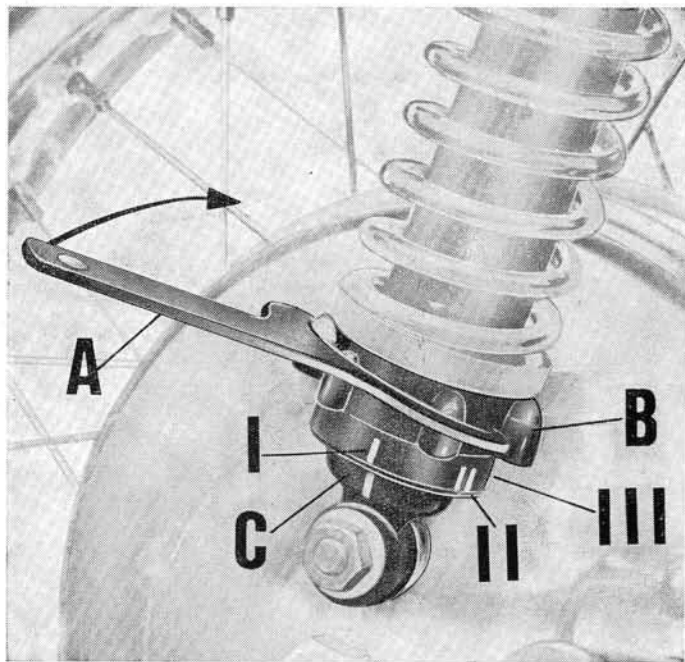

Fig. 25

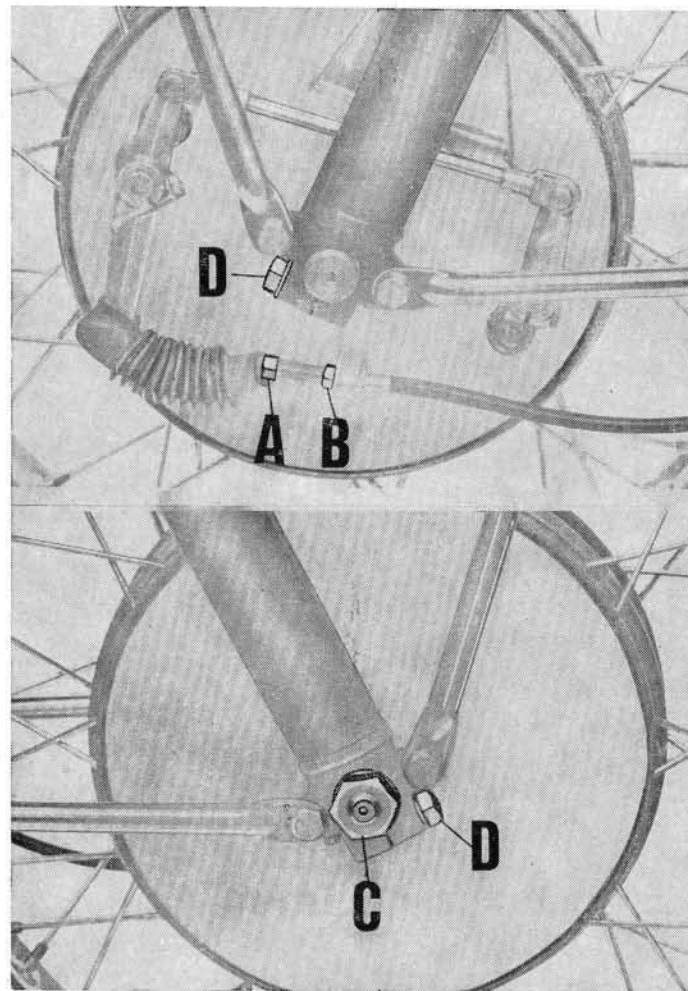

Fig. 26

REMOVAL OF WHEELS

Front wheel (See fig. 26)

To remove the front wheel disconnect the front brake cable from the operating lever on hub cover A and unscrew cable adjuster B. Undo nut « C » which secures the wheel spindle to the right fork member and bolt B which secures the left hand member, taking out the wheel spindle. Now push the wheel down just sufficiently to free the brake block from its anchoring lug on the left fork member and back it out.

N.B. - When re-assembling dont forget to insert the brake block in its anchorage on the left fork member.

Rear wheel (See fig. 27)

Unscrew nut A which secures the wheel spindle to the rear drive box and the nut which secures the stay to the brake block. Undo the rear brake adjusting thumb screw (B) and bolt C which locks the spindle to the rear fork and withdraw the spindle.

Pushing the wheel to the left will free the wheel from the sleeve in the drive box thus allowing the wheel to be removed by leaning the machine sideways.

N.B. - When re-assembling dont forget to secure the anchoring brace to the brake block.

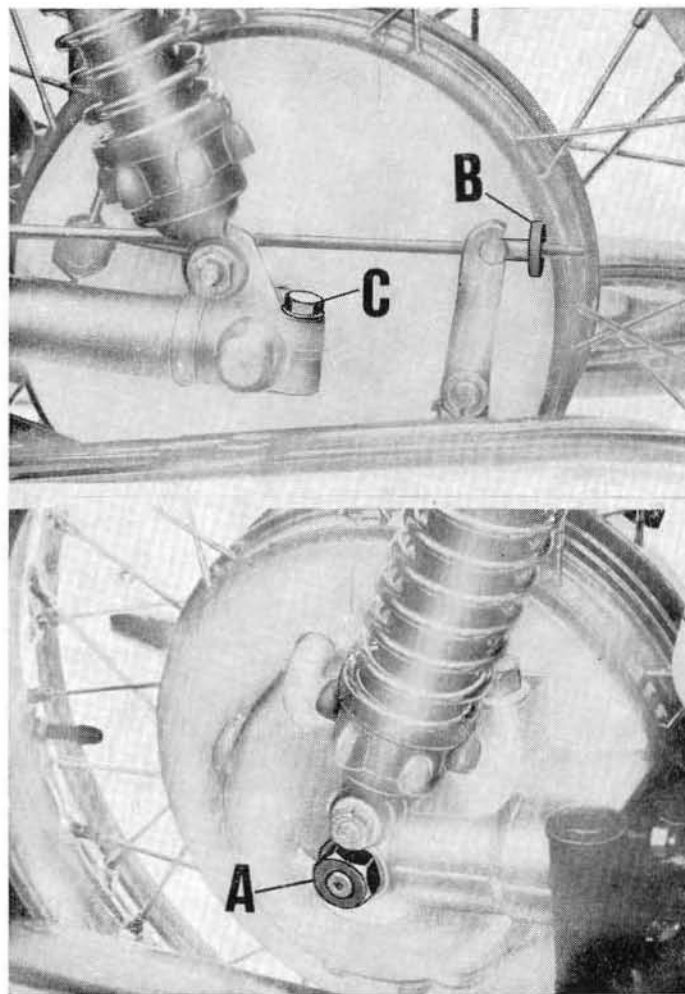

Fig. 27

ELECTRICAL EQUIPMENT

(See diagram fig. 28)

Battery

The 12 V battery is centrally mounted and has a capacity of 32 Ah. It is charged directly by the generator.

Every 3000 kms. (1800 miles) check the electrolyte level in each cell and if necessary top up with distilled water, using a glass or plastic funnel. The level is correct when the acid tops the plate separator by about 6 mm. (1/4") Always top up with distilled water and not with sulphuric acid.

Add distilled water to a cold battery and after it has not been in use for at least 6 hours.

Make sure that no electrolyte flows over the top of the battery which must always be in a perfectly dry condition. If the level in any one cell is lower than in others, this may be due to either cracks or other faults and in such case the battery should be immediately replaced.

Every 6000 miles check that all battery connections are in a perfectly clean condition and smear them with vaseline to prevent oxidation.

The battery is charged when the hydrometer reading shows about 1.28 sp.g. for normal service and about 1.23 sp.g. for service in tropical conditions. An almost discharged battery shows a reading of about 1.16 sp.g. for normal service and about 1.1 sp.g. for tropical conditions.

Putting the dry charged battery in service

1. Break off the seal and unscrew the plug.
2. Introduce pure sulphuric acid of 1275 sp.g. - temperature 15° (31° Baumé).

This operation has to be carried out very carefully and particular attention should be paid to the specific gravity of the recommended liquid.

The correct electrolyte level is 6 mm. over the plate separators (.23").

3. Let the battery at rest for about 2 hours and then top up with electrolyte to the recommended level.

The battery can now be charged for 8-15 hours at a current intensity equal to 1/10 th of its normal amperage (in 10 hours discharge).

4. The battery is now ready to be put in service.

Maintenance instructions

During the period that the battery is left at rest before use, ensure the electrolyte level is about 6 mm. (.23") over the top of the plate separators. Ensure that this level is maintained at all times with the addition of distilled water. Never add sulphuric acid. If the battery is not used immediately, it is best to have it charged for a short period every month or every time before it is used.

Successive charges

Before re-charging make absolutely certain that the battery is in a perfectly clean condition.

Connect to the charging medium and use preferably an amperage equal to but not

exceeding 1/10th of the rated battery capacity over a period of 10 hours.

If during the charge the electrolyte temperature (measured with a thermometer immersed in the electrolyte) should get up to 50°C (122°F), it will be necessary to reduce or interrupt the charge until the temperature has dropped to under 40°C (104°F).

Never add sulphuric acid but top up only with chemically pure distilled water.

Generator

Every 10.000 kms. (6000 miles), the commutator should be cleaned with a clean cloth slightly moistened in petrol.

Copper or carbon dust which may have deposited in between the rotor blades can be removed by compressed air.

When cleaning the commutator check also the condition of the brushes and if chipped or worn, replace them ensuring that they make good contact and are flush with the commutator, or else this may get damaged.

N.B. - Replacement of brushes must be made with original parts and preferably by fully qualified electricians.

Regulator unit

The regulator is sealed to prevent it from being tampered with. In case of failures or incorrect operation, it should be sent for inspection to the makers or their agents. Replacements must be made with original parts bearing the same number.

Starter motor

Clean its commutator every 20.000 kms or so (12.000 miles). To clean it use a petrol moistened cloth.

Carbon or copper dust between the rotor blades can easily be removed by compressed air. Check condition of the brushes and if any are worn or chipped, replace them. To avoid damage to the commutator, the brushes should be in perfect even contact with it. Use only original parts and have this job done preferably by qualified electricians.

Horn

The 12 V horn does not require any maintenance. In case of irregular operation have it seen to by competent electricians or replace it.

Light switch and horn button

Does not require any adjustment but in case of faulty operation, remove its cover and check all contacts, screwing down tightly all wires.

Headlight European version

The headlamp is perfectly watertight and this makes internal inspection practically unnecessary. The reflector should never be polished as it is extremely delicate and might easily lose its lustre.

In case of replacements, always use lamps of same size and specifications as originally fitted:

Headlamp:

- main bulb 45/40 W (round);
- pilot bulb 5 W (tubular).



Tail lamp:

- 5/20 W double filament lamp (round).

Instrument panel:

- panel illumination 3 W (round);
- pilot light indicator 3 W (round);
- ammeter 3 W;
- neutral indicator 3 W;
- oil pressure 3 W.

Headlight US version

Of sealed beam type.

Lamps

- Headlight: sealed beam insert 168 mm.
(6.6") 45/40 W
- Tail light: two filament, round 20/5 W
- Speedometer: round 3 W
- Dimmer indicator: round 3 W
- Ammeter: round 3 W
- Neutral indicator: round 3 W
- Oil pressure: round 3 W

Tail lamp

Of approved type on both US and European versions.

Fuses

4 fuses of 25 Amp. protect all the battery fed electrics i.e. ignition switch, speedometer, warning lights, stop light, and horn. If a fuse blows, trace and correct the cause, and replace with a similar fuse .



Cables

Check these over occasionally and ensure their perfect condition. Replace as necessary.

N.B. - If any extra accessories are added, ensure they are connected to the terminals which can stand the load and not going beyond the capacity of the terminal itself and/or the H.T. leads, thus preventing possible damage the the electric system.



KEY TO CABLE COLORS (See fig. 28)

EUROPEAN MODEL

1 - Black	: Battery (+) to starter motor
2 - Red	: Battery to regulator 51 B +
3 - Red	: Ignition switch 30/30 to battery +
4 - Grey-red	: Regulator to generator D +
5 - White	: Regulator DF to generator DF
6 - Black	: Headlight to stop cutout
7 - Yellow	: Headlight terminal to tail light
8 - Green	: Warning light F to neutral indicator cutout
9 - Brown	: Starter button to starter motor solenoid
10 - Blue-black	: Headlight terminal to H.T. coil
11 - Grey	: Warning light F to oil pressure cutout
12 - Red	: Warning light A to generator
13 - Black	: Distributing block to horn
14 - Red	: Ignition key 15/54 to headlight terminal
15 - White	: Speedometer AA to distributing block
16 - Yellow-black	: Warning light CC to distributing block
17 - Brown	: Ignition switch INT to headlight terminal
18 - White-black	: Warning light FF to headlight terminal
19 - Green	: Light switch to distributing block
20 - Green-black	: Light switch to distributing block
21 - Grey-red	: Light switch to distributing block
22 - Brown	: Light switch to headlight terminal
23 - Black	: Horn button to distributing block
24 - Black	: Horn T+ to headlight terminal
25 - Blue	: Parking light to distributing block
26 - Black	: Stop light cutout to tail bulb
27 - Black	: Regulator to ground
28 - Black	: Battery to ground
29 - Black	: H.T. coil to contact breaker
30 - Black	: H.T. coil to distributor
31 - Black	: Distributor to spark plug
32 - Black	: Distributor to spark plug
33 - Black	: Headlamp to ground
34 - Green	: Distributing block to low beam light
35 - Green-black	: Distributing block to high beam light
36 - Black	: Headlight bulb to ground
37 - Black	: Parking light to ground
38 - Blue-black	: Headlight terminal to button horn
39 - Blue-black	: H.T. coil + to rev-counter
40 - Black	: H.T. coil - to rev-counter 1
41 - Black	: Rev-counter BB to ground
42 - Black	: Starter motor to ground

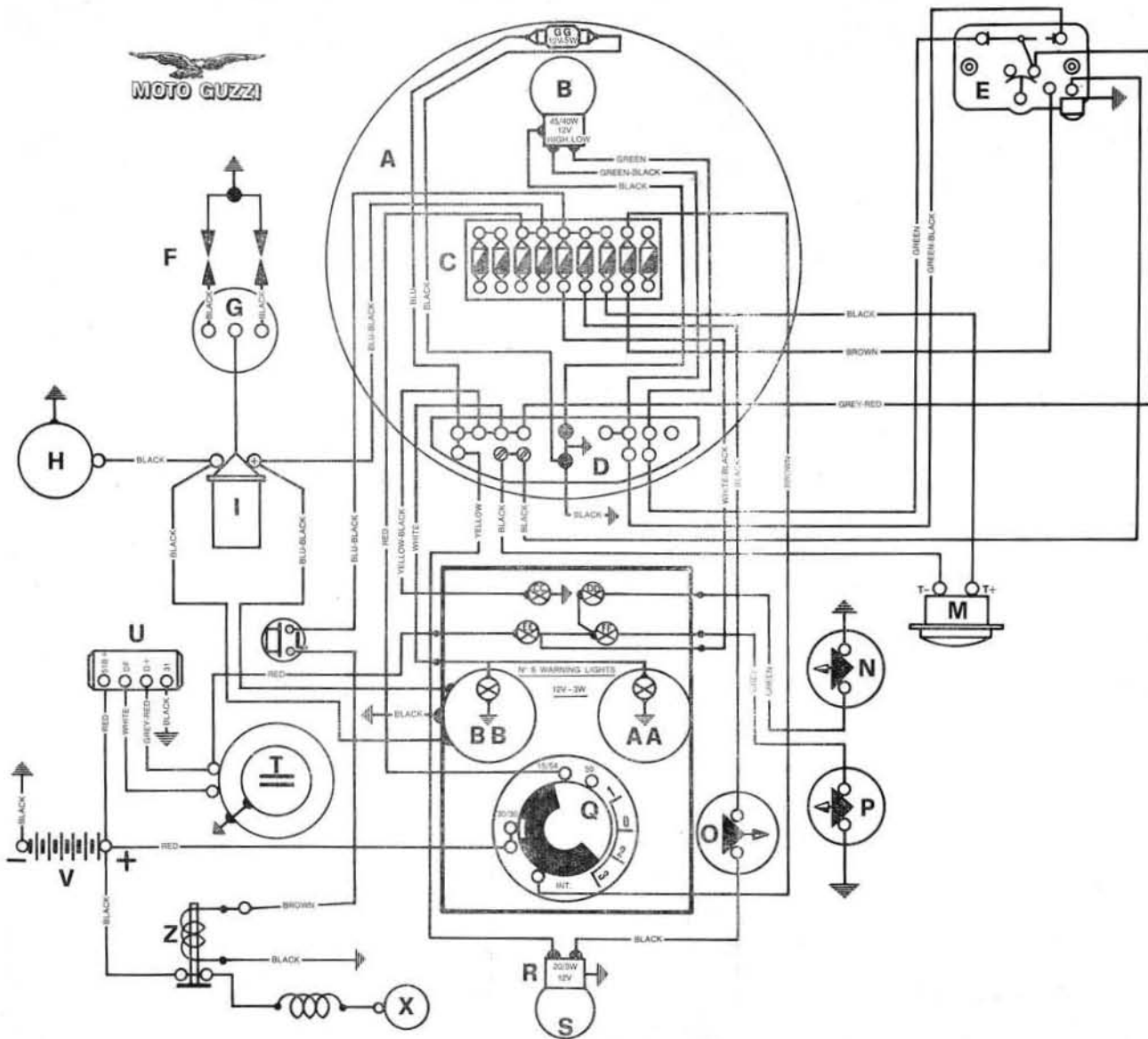

Legend:

- A HEADLIGHT
- B MAIN LIGHT BULB
- C TERMINAL BLOCK WITH FUSES
- D DISTRIBUTING BLOCK
- E LIGHT SWITCH AND HORN BUTTON
- F SPARK PLUG
- G DISTRIBUTOR
- H CONTACT BREAKER
- I H.T. COIL
- L STARTER BUTTON
- M HORN
- N NEUTRAL INDICATOR CUTOUT
- O STOP LIGHT
- P OIL PRESSURE CUTOUT
- Q IGNITION SWITCH
- R NUMBER PLATE AND TAIL LIGHT
- S PLATE ILLUMINATION
- T GENERATOR
- U REGULATOR
- V BATTERY
- Z STARTER MOTOR SOLENOID
- X STARTER MOTOR
- AA SPEEDOMETER WITH ILLUMINATION BULB
- BB REV-COUNTER
- CC LIGHTS INDICATOR (red)
- DD NEUTRAL INDICATOR (amber)
- EE CHARGE INDICATOR (red)
- FF OIL PRESSURE INDICATOR (red)
- GG PARKING LIGHT

IGNITION SWITCH POSITION

- = 0 =
- = 1 = 30/30 - INT.
- = 2 = 30/30 - INT, 15/54
- = 3 = 30/30 - INT, 15/54 - 50

NB.: Position = 3 = does not serve on machines with starter button.

Fig. 28



KEY TO CABLE COLORS (Fig. 29)

USA MODEL

1 - Black	: Battery V to starter motor solenoid Z
2 - Red	: Regulator U 51 B+ to battery V
3 - Red	: Battery V to ignition switch Q
4 - Grey-red	: Generator T to regulator U (D+)
5 - White	: Generator T to regulator U (DF)
6 - Black	: Terminal with fuses C to stop cutout O
7 - Yellow	: Distributing block D to tail light bulb R
8 - Green	: Neutral cutout N to warning light DD
9 - Brown	: Starter button L to starter solenoid Z
9/1 - Blue-black	: Terminal block C to starter button L
10 - Blue-black	: Terminal block C to H.T. coil I
10/1 - Blue-black	: Rev-counter BB (+) to H.T. coil I
11 - Grey	: Oil pressure cutout P to oil pressure indicator FF
12 - Red	: Generator T to warning light EE
13 - Black	: Distributing block D to horn M (T—)
14 - Red	: Terminal block C to ignition switch Q (15-54)
15 - White	: Distributing block D to speedometer AA
16 - Yellow-black	: Distributing block D to warning light CC
17 - Brown	: Terminal block C to ignition switch Q (Int.)
18 - White-black	: Terminal block C to warning light EE
19 - Green	: Distributing block D to light switch E
20 - Green-black	: Distributing block D to light switch E
21 - Grey-red	: Distributing block D to light switch E
22 - Brown	: Terminal block C to light switch E
23 - Black	: Distributing block D to light switch E
25 - Black	: Stop light cutout O to tail light bulb S
26 - Black	: Regulator U to ground
27 - Black	: Battery V to ground
28 - Black	: H.T. coil 1 to contact breaker H
29 - Black	: H.T. coil 1 to distributor G
29/A - Black	: H.T. coil 1 to revcounter BB
30 - Black	: Distributor G to spark plug F
31 - Black	: Distributor G to spark plug F
37 - Black	: Headlight B to ground
37/A - Black	: Rev-counter BB to ground
37/B - Black	: Starter motor solenoid Z to neutral indicator N
41 - Green-black	: Distributing block D to high beam filament B
42 - Green	: Distributing block D to low beam filament B
43 - Black	: Headlight bulb B to ground on distributing block D

Legend:

- A HEADLIGHT
- B MAIN DRIVING LIGHTS
- C TERMINAL BLOCK WITH FUSES
- D DISTRIBUTING BLOCK
- E LIGHT SWITCH AND HORN BUTTON
- F SPARK PLUGS
- G DISTRIBUTOR
- H CONTACT BREAKER
- I H.T. COIL
- L STARTER BUTTON
- M HORN
- N NEUTRAL INDICATOR CUTOFF
- O STOP LIGHT CUTOFF
- P OIL PRESSURE CUTOFF
- Q IGNITION SWITCH- R NUMBER PLATE AND TAIL LIGHT
- S PLATE ILLUMINATION AND STOP LIGHT
- T GENERATOR
- U REGULATOR
- V BATTERY
- Z STARTER MOTOR SOLENOID
- X STARTER MOTOR
- AA SPEEDOMETER (with illumination bulb)
- BB REV-COUNTER (with illumination bulb)
- CC LIGHTS INDICATOR (green)
- DD NEUTRAL INDICATOR (amber)
- EE GENERATOR CHARGE INDICATOR (red)
- FF OIL PRESSURE INDICATOR (red)

IGNITION SWITCH POSITION

- = 0 =
- = 1 = 30/30 - INT.
- = 2 = 30/30 - INT. 15/54
- = 3 = 30/30 - INT. 15/54 - 50

NB.: Position + 3 - does not serve on machines with starter button.

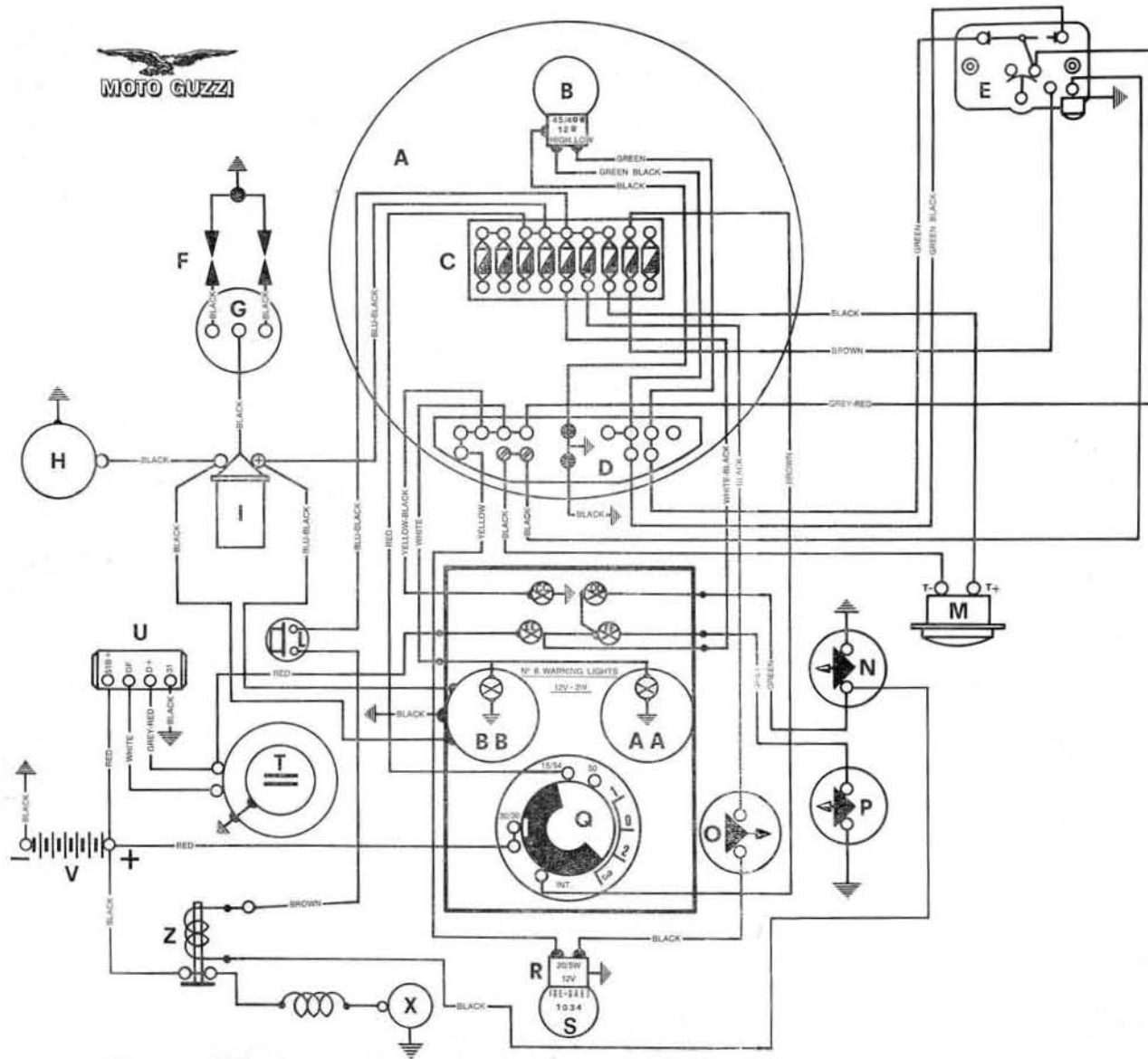

Fig. 29

TIPOGRAFIA SOTTOCORNOLA
LECCO - VIA VISCONTI, 16
1000 COPIE - DICEMBRE 1969



MOTO GUZZI