

V50



**owner's manual**

*This motorcycle has been designed and all components selected by the manufacturer to form a balanced, safe and mechanically cohesive motor vehicle. Any alteration to the frame, fork, other mechanical components or the use of unauthorized parts may alter the geometry, steering and handling qualities of the vehicle. Every owner of this motorcycle is cautioned against making these prohibited changes or alterations which may result in damage or injury for which neither the Manufacturer, Importer or Dealer will be responsible.*



*Dear Rider,*

*First of all we wish to thank you for choosing a Moto Guzzi motorcycle. By following the instructions outlined in this manual you will ensure a long and troublefree life for your machine.*

*Before riding, please read thoroughly this manual in order to know your motorcycle's features and how to operate it safely.*

*All major checking and overhaul jobs are best carried out by our dealers who have the necessary facilities to quickly and competently repair your Moto Guzzi.*

*Repairs or adjustments by any other than a Moto Guzzi dealer during the warranty period could invalidate the warranty.*

*This motorcycle has been designed and all components selected by the manufacturer to form a balanced, safe and mechanically cohesive motor vehicle. Any alteration to the frame, fork, other mechanical components or the use of unauthorized parts may alter the geometry, steering and handling qualities of the vehicle. Every owner of this motorcycle is cautioned against making these prohibited changes or alterations which may result in damage or injury for which neither the Manufacturer, Importer or Dealer will be responsible.*

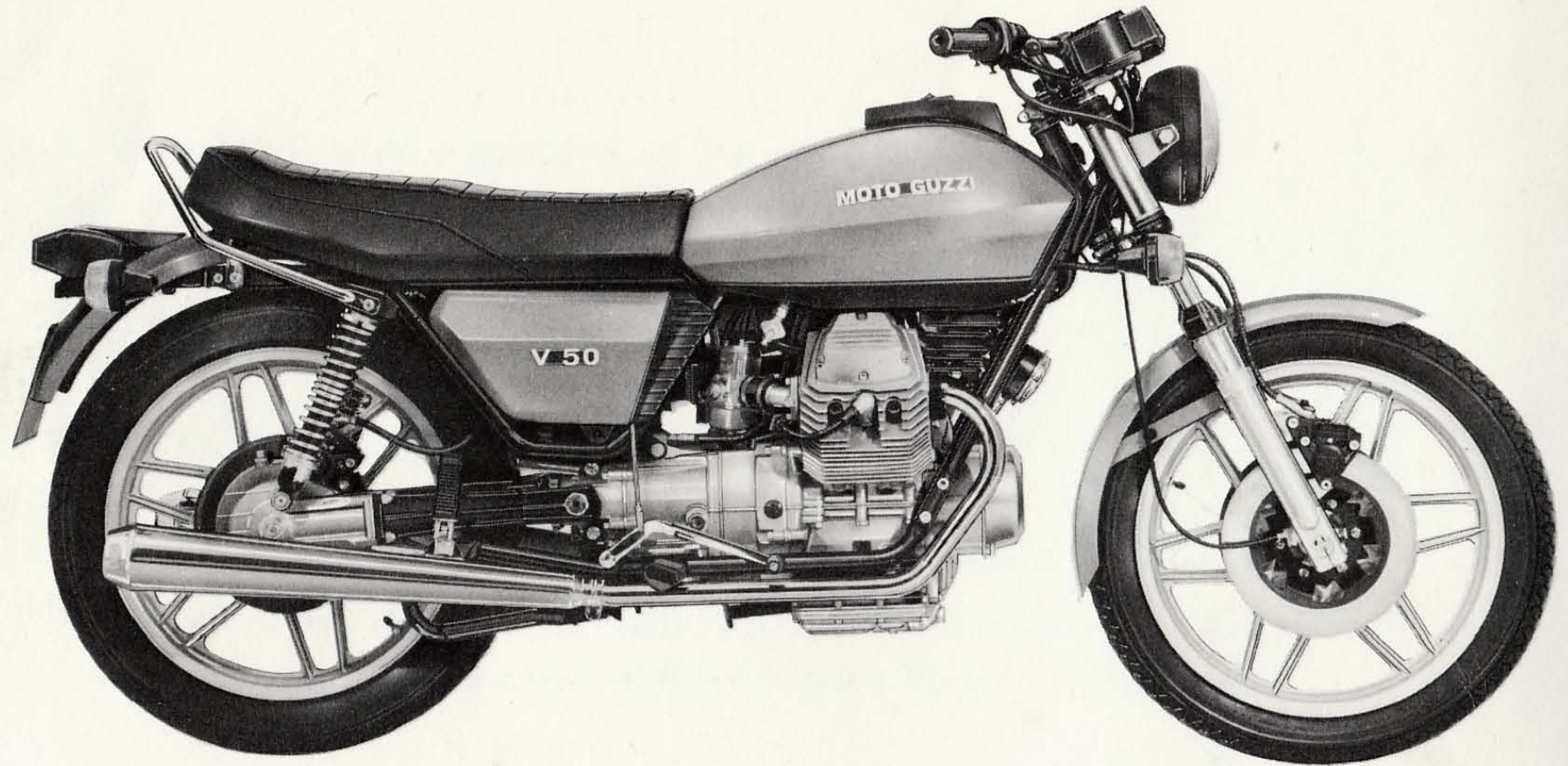



## INDEX

- 4 Main features
- 10 Controls and accessories
- 12 Identification data
- 13 Warranty
- 14 Instruments and controls
- 22 Riding instructions
- 24 Running in
- 25 Maintenance
- 32 Removal of wheels
- 36 Lubrication and maintenance chart
- 38 Lubrications
- 43 Carburation
- 47 Valve gearing
- 48 Ignition
- 53 Electrical equipment

## 4 MAIN FEATURES

### Engine

2-cylinder 4-stroke  
Cylinder disposition «V» 90°  
Bore mm 74  
Stroke mm 57  
Displacement cc 490,201  
Compression ratio 10,8 : 1

### Valve gearing

O.H.V. push rod operated.  
Timing data:  
Inlet opens 18° before TDC;  
closes 50° after BDC.  
Outlet opens 53° before TDC;  
closes 15° after BDC.  
Valve clearance for timing:  
checking 1 mm (0.0394 in).  
Valve rocker clearance:  
Inlet 0,10 mm (0.0039 in);  
Outlet 0,15 mm (0.0059 in).

### Lubrication

Forced, by lobe type pump.  
Oil pressure warning light on instrument panel.  
Wire gauze and cartridge oil filters.

**Ignition**

Electronic ignition with magnetic control.

The ignition advance varies electronically according to the engine revs. without involving any mechanical device.

Max. ignition advance: 35° before TDC at 5000 ÷ 5500 rpm.

Spark Plugs: Marelli CV 9 LP, Bosch W 260 T 30, Lodge 2 HLN. Points gap: 0,6 mm (0.023 in).

**Carburation**

N. 2 Dell'Orto Carburettors VHB 24 F (right «D» - left «S»).

**Cooling**

By air.

**Exhaust system**

N. 2 exhaust tubes and n. 2 connected silencers.

**Generator-alternator**

14 V - 20 A; situated at the front end of crankshaft.

**Starting**

Electric starter motor, kick starter on request.

**Transmission****Clutch**

Dry type, single plate. Hand controlled, lever on the L/H side of the handlebar.



**Primary drive**

By gears, ratio: ( $Z = 14/23$ ) 1 : 1,642.

**Gearbox**

5-speed, frontal engagement, constant mesh gears. Foot controlled, lever on the L/H side of the motorcycle.

**Cycle**

Ratio:

1st. speed ( $Z = 11/30$ ) 1 : 2,727

2nd. speed ( $Z = 15/16$ ) 1 : 1,733

3rd. speed ( $Z = 18/23$ ) 1 : 1,277

4th. speed ( $Z = 22/23$ ) 1 : 1,045

5th. speed ( $Z = 22/20$ ) 1 : 0,909

**Secondary drive**

Cardan shaft (bevel gear set).

Ratio ( $Z = 8/31$ ) 1 : 3,875

Overall gear ratio (engine/wheel).

1st. speed 1 : 17,351

2nd. speed 1 : 11,026

3rd. speed 1 : 8,125

4th. speed 1 : 6,649

5th. speed 1 : 5,783

**Frame**

Cradle type, tubular structure.

7

**Suspensions**

Telescopic front fork incorporating sealed hydraulic dampers.

Rear swinging fork with externally adjustable springs.

**Wheels**

In light alloy with rims:

front WM 3/1,85 x 18 CP2;

rear WM 3/2,15 x 18 CP2.

**Tires**

Pirelli: front 3,25 S 18 (rigato)

rear 100/90 S 18 (MT 15)

Michelin: front 3,00 S 18 (C 5)

rear 3,50 S 18 (C 66)

Metzeler: front 3,00 S 18 (M 38)

rear 3,50 S 18 (M 38)

**Brakes**

Front: hydraulic disc brake, twin braking cylinder caliper. Hand controlled, lever on the R/H side of the handlebar.

Disc  $\varnothing$  300 mm

Braking cylinder  $\varnothing$  32 mm

Master cylinder  $\varnothing$  12,7 mm

Rear: hydraulic disc brake, twin braking cylinder caliper. Foot controlled, lever on the R/H side of the motorcycle.

Disc  $\varnothing$  235 mm

Braking cylinder  $\varnothing$  32 mm

Master cylinder  $\varnothing$  15,875 mm

The rear brake is bound by a hydraulic transmission to a twin front brake featured and dimensioned like the right front hand controlled brake.

#### Overall dimensions & weight

Wheelbase m 1,395 (55" a.)

Max. length m 2,080 (82" a.)

Max. width m 0,750 (29,5" a.)

Max. height m 1,035 (39,5" a.)

Weight (without fuel, lubricators and tool kit)  
kg 152 (335 lbs. a.).

#### Performances

Max. speed solo riding: a. 170 km/h (105 mph.).

Fuel consumption: 4 l x 100 km  
(1 US gls. x 60 mi. a.).

*All data subject to change without prior notice.*



## Fuel and oil capacities

Group or part	Quantities	Recommendation
Fuel tank (Reserve 2 l) (4 <sup>1</sup> / <sub>4</sub> us pints - 3 <sup>1</sup> / <sub>2</sub> imp pints)	16,5 (4,35 US gls.)	Petrol super 98/100 NO-RM
Sump	2,250 (5.8 US pints - 4 <sup>1</sup> / <sub>2</sub> imp pints)	Oil «Agip Sint 2000» SAE 10 W/50
Gearbox	1 (2.1 US pints - 1.2 imp pints)	Oil «Agip F.1 Rotra MP» SAE 140
Rear drive box	0,160 (10 cu in.) 0,010	Oil «Agip F.1 Rotra MP» SAE 140 Oil «Agip Rocol ASO/R»
Front fork (p. leg)	0,070 ( 4 cu in.)	Oil «Agip F.1 ATF Dexron»
Front and rear braking circuits		Agip F.1 Brake Fluid SAE J 1903

Where «Agip» brand oil is unavailable, use other equivalent good quality oil.

## 10 **CONTROLS AND ACCESSORIES**

(Pict. 2)

- 1 Caliper, front brakes.
- 2 Headlight.
- 3 Front turn signals.
- 4 Right front brake control lever.
- 5 Throttle control grip.
- 6 Engine starting and stopping button (emergency).
- 7 Button controlling opening of cover for fuel and brake fluid filling caps
- 8 Left front and rear brake control pedal.
- 9 Foot-rest front.
- 10 Master cylinder controlling left front and rear brakes.
- 11 Foot-rest rear.
- 12 Rear turn signals.
- 13 Tail light.
- 14 Tachometer.
- 15 Warning light panel.
- 16 Rev. counter.
- 17 Clutch control lever.
- 18 Buttons controlling: horn, flashing light and turn signals.
- 19 Light switch.
- 20 Key switch.
- 21 Master cylinder controlling right front brake.
- 22 Fluid reservoir for front and rear brakes.
- 23 Gear change control pedal.
- 24 Starter control lever on carburettors.
- 25 Side stand.
- 26 Center stand.
- 27 Rear suspensions with hydraulic dampers.

*R/H and L/H as seen in riding position.*

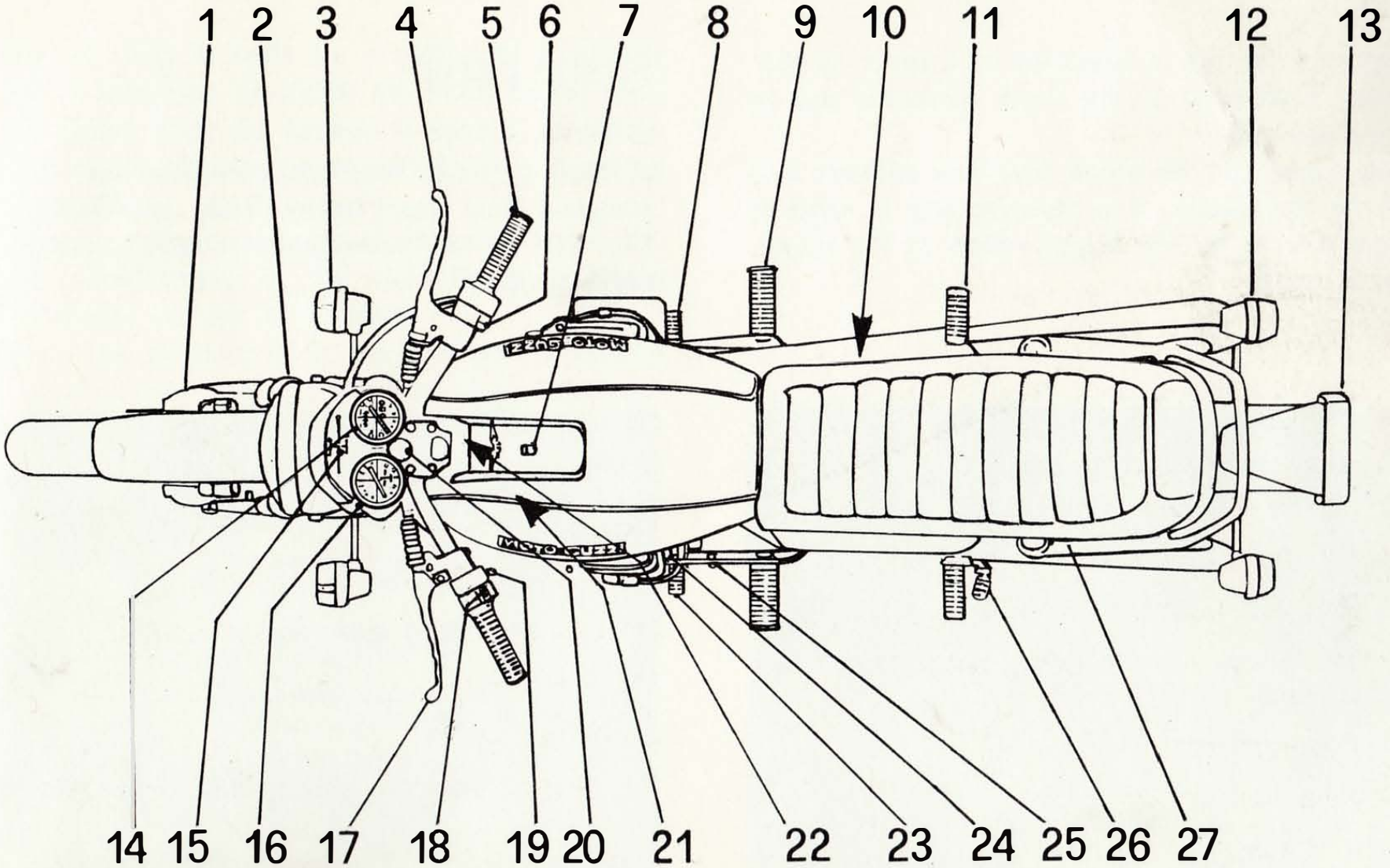



## 12 IDENTIFICATION DATA

Every motorcycle is identified by a serial number which is stamped on the frame downtube and on the crankcase.

The number on the frame downtube appears also on the certificate of conformity and is valid to legal effects for the identification of the motorcycle itself.



## Spare parts

In case of parts replacement make sure that «Original Moto Guzzi Spare Parts» only are used. The use of non-genuine parts invalidates the warranty right.

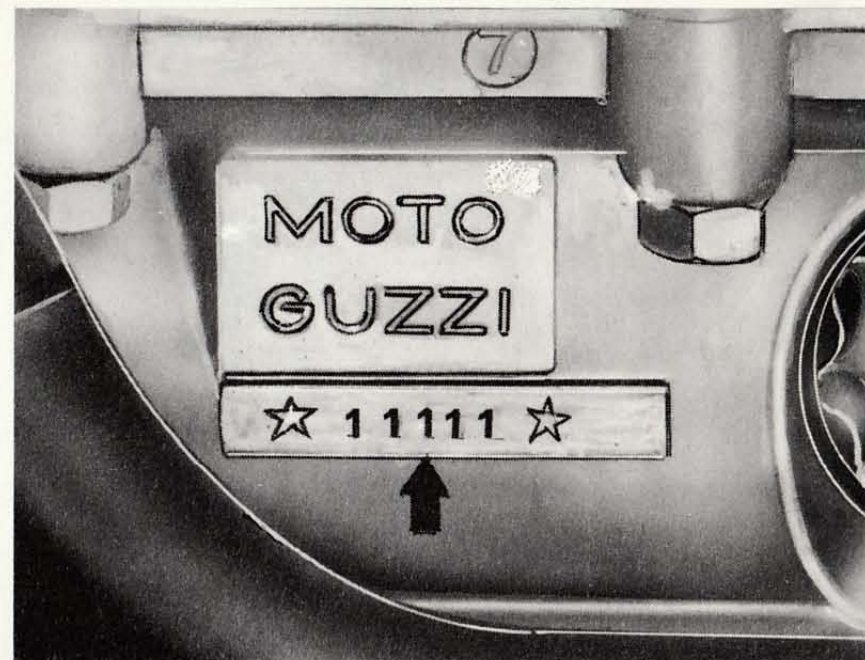

## **WARRANTY**

**The warranty is valid for a period of 6 months with a limitation to 10.000 km (6000 miles) from the selling date and expires in case of modifications to the motorcycle or participation in racing competitions.**

**Tires as well as parts or accessories which are not manufactured in the «SEIMM Moto Guzzi Factories» are out of warranty.**

Each new motorcycle is supplied with a service voucher book. This has to be carefully kept with all other circulation papers as it is the only document entitling the owner of the motorcycle to be recognized the warranty from «SEIMM Moto Guzzi».



## 14 INSTRUMENTS AND CONTROLS

### Instrument panel (Pict. 4)

- 1 Tachometer with zero setter.
- 2 Rev. counter.
- 3 (n) Neutral indicator (orange). Comes on when gearbox is in neutral.
- 4 (l) Parking light indicator (green).
- 5 (oil) Oil pressure indicator (red). Goes out

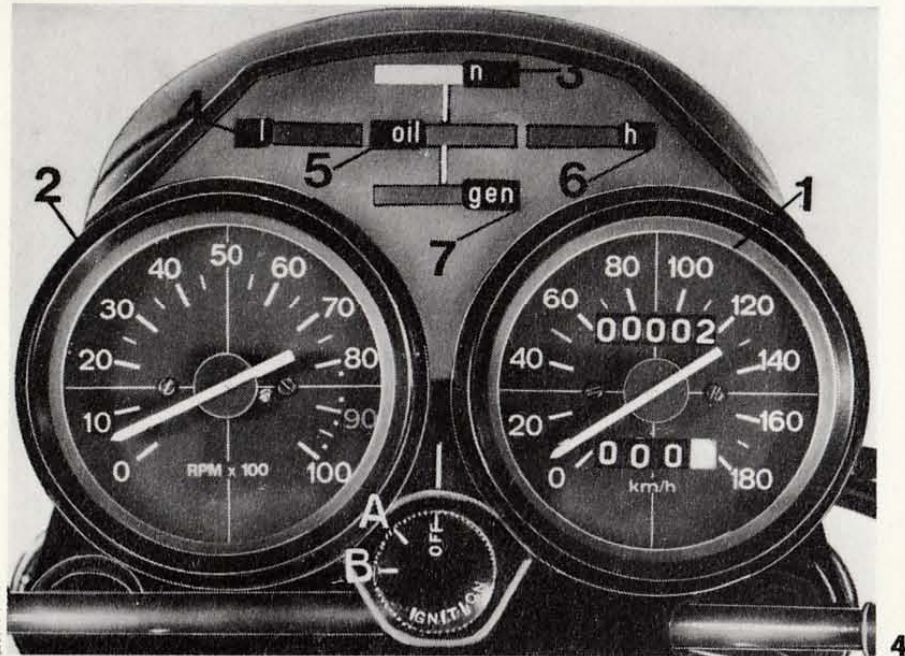

when pressure is sufficient for normal engine lubrication. If not, the pressure is incorrect and the engine has to be stopped and the lubricating system checked over.

6 (h) High beam indicator (blue).

7 (gen) Red warning light indicating insufficient flow of current from generator for battery charge. Should go out when the engine reaches a certain number of revolutions.

*When driving in daylight all warning light should be off. At night, the parking light or eventually the high beam light only should be «ON».*

### Ignition key switch (Pict. 4)

The key has 3 positions:

- «OFF» In line with the p stationary, key removable.
- «A» In line with the panel mark (turned clockwise). Machine ready be started, all controls in. Key not removable.

- «B» In line with the panel mark (turned clockwise). Parking light ON with switch «A» (Pict. 5) in position «O». Key removable.

## Light Switches (Pict. 5)

They are located on the L/H side of the handlebar.

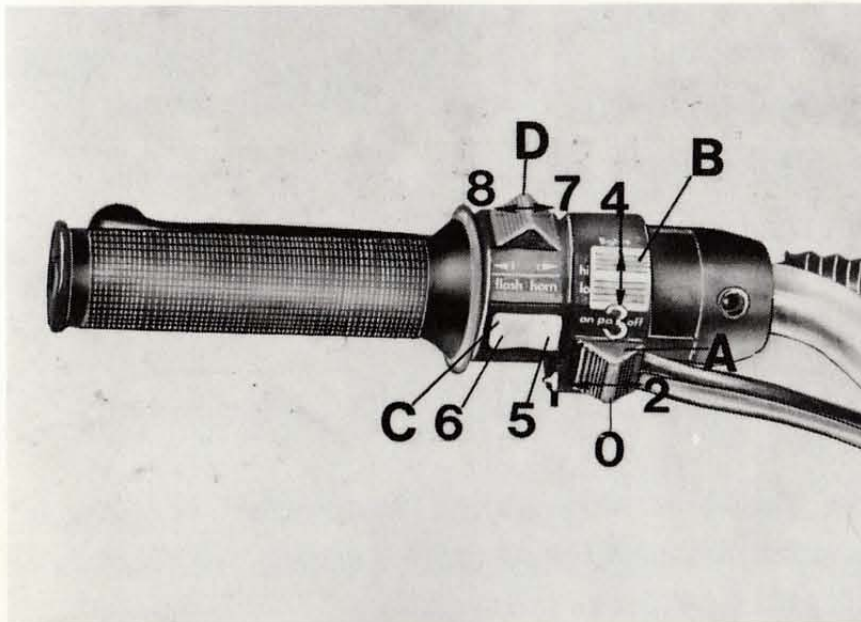

### Switch «A»

- Position «0» Parking light.
- Position «1» Low beam.
- Position «2» Light off.

### Switch «B»

With switch «A» in position «1».

- Position «3» Low beam.
- Position «4» High beam.

## Buttons controlling: horn, flashing light, Turn signals (Pict. 5)

They are located on the L/H side of the handlebar.

### Button «C»

- «5» HORN Horn control.
- «6» FLASH Flashing light control.

### Button «D»

- «7» Right turn signal control.
- «8» Left turn signal control.



## 16 Engine starting and stopping button (emergency) (Pict. 6)

They are located on the R/H side of the handlebar.

With ignition key in position «A» (Pict. 4), the motorcycle is ready to be started.

To start the engine operate as follows:

- ensure that switch «B» is in position «1» (run);
- draw the clutch control lever fully;

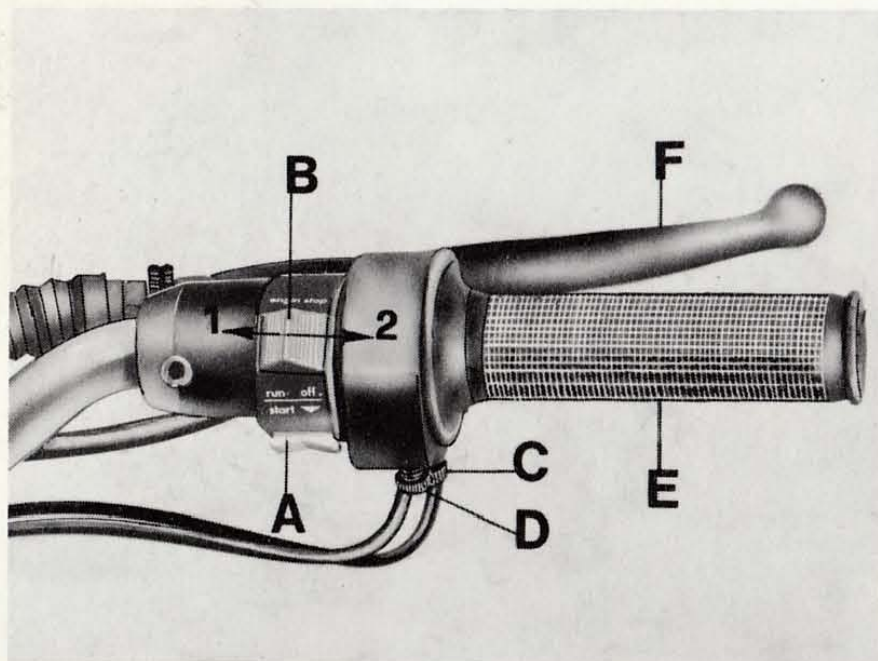

6

- with a cold engine set the starter lever (Pict. 28) to position «A»;

- press starting button «A» (start).

To stop the engine in case of emergency:

- set switch «B» to position «2» (OFF);
- after stopping the engine turn the key (Pict. 5) counterclockwise until the mark «OFF» is in line with the panel mark, then remove the key.

## Starter control lever (Pict. 28)

The control lever for starting a cold engine is located on the L/H side of the motorcycle.

- «A» starting position;
- «B» riding position.

## Throttle control grip («E» Pict. 6)

On the R/H side of the handlebar. Throttle is opened by turning the grip towards the rider and closed viceversa.

### Clutch control lever («E» Pict. 5)

On the L/H side of the handlebar. To be used for starting and gearshifting only.

- 2nd. 3rd. 4th. 5th. speed: pedal up;
- neutral position: between 1st. and 2nd. speed.

*Before operating the gear change control pedal, the clutch lever has to be fully pulled in.*

### Right front brake control lever («F» Pict. 6)

On the R/H side of the handelbar. It controls the master cylinder for right front hydraulic brake.

### Left front and rear brake control pedal («B» Pict. 18)

On the R/H side of the motorcycle, link connected to the master cylinder. It controls both the left front and the rear brake simultaneously.

### Gear change control pedal (Pict. 7)

On the L/H side of the motorcycle.

- 1st. speed: pedal down;

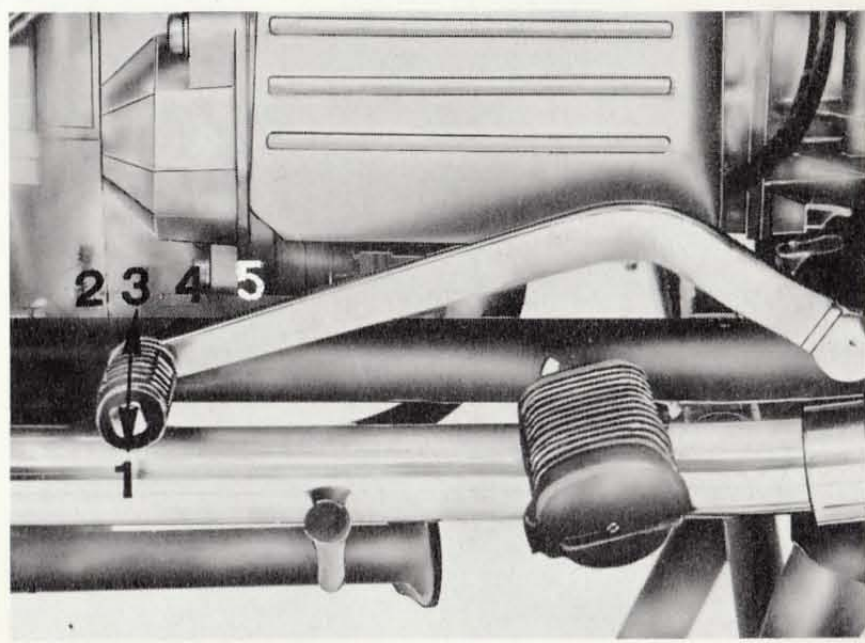

7



## 18 Fuel filler cap (Pict. 8)

To lift the cover complete with fuel filler cap, press control button «A».

## Brake fluid reservoir for master cylinders controlling front and rear braking circuits (Pict. 9)

Access to this reservoir is made possible by

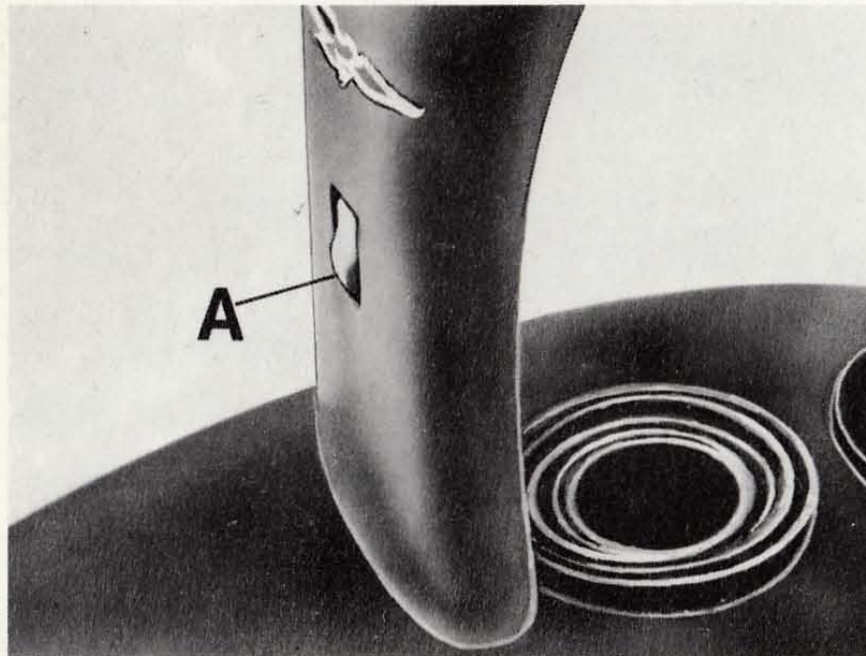

pressing button «A» (Pict. 8) and lifting the cover with fuel filler cap.

To check the fluid level, remove cap «B» from reservoir «A» and ensure that the fluid always covers the reservoir partition (min. level) in two sides, the one for the right front brake and the other for the left front and rear brake.

## Fuel taps (Pict. 10)

They are located under the fuel tank, rear side.

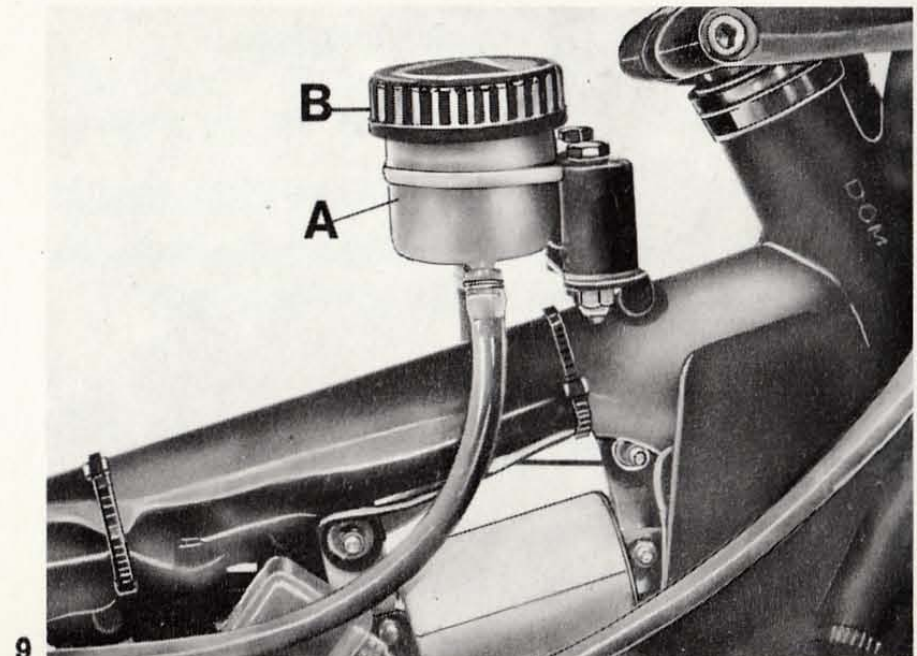



The taps lever has three positions:

- «ON» open, arrow upwards.
- «RES» reserve, arrow downwards.
- «OFF» closed, arrow horizontal.

## Terminal block with fuses (Pict. 11)

It is located at the center of the motorcycle. Access to it is by lifting the saddle (See chapter «Saddle locking device»), undoing the cover retaining screw, and removing the cover.

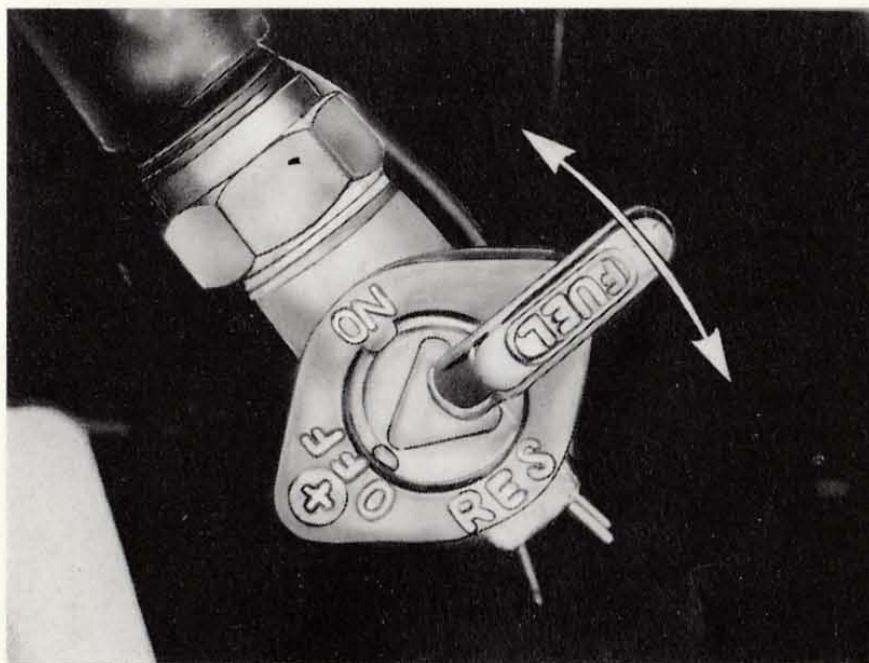

The box fits 4 fuses of 16 A.

- Fuse n. 1: Rear brake light, turn signals.
  - Fuse n. 2: Starter relay, front brake light, flashing light relay, horn.
  - Fuse n. 3: Warning lights (Gen-oil-n), high beam and warning light, low beam.
  - Fuse n. 4: Parking light, front and rear, panels lights, warning light «I».
- Before replacing a fuse, it is necessary to eliminate the defect causing its burning.

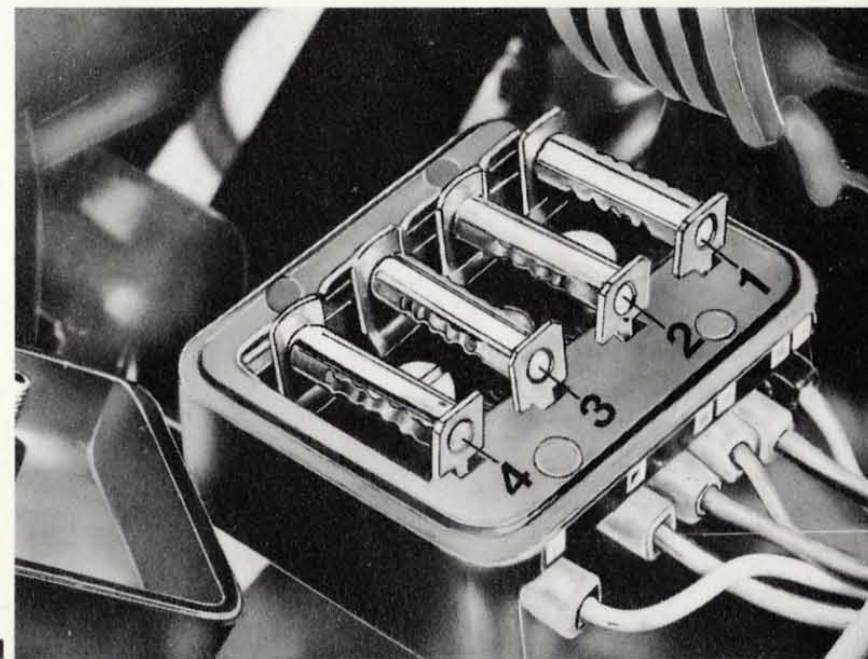

## 20 Steering locking («A» Pict. 12)

To lock:

- turn handlebar fully to the right;
- insert the key into the lock set, turn it counterclockwise and push fully in, release, and take off.

To release:

- insert the key into the lock set, turn it counterclockwise then release and take off.



## Saddle locking device (Pict. 13)

On the L/H side, rear.

To lock:

- push the saddle down until to hear «B» hooks click.

To release:

- shift the lever «A» towards the front wheel (see the arrow) to unhook hooks «B», then lift the saddle.

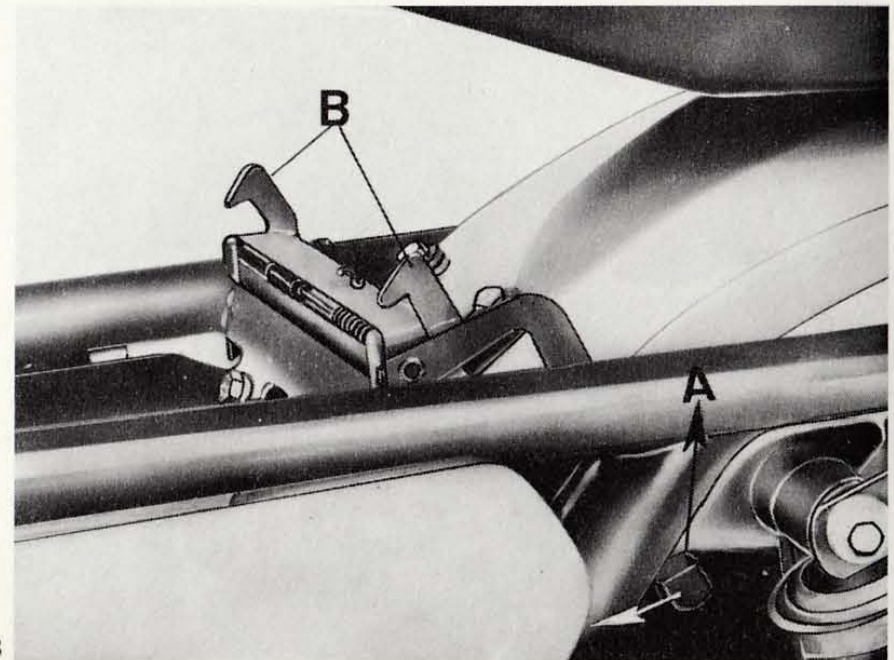



# Side stand («A» Pict. 14)

Should be used only for short stops.  
Be sure to raise it when re-starting or else serious troubles may occur.

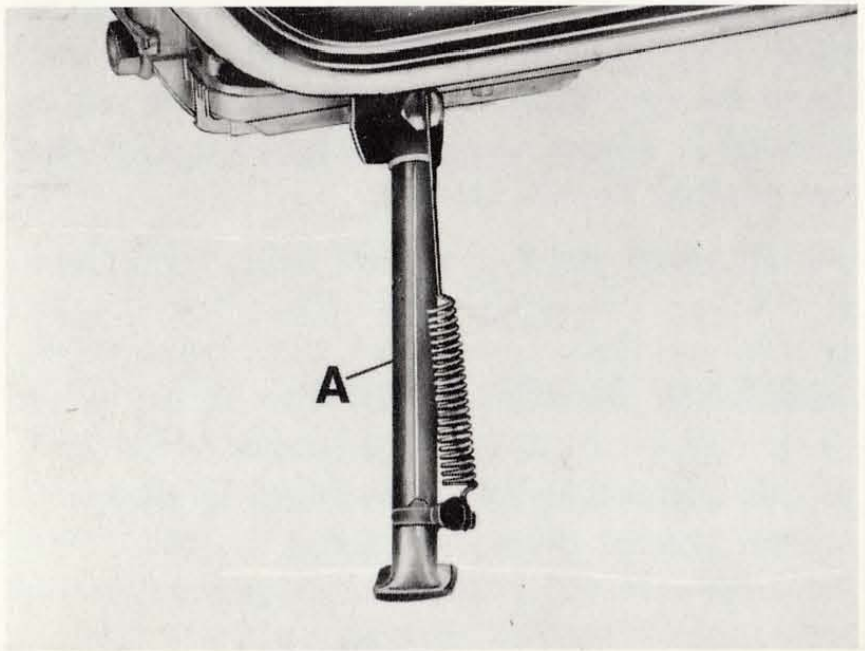

14



## 22 RIDING INSTRUCTIONS

### Checking

Before starting the engine ensure that:

- there is sufficient fuel in the tank;
- the oil in the engine sump is at correct level;
- the ignition key is in position «A» (see Pict. 4);
- the following warning lights are lit: **red** (oil pressure, generator); **orange** (neutral indicator); **green** (parking light [town driving] for night riding);
- the starter lever for a **cold engine** is in starting position («A» Pict. 28).

### Starting a cold engine

After checking all the above, open the throttle grip  $\frac{1}{4}$  turn, pull the clutch lever fully, eventually move switch «B» (Pict. 6) to position «1» (ride), and press start button «A» (start) Pict. 6.

When the engine has started, let it idle for a few

seconds in the hot season and a few minutes in the cold season before returning the start lever.

**Should the starter lever be left on «A» (Pict. 28) whilst riding, carburation will be irregular with a greatly increased fuel consumption and worse still the possibility of seizures due to too much fuel going into the cylinders.**

*Caution: If the orange warning light is not lit, with the ignition key in starting position (Pict. 4) this means that the gearbox is not in neutral position. An engine starting under that circumstance could be very dangerous; it is therefore recommended to always ensure the gearbox is in neutral position before starting.*

### Starting a hot engine

In this case it is not necessary to place the starter control lever to starting position («A» Pict. 28) as this would richen the carburation too much.

## On the way

To change to another gear, close the throttle, pull the clutch control lever fully in and engage the new gear; release gently the clutch lever and open the throttle at the same time.

The gear change pedal has to be firmly actuated and foot accompanied.

When shifting down to a lower gear, operate brakes and throttle control grip gradually so as not to cause the engine to **over rev** when the clutch lever is released.

## Stopping the motorcycle

Close the throttle, pull both brake levers gently, and pull the clutch lever when the machine is almost to standstill in order to avoid overrevving of the engine when the clutch lever is released. To normally reduce speed, use the engine braking power by correctly changing gear and paying attention not to cause the engine **to over rev**.

On wet or slippery roads, the brakes, especially the right front one, have to be carefully operated.

To stop the engine turn the ignition key to position «OFF» (Pict. 4).

**When the engine is stopped, remember to close the fuel taps.**

## Parking

When parking on insufficiently lighted roads, it is necessary to leave the parking lights on, by turning the ignition key (Pict. 4) to position «B» and the light switch (Pict. 5) to position «0». Then take off the key and lock the steering (see chapter «Steering locking» - Pict. 12).

## 24 RUNNING IN

During the running in period follow strictly these recommendations:

- 1 Before starting allow the engine to warm up letting it idle for a more or less period of time, according to the temperature.
- 2 Never exceed the maximum permissible speeds in each gear. Avoid riding at the same number of revolutions for long periods but change gear frequently.

### MAXIMUM RUNNING IN SPEEDS

Distance covered	Maximum permissible speed				
	1st. gear	2nd. gear	3rd. gear	4th. gear	top gear
Up to 800 kms (500 miles)	35 (22 mi.)	55 (34 mi.)	77 (47 mi.)	95 (60 mi.)	115 (72 mi.)
From 800 kms (500 miles) to 1600 kms (1000 miles)	50 (31 mi.)	75 (47 mi.)	100 (62 mi.)	115 (72 mi.)	130 (81 mi.)
From 1600 kms (1000 miles) to 3000 kms (1900 miles)	Gradually increase the above limits up to the maximum admissible speed.				

#### After the first 500 (300 mi.) ÷ 1000 km (600 mi.)

Change the engine lubricating oil. Should the oil level fall under the min. mark before the engine has reached 500 ÷ 1000 km (300 ÷ 600 mi.), it will also be necessary to change the oil, instead

3 Before stopping, reduce the speed gradually to prevent the various engine assemblies from undergoing abrupt changes of temperature.

4 Make sure all the operations specified in the service voucher are carried out at the stated mileages.

5 Don't forget that a proper bedding down of all components will only occur after several thousands of miles have been covered. This will allow you to obtain an excellent performance of your motorcycle for a long period of time.

of topping up.

Tighten all nuts and bolts.

Adjust valve rocker clearance.

Check tire pressure.

Check ignition timing (see chapter «Ignition»).



## MAINTENANCE

### Adjusting the clutch control lever (Pict. 15)

If the free play at the handlebar lever is more or less than  $3 \div 4$  mm, screw in or out adjuster «A» to obtain the correct play.

This adjustment can also be carried out by slacking nuts «C» and acting on adjuster «B» that is located on the R/H side of the gearbox.

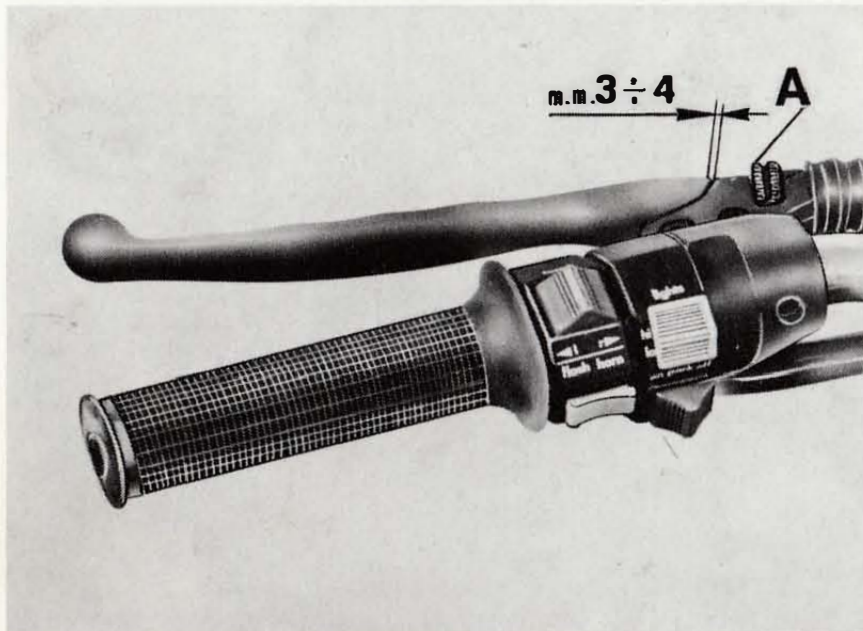

15

### Adjusting the right front brake control lever (Pict. 16)

If the free play at the handlebar is more or less than  $3 \div 4$  mm, act on adjuster «A» to obtain the correct play.

This adjustment can also be carried out by slacking nuts «C» and acting on adjuster «B».

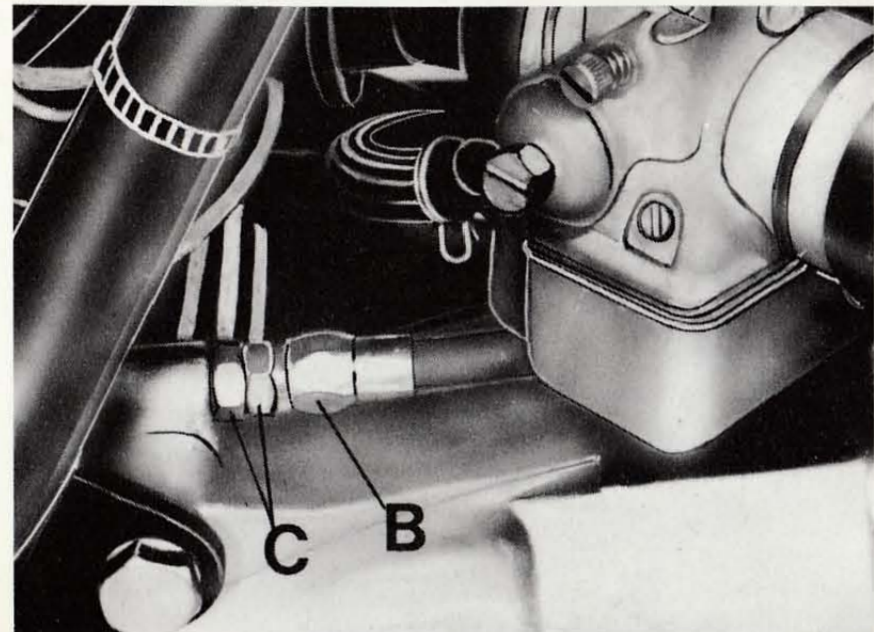

## 26 Checking brake pads wear

Every 5000 km (3000 mi.) check the brake pad thickness:

- new pad: 7 mm (0.275 in.);
- wear limit: 3,5 mm (0.14 in.).

If the thickness is under the wear limit, it will be necessary to replace the pads. After a pad replacement it is not necessary to bleed the air from

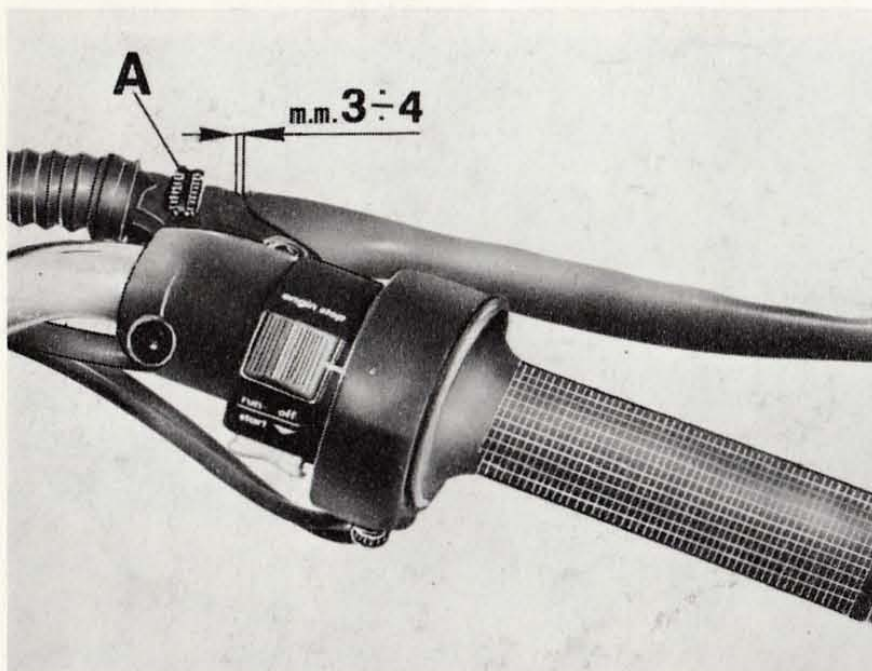

braking circuits but only operate the control lever «B» (Pict. 17) several times until the pistons in calipers reach their normal position.

Check also the condition of the fluid pipes; should they be damaged, replace them immediately.

**For about 100 km (60 mi.) after a pad replacement it will be necessary to carefully actuate the brakes in order to allow the pad to properly bed down.**

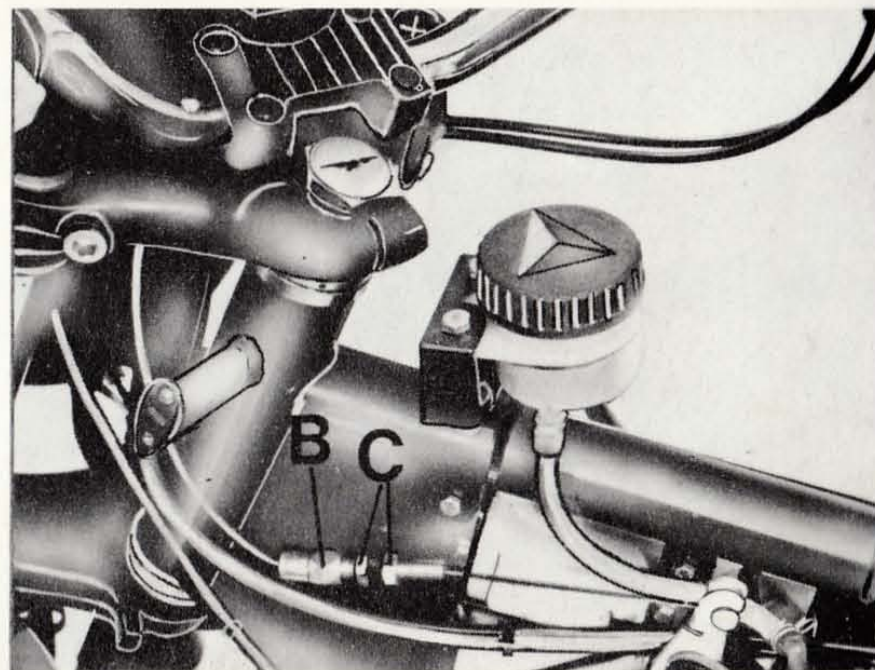



## Checking the brake discs

(«G» Pict. 17-18)

The brake discs must be accurately clean and without oil, fat, or other dirt and must not show any deep scoring.

In case of replacement or overhauling of the brake disc, it is necessary to check its wobbling. This checking is carried out by means of a proper gauge that must never read more than 0,2 mm (0.0078in.).

Should wobbling be higher, carefully check the

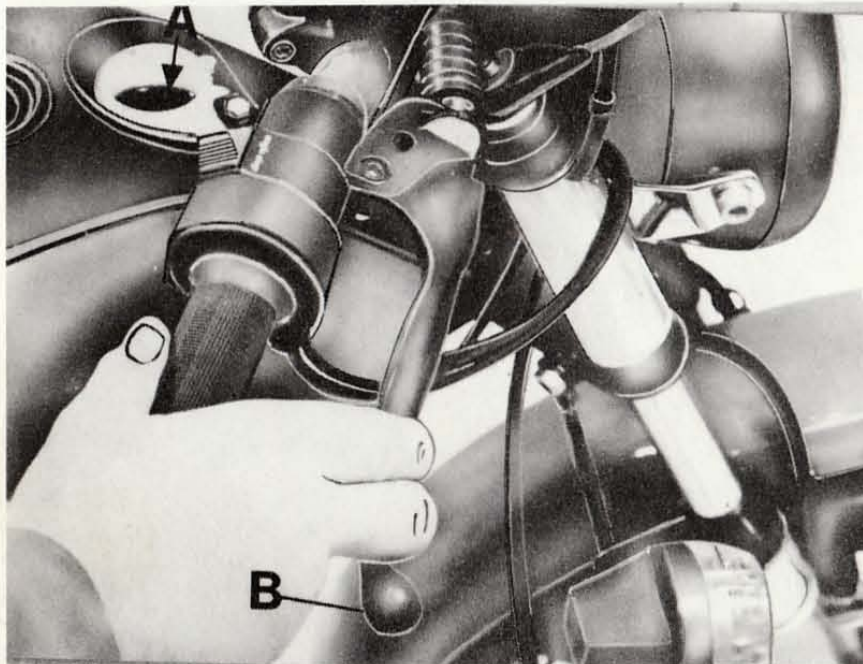

mounting of the disc on the hub and the play of the hub bearings. Torque wrench setting for the disc-hub securing screws is  $2.2 \div 2.4$  kgm (15-17 lbs/ft.).

## Checking the brake fluid level and changing the brake fluid in reservoir (Pict. 9-17)

For a good working of brakes, these directions are to be strictly followed:

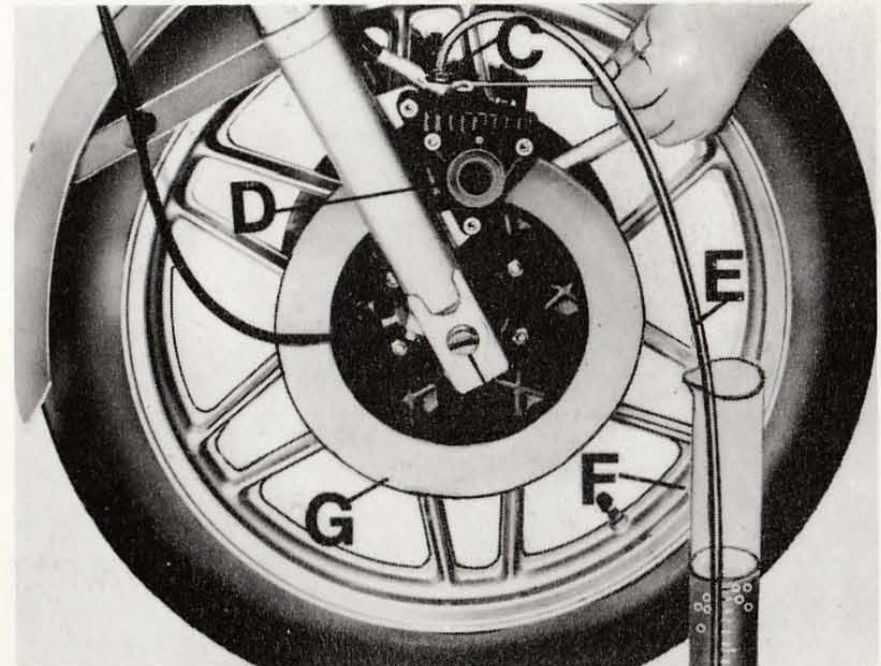



1 Periodically check the fluid level in reservoir «A» (Pict. 17). It must never fall under the reservoir partition.

2 Periodically or whenever necessary top up fluid reservoir «A», after loosening cap «B» and taking off the gaiter (Pict. 9).

**For topping up use only fresh fluid taken from sealed containers to be opened just before use.**

3 Completely renew the brake fluid every 15.000 km (9500 mi.) or at least once a year. The fluid flexible pipes have to be always full and without air; a long and elastic movement of the control lever «B» evidences the presence of air inside the pipes themselves.

When cleaning the braking circuits use only fresh fluid. Never use alcohol to clean or compressed air for drying; use Trichloroethylene for metal parts.

For eventual lubrications do not use mineral oils or greases. If no proper lubricants are available, it is recommended to moisten rubber and metal parts with brake fluid.

Fluid to be used: «Agip F.1 Brake Fluid - SAE J 1703».

## Bleeding the air from the braking circuits (Pict. 17-18)

This operation is required when the movement of the control lever on the handlebar or control pedal is long and elastic because of the presence of air inside the braking circuits.

This is done as follows:

### Right front braking circuit (Pict. 17)

- set the motorcycle up on the center stand;
- if necessary top up the fluid reservoir «A» (ensuring that during the air bleeding operation the fluid level does not fall under the reservoir partition);

- to bleed operate on caliper «D»:

1 take out the rubber cover then fit a transparent flexible pipe «E» onto drain plug «C»; the other end of this pipe will be plunged into a transparent container «F» partially filled up with fluid of the same type;

2 loosen drain plug «C»;

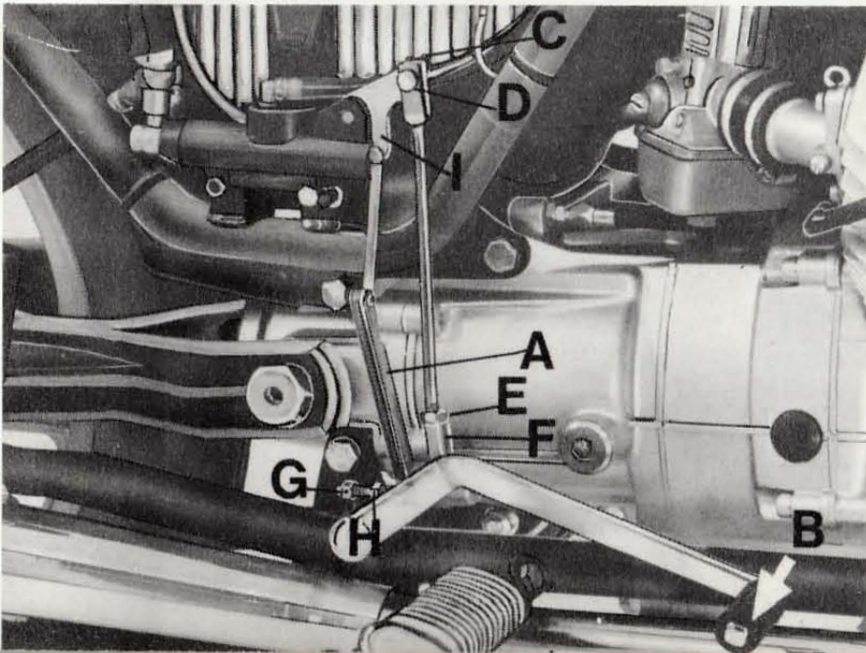
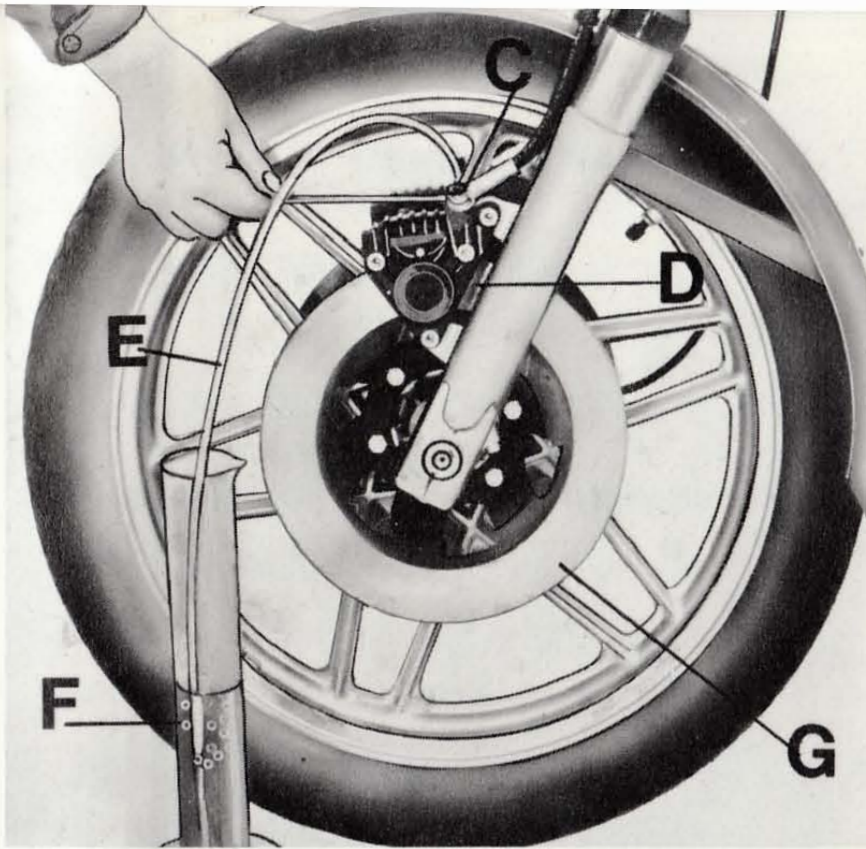

3 fully draw control lever «B», release it slowly and wait for a few second before drawing it again. Repeat this operation until no more bubbles come out from the pipe end in the container;

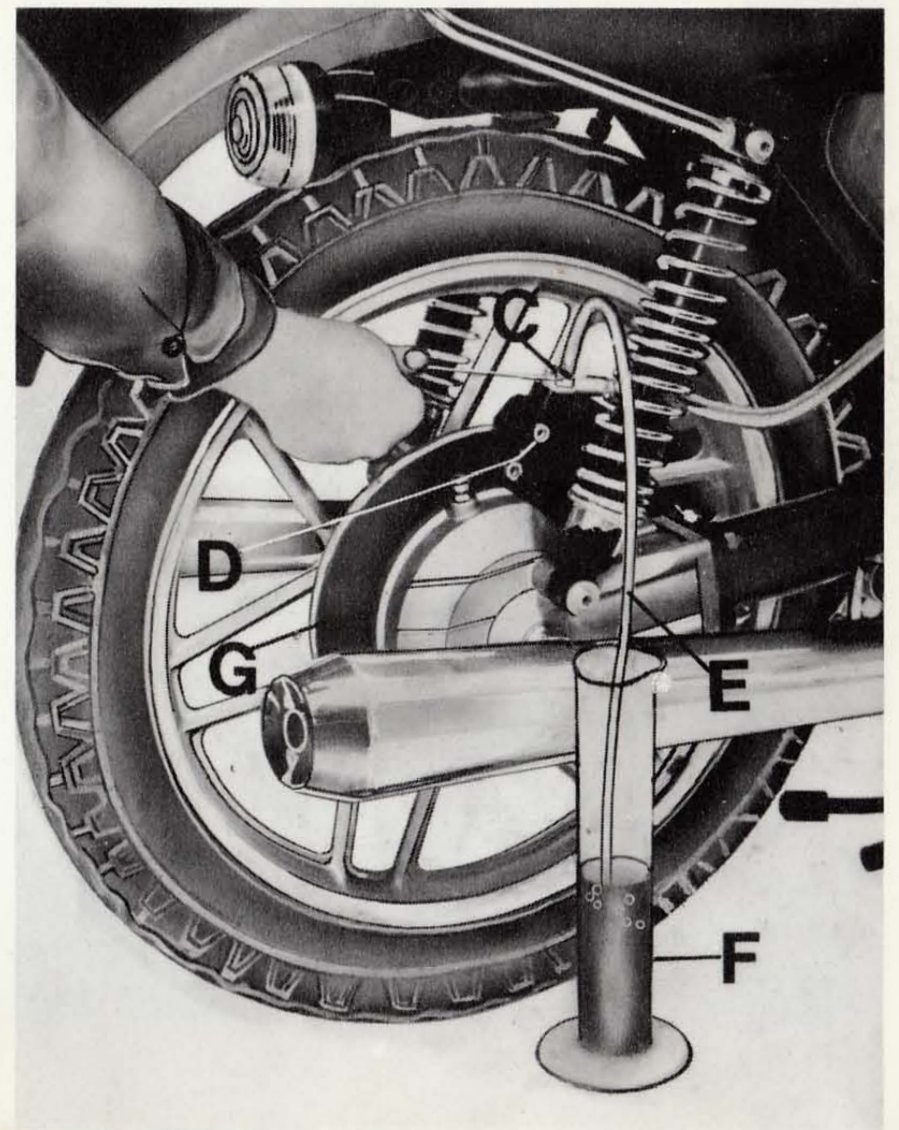



4 keep control lever «B» fully drawn and lock drain plug «C». Then remove pipe «E» and re-fit rubber cover onto the drain plug.

If the air bleeding has been correctly carried out, a direct and efficient working of the fluid will be felt immediately after lever «B» is pulled. If not, the operation has to be repeated.

## Front left and rear braking circuit

(Pict. 18)

See previous chapter, except points «3» and «4».

### Point «3»

- fully operate control pedal «B»...

### Point «4»

- keep the control pedal «B» fully drawn...

## Adjusting the control pedal for front left and rear brake

(Pict. 18)

Check the clearance between floater in master cylinder and control lever «1» operating as follows:

- fit a feeler gauge «A» between floater in master cylinder and control lever end;
- correct play:  $0.05 \div 0.15$  mm ( $0.0019 \div$
- in case of incorrect play:
  - Remove split pin «C», take out pin «D», loosen nut «E», and screw in or out fork «F» to attain the ideal position for control pedal «B».
  - Re-fit pin «D» and split pin «C».
  - Then loosen nut «G» and adjust return lever screw «H».

## Adjusting the rear suspensions

(Pict. 19)

The external springs of rear suspensions can be adjusted to three positions by means of wrench «A».

In case of faulty damper operation, have them checked by our dealers.

*Do not forget that the two spring have to be adjusted to the same position to ensure a good stability of the motorcycle.*



## Adjusting the steering (Pict. 19)

For safe riding the steering has to be adjusted so that the handlebar can move freely without any play.

Operate as follows:

- slacken steering head fixing bolt «A»;
- undo nut «B»;
- by the aid of a drift, screw in or out locking «C» to take up the excessive play.

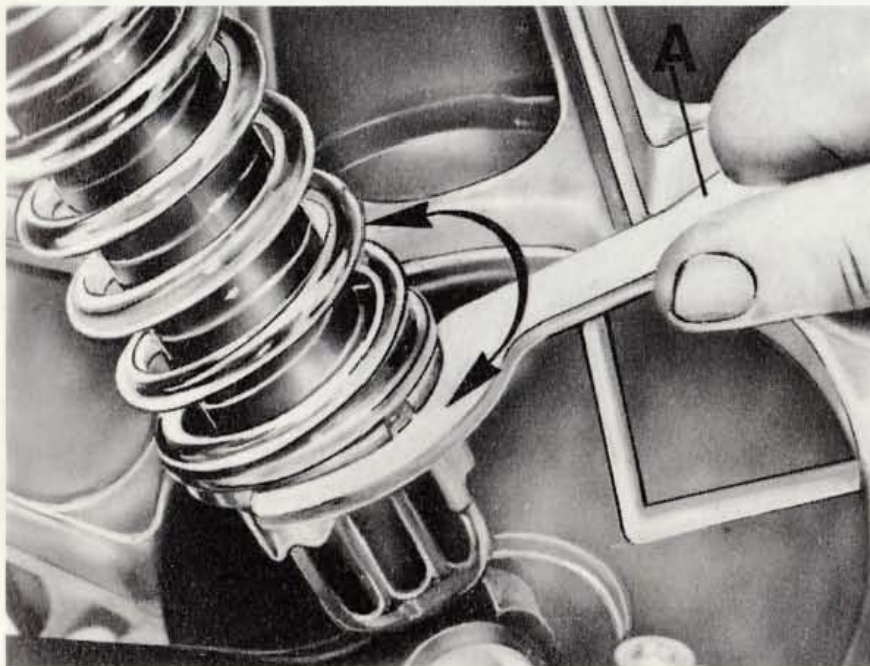

After adjustment, re-lock nut «B», and steering head bolt «A».

*It is recommended to have this operation carried out by our dealers.*

## Adjusting the twist grip control («C» and «D» Pict. 6)

To adjust the grip travel, screw in or out adjuster «D».

To adjust the grip return, screw in or out adjuster «C».

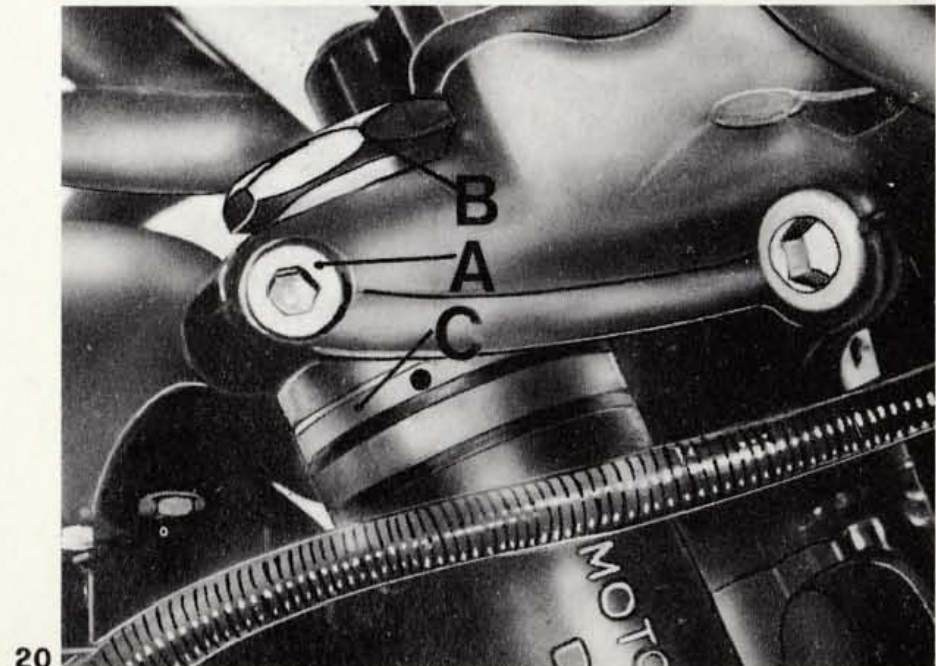

## 32 REMOVAL OF WHEELS

### Front wheel (Pict. 21)

- set up the vehicle on the center stand and place a block under the engine crankcase to free the wheel from the ground;
- undo the screws securing the brake caliper to the left fork cover and remove caliper «A» with pipe;
- undo wheel spindle lock nut «B» (left side);
- undo screws «C» securing fork covers to wheel spindle;
- slip off spindle «D»; paying attention to the position of washer «E» and spacer «F»;
- disengage the right braking disc from its caliper and take the front wheel off fork rods.  
To re-fit the wheel reverse the operations.

### Rear wheel (Pict. 22)

- set up the vehicle on the center stand;

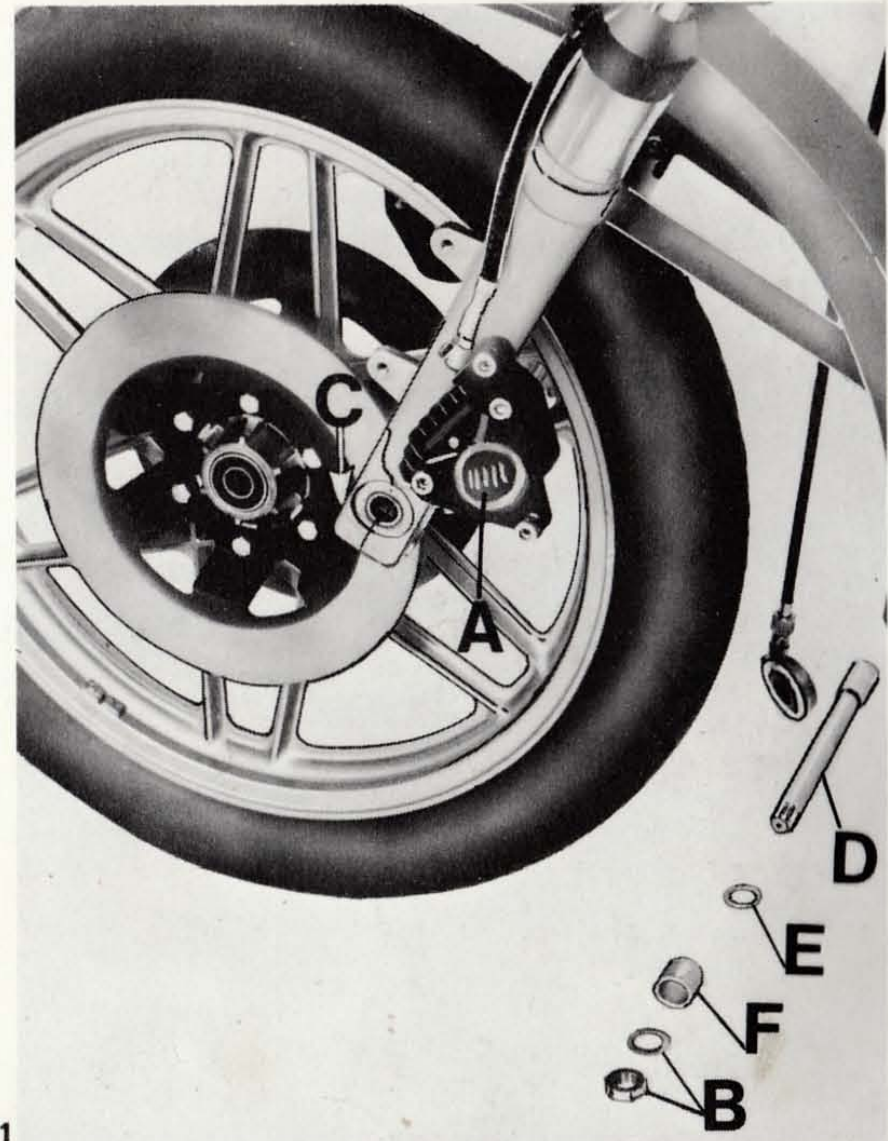



- undo washered nut «A» on wheel spindle, drive box side;
  - undo screw «B» securing wheel spindle to rear swinging arm;
  - take off wheel spindle «D»: drive box, wheel hub and swinging arm;
  - slip off spacer «E»;
  - lean the motorcycle to the right to where the wheel can drop out.
- To re-fit the wheel reverse the dismantling operations.

## Wheel balancing

To improve stability and decrease vibrations at high speeds, the wheels have to be properly balanced.

A good balancing is obtained as follows:

- remove the wheel and set it up on a forked stand;
- spin the wheel lightly several times and watch if it stops always in different positions. If so, the wheel is correctly balanced;

- if one point of the wheel always stops at the bottom, put a suitable weight on the opposite side;
- repeat the operation until the wheel is correctly balanced.

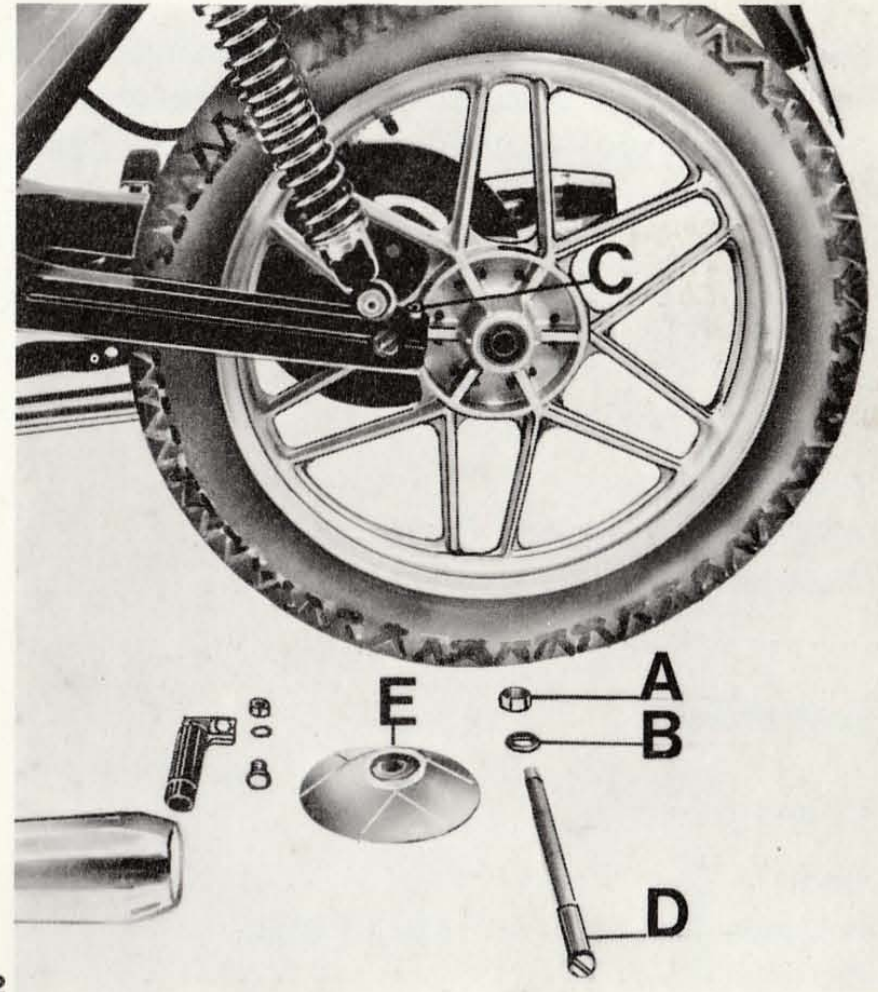



## 34 Tires

The tire condition is of main importance as the stability, riding comfort, and even the rider's safety are largely dependant on the state of the tires.

Never use tires with tread less than 2 mm (0.078"). An incorrect tire pressure can also affect stability and cause rapid deterioration of the tire itself. Correct pressures are:

### Front wheel

- one or two persons

Pirelli	}	2 kg/cm <sup>2</sup> (lb/in <sup>2</sup> 28,5)
Metzeler		
Michelin		

### Rear wheel

- one person

Pirelli	}	2,2 kg/cm <sup>2</sup> (lb/in <sup>2</sup> 31,3)
Metzeler		
Michelin		

- two persons

Pirelli	}	2,4 kg/cm <sup>2</sup> (lb/in <sup>2</sup> 34,2)
Metzeler		
Michelin		

**These data are intended for normal use (touring). In case of constant high speed or motor way riding increase tire pressure 0,2 kg/cm<sup>2</sup> (2,8 lb/in<sup>2</sup>).**

## Tire removal and refitting

These models fit light alloy rims which offer very high mechanical resistance but might suffer damage from a functional and aesthetical aspect if improper tooling is used for the removal and dismantling operations.

Under the circumstances, never use tools that have ribbings or sharp edges on the sides contacting the rim.

The contacting surface of such tooling has to be very wide, smooth and with rounded edges. The use of one of the lubricants available on the market for this purpose will greatly facilitate tire sliding and settling on the rim, preventing also overloads on the tools.

It is also very important for the tire bead to be properly entered into the center rim groove.

Tires that have an arrow on their side will have to be fitted in the following way:

- rear wheel, with arrow turned towards the riding direction;
- front wheel, with arrow turned against the riding direction.

## 36 LUBRICATION AND MAINTENANCE CHART

Monthly (or every 3000 km  
- 2000 mi a.)

- Check electrolyte level in battery (see chapter **Electrical Equipment** «Battery»).

Periodically

- Check tyre pressure (see chapter **Removal of Wheels** «Tyres»).

Every 500 km (300 mi a.)

- Check oil level in the engine crankcase (see chapter **Lubrications** «Engine»).

After the first 500 ÷ 1000 km  
(300 ÷ 600 mi a.)

- Replace the oil in crankcase (see chapter **Lubrications** «Engine»).

- Tighten all nuts and bolts.
- Check rocker clearance (see chapter **Valve Gearing** «Tappet Clearance»).

Every 3000 km (2000 mi a.)

- Replace the oil in crankcase (see chapter **Lubrications** «Engine»).
- Check rocker clearance (see chapter **Valve Gearing** «Tappet Clearance»).
- Check the oil level in the gearbox (see chapter **Lubrications** «Gearbox»).
- Check the oil level in the rear drive box (see chapter **Lubrications** «Rear Drive Box»).

Every 5000 km (3000 mi a.)

- Check the fluid level in the reservoir for braking circuits (see chapter **Maintenance** «Checking the fluid level and changing the brake fluid in reservoir»).



## Every 6000 km (4000 mi a.)

- Replace the oil filter cartridge (see chapter **Lubrications** «Replacing of oil filter cartridge»).

## Every 10.000 km (6000 mi a.)

- Replace the air filter (see chapter **Carburation** «Replacing the air filter»).
- Clean the fuel tank, tap filters and fuel pipes (see chapter **Carburation** «Cleaning the fuel tank, taps, filters and fuel pipes»).
- Replace the oil in the gearbox (see chapter **Lubrications** «Gearbox»).
- Replace the oil in the rear drive box (see chapter **Lubrications** «Rear Drive Box»).
- Clean and smear all battery connections (see chapter **Electrical Equipment** «Battery»).

## Every 15.000 km (8000 mi a.)

- Replace the brake fluid in front and rear braking circuits (see chapter **Maintenance** «Checking

the fluid level and changing the brake fluid in braking circuits»).

37

## Every 20.000 km (12.000 mi a.)

All checkings hereunder described must be carried out by our dealers:

- Check the condition of the wheel bearings.
- Check there is sufficient grease for steering caps and balls (see chapter **Lubrications** «Other lubrications»).
- Replace the oil in fork covers (see chapter **Lubrications** «Front Fork»).
- Clean the commutators of generator and starter motor using a clean rag slightly moistened with petrol.

## 38 LUBRICATIONS

### Engine (Pict. 23)

#### Checking the oil level:

- Every 500 km (300 mi a.) check the oil level in the sump. (A correct level is nearly at the maximum mark on the filler dipstick «A»).
- Should the level be lower, top up with oil of same type and density.

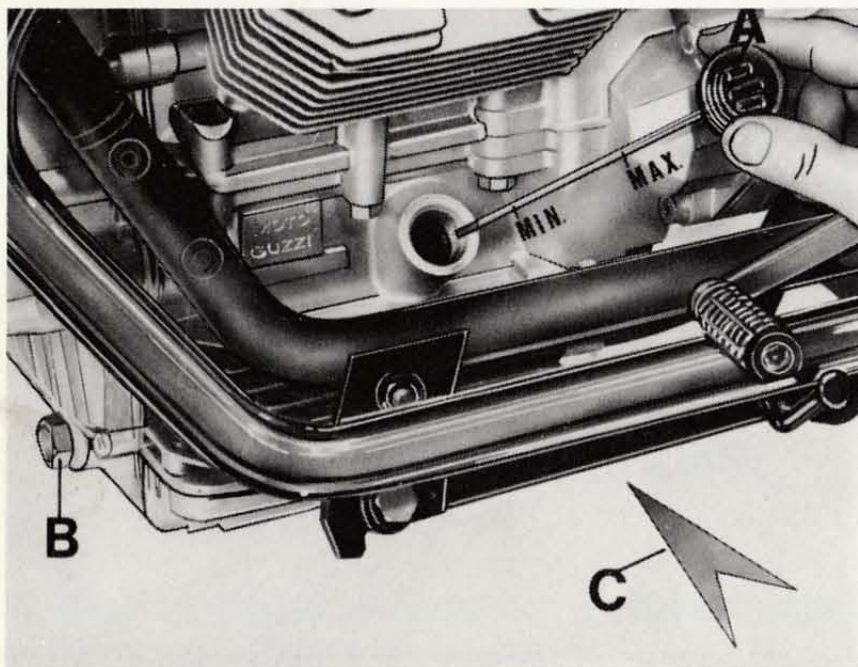

Let the engine idle for a few minutes before checking; oil filler dipstick «A» must be screwed down fully.

#### Changing the oil:

- After the first 500 ÷ 1000 km and later on every 3000 km (2000 mi a.) change the crank-case oil.
  - The oil has to be replaced when the engine is warm. Remember to allow all the old oil to drain before introducing fresh oil.
- «A» Oil filler cap with dipstick.  
«B» Oil drain plug, front.  
«C» Oil drain plug, rear.
- Q.ty required: 2,250 l (5.8 US pints - 4<sup>1</sup>/<sub>2</sub> Imp. pints) «Agip Sint 2000» SAE10 W/50.

#### Replacement of filter cartridge (Pict. 24):

After the first 500 ÷ (first oil change) and later on every 6000 km (4000 mi) or so, replace the filter cartridge proceeding as follows:



- Undo drain plugs «B» and «C» and oil filler cap. «A», Pict. 23.
- Let the oil fully drain from sump «C».

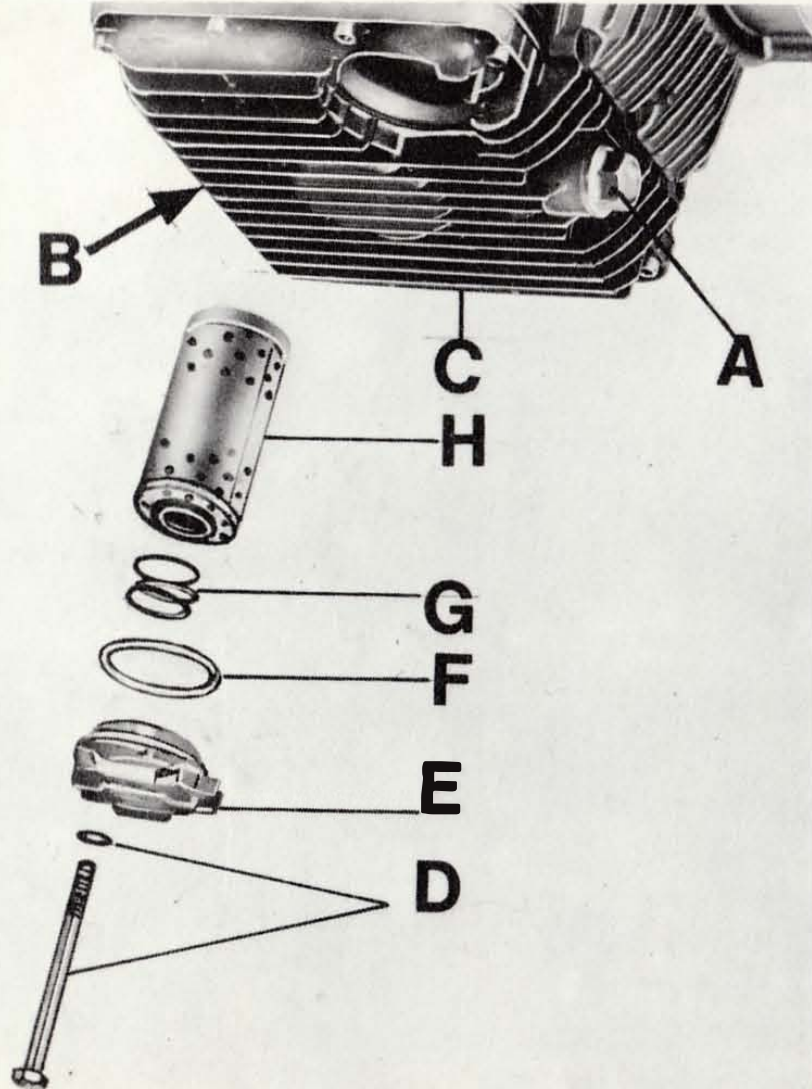

- Undo cartridge securing screw «D», and remove the group consisting of: cover «E», gasket «F», spring «G», cartridge «H».

- Replace the cartridge «H» and if necessary the gasket «F» on cover «E». Re-fit the whole group by reversing the removal sequence and fill with the required oil quantity before screwing in the oil filler cap.

*This operation is best carried on by our dealers.*

#### **Washing the wire gauze filter and oil sump:**

After the first 500 ÷ (first change of oil and filter cartridge) and later on every 15.000 (9000 mi a.), it is advisable to remove the oil sump from the crankcase, to take out the wire gauze filter and wash both in a petrol bath, then dry off with compressed air. Replace also the gasket between sump and crankcase before mounting the sump.

*This maintenance is best done by our dealers.*



## 40 Gear box (Pict. 25)

### Checking the oil level:

Every 3000 km (2000 mi a.) check that the oil level is nearly at plug input hole and level «A». In case of incorrect level, top up with oil of same type and density.

### Changing the oil:

Every 10.000 km (6000 mi a.) or so, replace the oil in the gearbox.

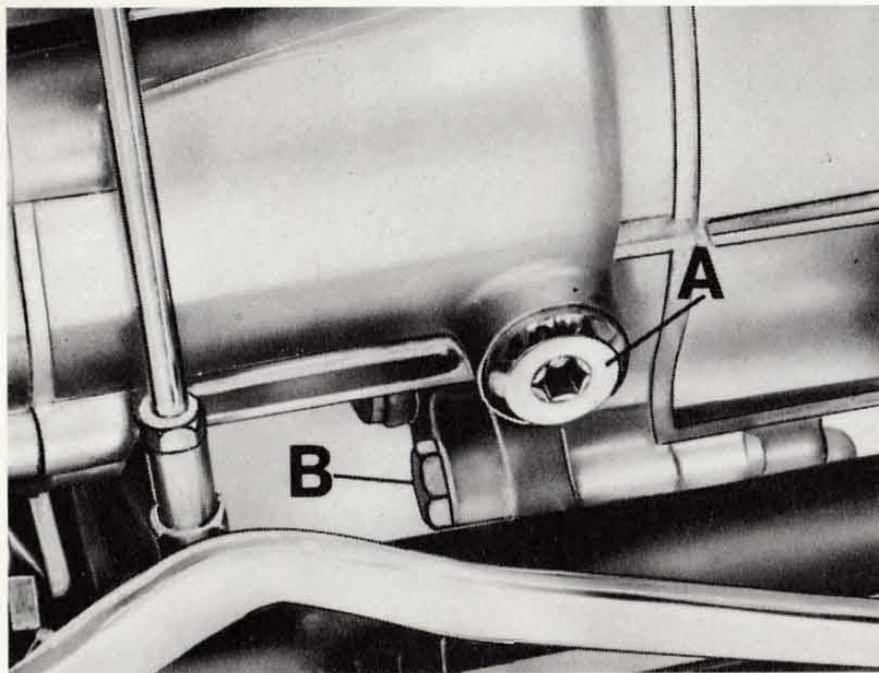

25

This operation has to be carried out when the oil is still warm and easy to drain. Remember to drain all the old oil before introducing fresh oil.

«A» Oil filler cap.

«B» Oil drain plug.

Q.ty required: 1 l (2.11 US pints - 1.75 Imp pints) oil «Agip F.1 Rotra MP SAE 140».

## Rear drive box

### Checking the oil level:

Every 3000 kms (abt. 2000 miles) check that the oil level is skimming the input plug hole and level «A». If lower, top up with oil of same type and density.

### Changing the oil:

Every 10.000 kms (abt. 6000 miles) change the oil in the rear drive box.

This operation should be done on a warm engine when the oil is fluid and so more easily drained. Be sure to drain all the old oil before introducing fresh oil.

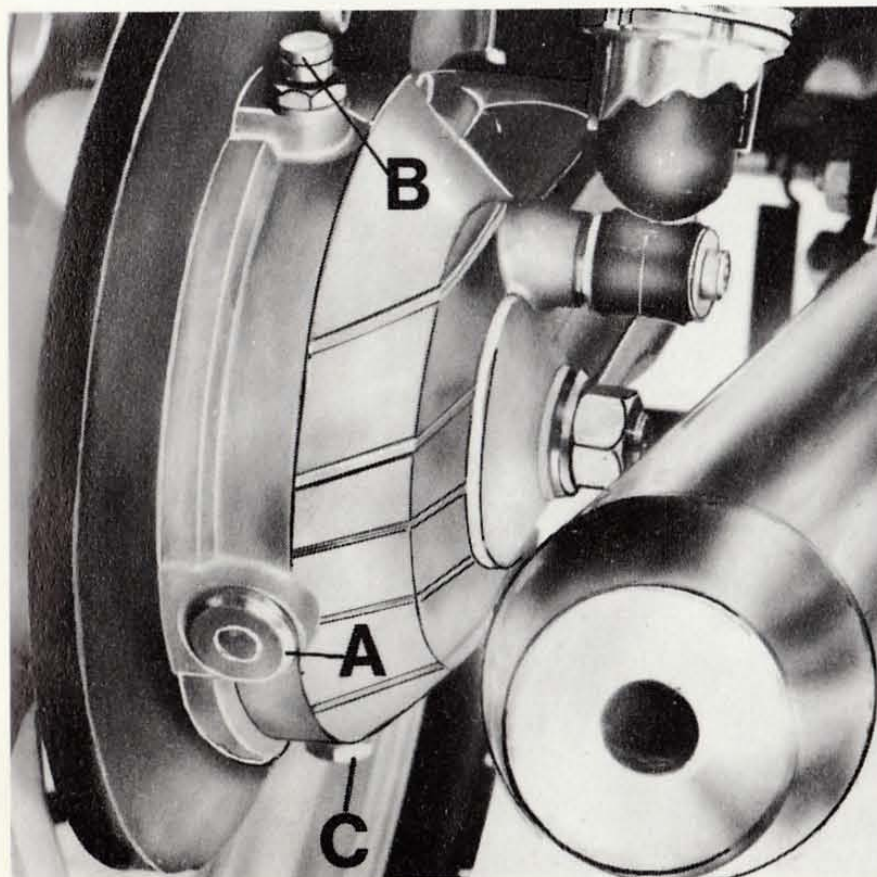

26

41

«A» Oil filler cap.

«B» Oil vent plug.

«C» Oil drain plug.

Q.ty required: 0.170 l of which 0.160 l (10 cu. in.) «Agip F.1 Rotra MP SAE 140» and 0.010 l (0.6 cu. in.) «Agip Rocol ASO/R».

## Front fork (Pict. 27)

To replace the lubricating oil in fork legs proceed as follows:

- Undo the oil drain plug with gasket «A».
- Undo the oil filling Allen screws «B».
- Before introducing fresh oil, let the old oil drain fully.

«A» Oil drain plug with gasket.

«B» Oil filling screw.

Q.ty required: 0.070 l (4 cu. in.) each leg «Agip F.1 ATF Dexron».



## 42 Other lubrications

For lubricating:

- Steering caps and balls.

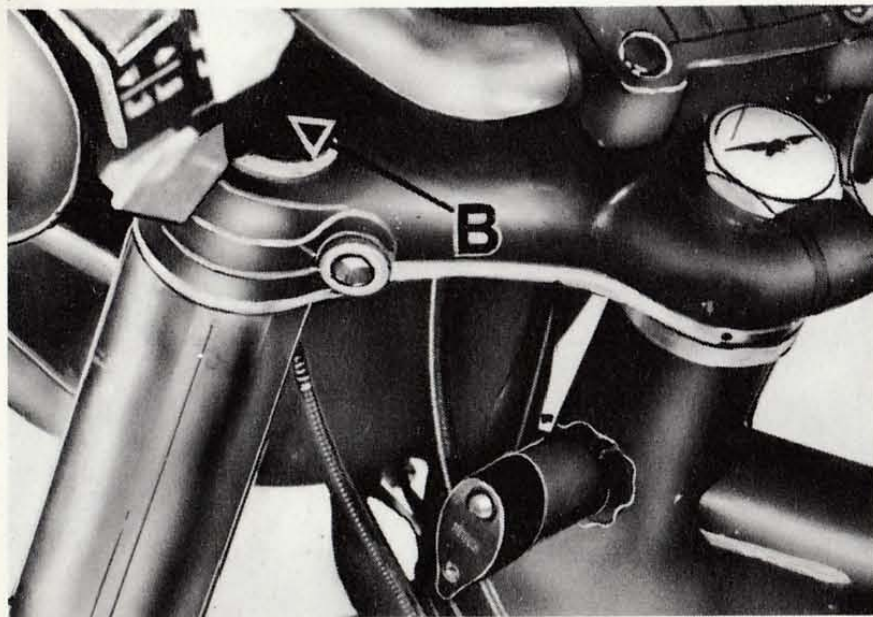

- Rear swing arm bearings.
- Right front brake cable.
- Tacho transmission gear.

Use «Agip F.1 Grease 30».

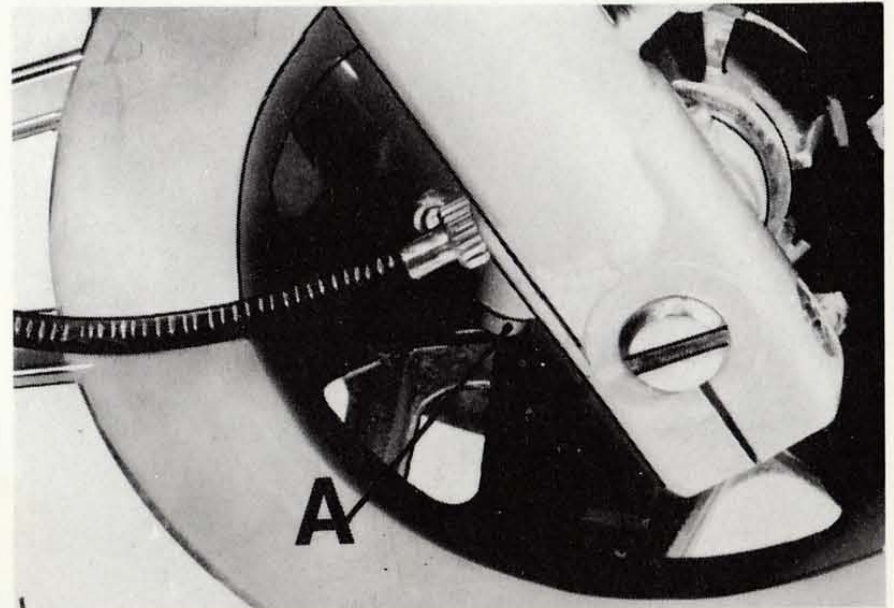



# CARBURATION

## Carburetors (Pict. 28)

N. 2 carburetors Dell'Orto «VHB 24 FD (right)»  
«VHB 24 FS (left)».

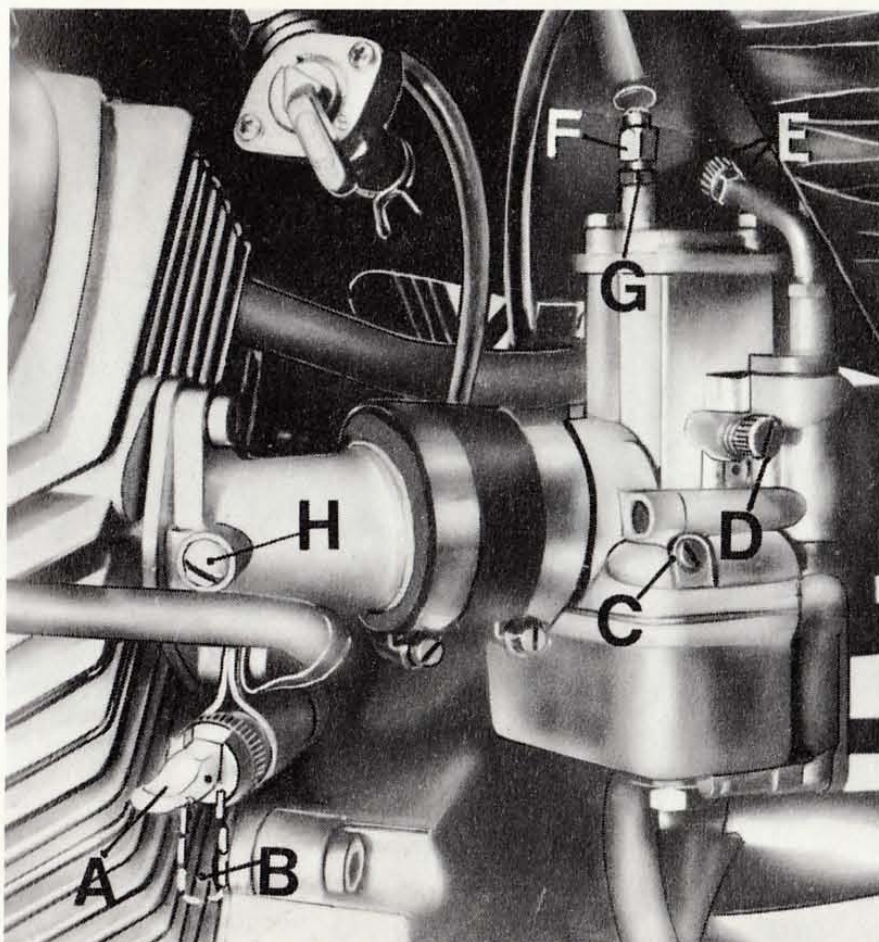

### Controls:

- Throttle control grip, on the R/H side of the handlebar.
- Starter control lever for starting a **cold engine**, on the L/H side of the motorcycle under a screw securing intake tube to engine head.

### Positions:

- «A» Starting position for a **cold engine**.
- «B» Riding position.

*Note - When the starter lever is in riding position «B» ensure that there is a clearance of about 3 mm between starter control cable ends and adjuster screw «E».*

#### 44 Carburettor standard setting:

Choke	∅ mm 24
Throttle	40
Atomizer	260 AH
Main jet	105
Idling jet	40
Starter jet	60
Needle	E 2 (2nd. notch)
Floater	gr 14
Opening of idling adjuster screw	1 turn and a half

#### Adjusting carburation and idling speed (Pict. 28)

If a suitable vacuumeter is unavailable, this adjustment is made as follows:

- 1 Run the engine up to its normal riding temperature.
- 2 Screw idling screws «C» fully in and then screw them out one and a half turn.

3 Place your hands at each exhaust pipe end to make sure pressure is even. If not, act on screw «D» of one carburettor until both exhaust pressures are the same (since the idling speed has to be kept at about 1000-1200 rpm, it may be necessary to screw in the carburettor screw of the cylinder giving a lower pressure or to screw out the screw of the cylinder giving a higher pressure).

4 Operating on screw «C» adjust each cylinder to the point where carburation is best (that is the point where the revs tend to increase slightly, then re-set idling speed as described at 3).

5 Disconnect one plug lead at the time and check that in each instance the engine stops after firing the same number of strokes. If not, proceed as follows:

- Undo carburettor screw «D» of the cylinder firing too much or screw in the carburettor screw of the cylinder firing less.

6 Adjust idling speed to 1000-1200 rpm. by screwing in or out both screws «D» by the same amount.



7 With the twist grip fully closed, check that the clearance between the cable terminal and adjusting screws is  $1 \div 1.5$  mm ( $0.039 \div 0.059$ "') for both carburetors. If not, loosen nuts «G» and screw in or out cable adjusters «F», finally re-tightening nuts «G».

8 Check synchronization of the throttle slides opening. Proceed as follows: with the assistance of a second person to slowly turn the twist grip control, check with your hands if the pressure increase at each exhaust pipe end is synchronous. If not, adjust carburation of the cylinder in

advance by screwing in cable adjuster «F» and loosened conternut «G» until the pressure is the same for both exhaust pipes.

### Adjusting carburation by means of a vacuumeter

For a correct carburation adjustment, we recommend to **have this operation done in any of our dealer's shops by means of a vacuumeter.**

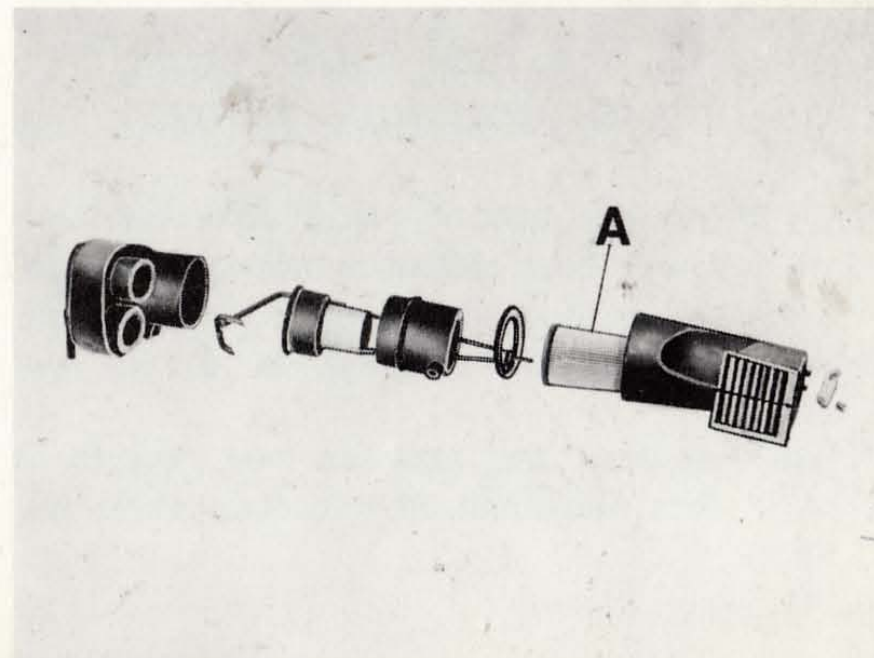
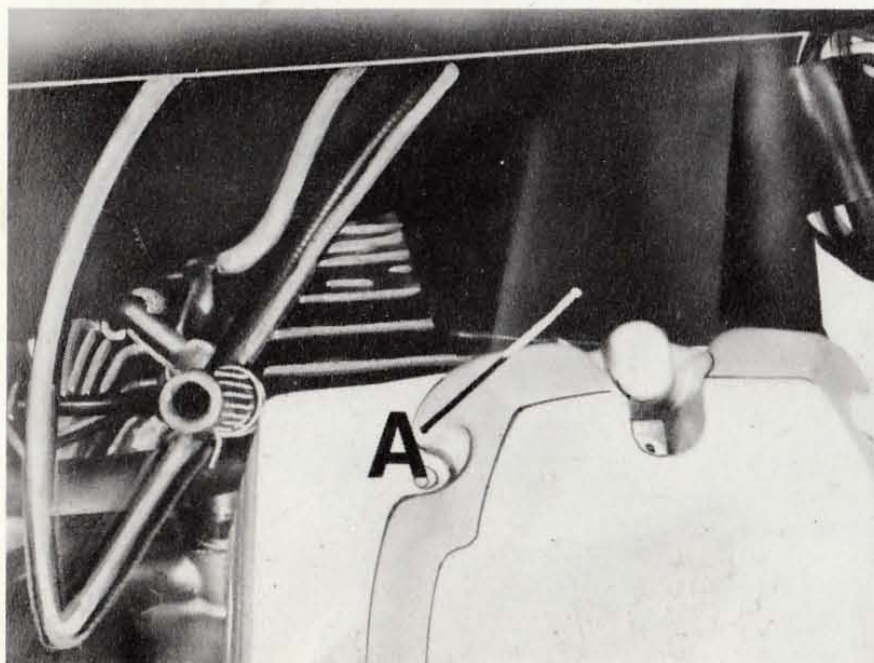



## 46 Replacing the air filter (Pict. 29)

Every 10.000 kms (6000 miles) or more frequently in case of riding on dusty roads, it is advisable to replace the air filter «A».

This filter is accomodated in a suitable housing over the power unit together with the oil breather assembly.

**The replacement of the filter cartridge is best done in one of our dealer shops.**

## Cleaning the fuel tank, fuel taps, filters, and fuel pipes

Every 10.000 kms (6000 miles) or whenever there is an irregular flow of fuel to the carburettors, it is necessary to clean the tank, taps, both filters on the taps and carburettors, and all fuel lines.

Filters, fuel lines, and taps are best cleaned in a petrol bath, and dried off with compressed air.

## VALVE GEARING

### Adjusting tappet play (Pict. 30)

After the first 500 ÷ 1000 kms (300 ÷ 600 miles) and later on every 3000 kms (1900 miles) or any time valve operation is too noisy, check tappet play.

Do this control on a **cold engine** with piston at TDC in the compression stroke (valves closed).

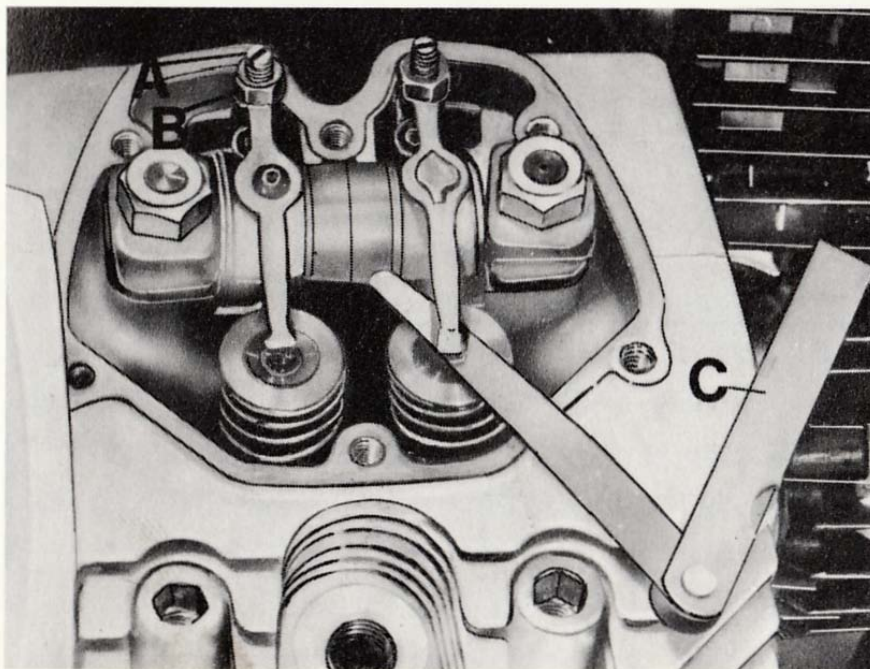

After removing the the cylinder head cover, operate as follows:

- 1 Slacken nut «A».
- 2 Screw in or out adjusting screw «B» until the following clearances are obtained:

- inlet valve 0.10 mm (.0039'');
- exhaust valve 0.15 mm (.0059'').

This clearance is checked using feeler gauge «C».

If this clearance is more there will be noisy valve operation, if less the valves may not close fully causing inconveniences such as:

- loss of compression;
- overheating of engine;
- burning of valves etc....

# 48 IGNITION

The electronic ignition device requires practically no maintenance as it consists of part not subject to mechanical wear.

Accordingly, no periodical servicing is required, except for possible faults of the electronic com-

ponents (electronic boxes and pickups) or in the electrical connections.

If an emergency arises, see the instructions in the following chapter for a **Manual** adjustment of ignition timing.

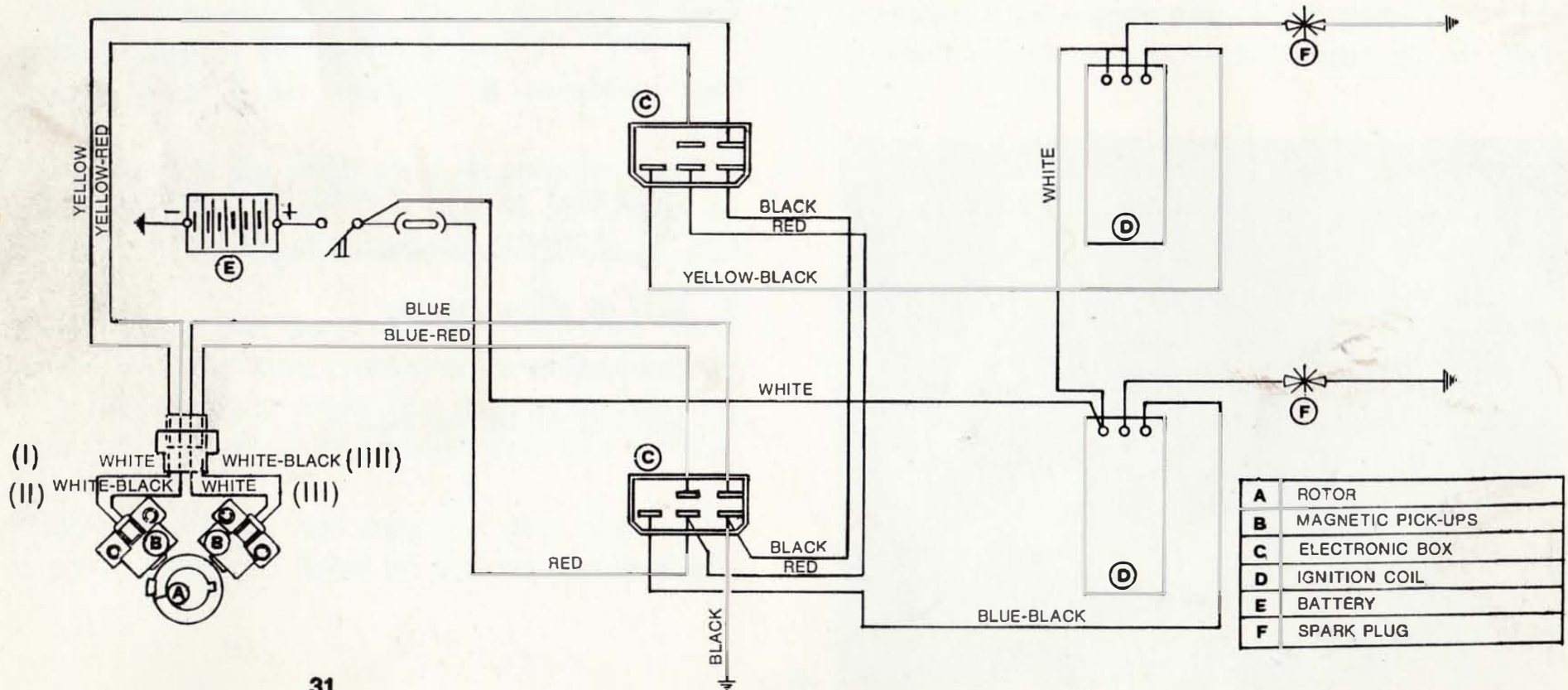



## Manual adjustment of ignition timing (Pict. 31, 32, 33)

Proceed as follows:

- 1 Undo the screws and remove the generator cover.
- 2 Remove the rubber cap from inspection hole «A» (Pict. 33).
- 3 Undo the rotor securing screw, fit a proper pin into the crankshaft hole, screw in the screw again and take off the rotor.
- 4 Undo the screws and remove the pick-ups cover.
- 5 Revolve the crankshaft until mark «D» on the flywheel is in the middle of the hole (looking through inspection slot «A») with right piston at TDC (see «B» in Pict. 33).
- 6 Ensure mark «E» on the pickup is in line with mark «H» on the crankshaft control sleeve. Undo screws «C» and suitably move the pickup.
- 7 Rotate the crankshaft counter to running rotation checking that the center-line of rotor block «E» is aligned with the mark on pick-up «F».
- 8 Fit feeler gauge «B» between block «E» and pick-up metal ends «G» ensuring there is the

recommended clearance «A» of  $0.15 \div 0.20$  mm (.0059 - .0079") (Pict. 32). In case of incorrect clearance adjust it by undoing screws «C» and shifting pick-up «D».

- 9 Repeat checkings under points 5 and 6.
- 10 The proceeding to checking the ignition timing for left cylinder is the same as for the right cylinder except that:

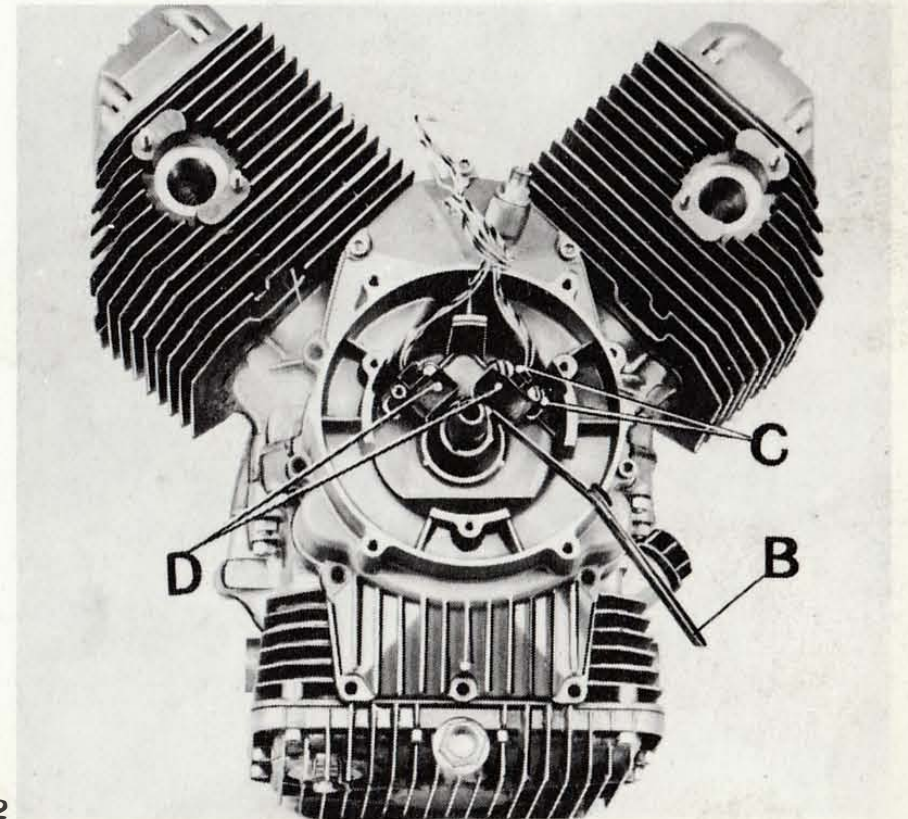

- 50 — The crankshaft is rotated until the mark «S» on the flywheel comes to the middle of the hole (looking through inspection hole «A»).
- Left piston at T.D.C. - see «B» Pict. 33.
- Ensure the mark «F» on the pick-up is properly aligned with the mark «H» on the rotor.

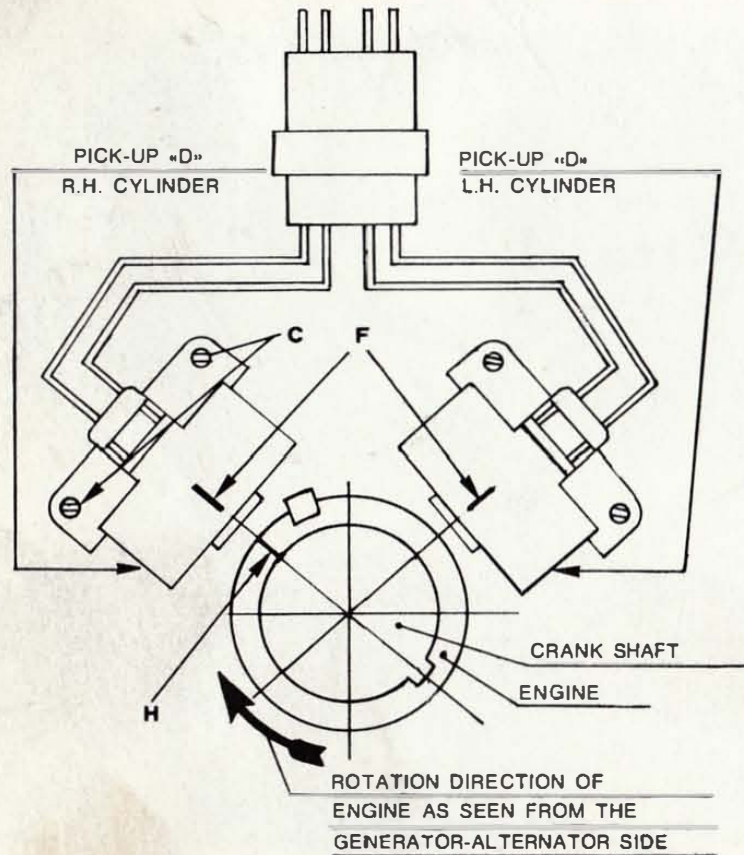

Check pick-up clearance as indicated under points 7 and 8.

*Note - In case control sleeve «E» is removed from the crankshaft, it will be necessary when refitting to ensure the side with countersinking is fitted inwards while the mark «H» will have to be visible from the outside. The left pickup has a yellow mark. The right pickup has a blue mark.*

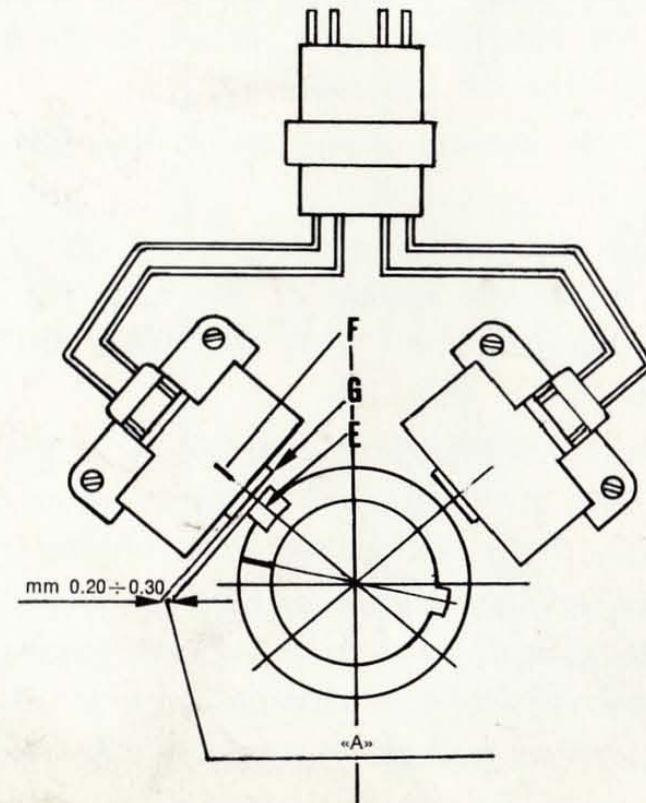



## Checking the ignition timing by means of a stroboscope lamp (Pict. 33)

Main purpose of this control is to ensure proper operation of the electronic box and especially to check that it times the max automatic advance correctly.

### Checking timing of the right cylinder

- Remove the rubber cover from the inspection slot «A» on the R/H side of the gearbox.
- Evidence max advance marks («1» and «2») on the flywheels for both cylinders, by means of light paint.
- Connect the stroboscope lamp cable to the right cylinder spark plug.
- Connect the stroboscope lamp clamped cables to a battery (+ to +; — to —).
- After checking electrical connections, start the engine and warm it up to its running tem-

perature, then gradually increase the revs up to 6000 rpm. (watch rev. counter on instruments panel).

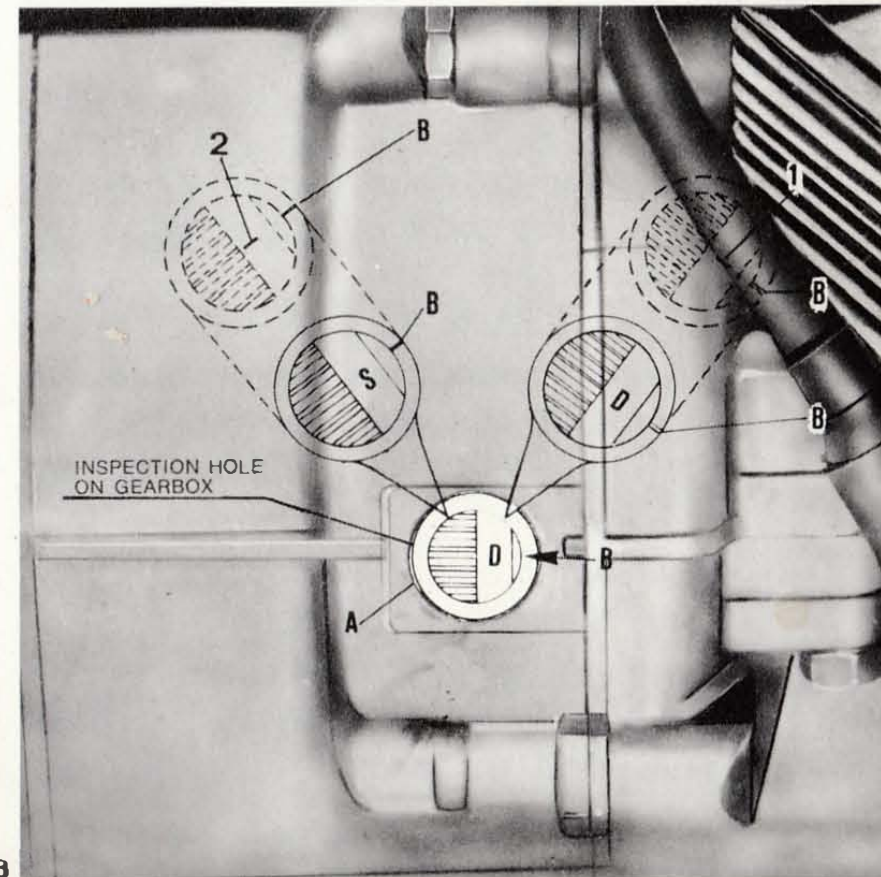



52 *At this stage direct the stroboscope lamp light to inspection hole «A» and ensure that mark «1» on the flywheel is in the middle of the inspection hole itself (see «B»). If this does not occur, it will be necessary to check the efficiency of the electronic box.*

## Checking timing of the left cylinder

Proceed exactly as for the right cylinder except that the strobe lamp cable is connected to the left cylinder spark plug.

With the engine running at 5000 ÷ 5500 rpm., mark «2» on the flywheel should show up at the center of inspection slot «B».

## Ignition data

Maximum advance: 35° at 5000-5500 rpm.

Clearance «A» between rotor block and the pick-up metal ends: 0.15 ÷ 0.20 (.0059-.0079").

*Ignition checkings are best carried out by our dealers.*

## Spark plugs

Spark plugs to be used are: Marelli CW 9 PL - Bosch W 260 T 30 - Lodge 2 HLN. Points gap: 0.6 mm (0.023 in.). In re-fitting the spark plugs ensure they are properly started by hand for a few turns completing the operation by means of the plug wrench in the tool kit.

For all events, the plugs have to be replaced every 10.000 km (6000 mi a.) even if they still appear to be in good conditions.

# ELECTRICAL EQUIPMENT

The electrical equipment includes the following:

- Battery.
- Starter motor.
- Generator-Alternator.
- Electronic box.
- Pick-up.
- Rotor (Block on the control sleeve).
- Ignition coils.
- Rectifier.
- Regulator.
- Terminal block with fuses (n. 4 - 16 A).
- Flashing relay.
- Starting relay.
- Headlight.
- Tail light.
- Turn signals.
- Key switch.
- Lighting switches.
- Switches for: turn signals, horn, flashing
- Engine starting device.
- Horn.
- Warning lights for: neutral position (orange) - parking light «town driving» (green) - oil pres-

sure (red) - high beam (blue) - generator warning (red).

## Battery

Battery is a 12 V type with a capacity of 20 AH and is directly charged by the generator.

Access to the battery is made possible by following operations:

- lift the saddle by means of lever «A» (Pict. 13);
- unhook the rubber band «A» and detach electric wires «B» and «C» (Pict. 34) from the battery;
- take out the battery.

## Putting new batteries into service

- 1 Remove battery from motorcycle.



- 54 2 After removing the caps fill in each battery cell sulphuric acid, battery type, with specific gravity  $1.26 = 30^\circ$  Bé and temperature not lower than  $15^\circ\text{C}$  until the acid level covers the partitions or the splash shield.

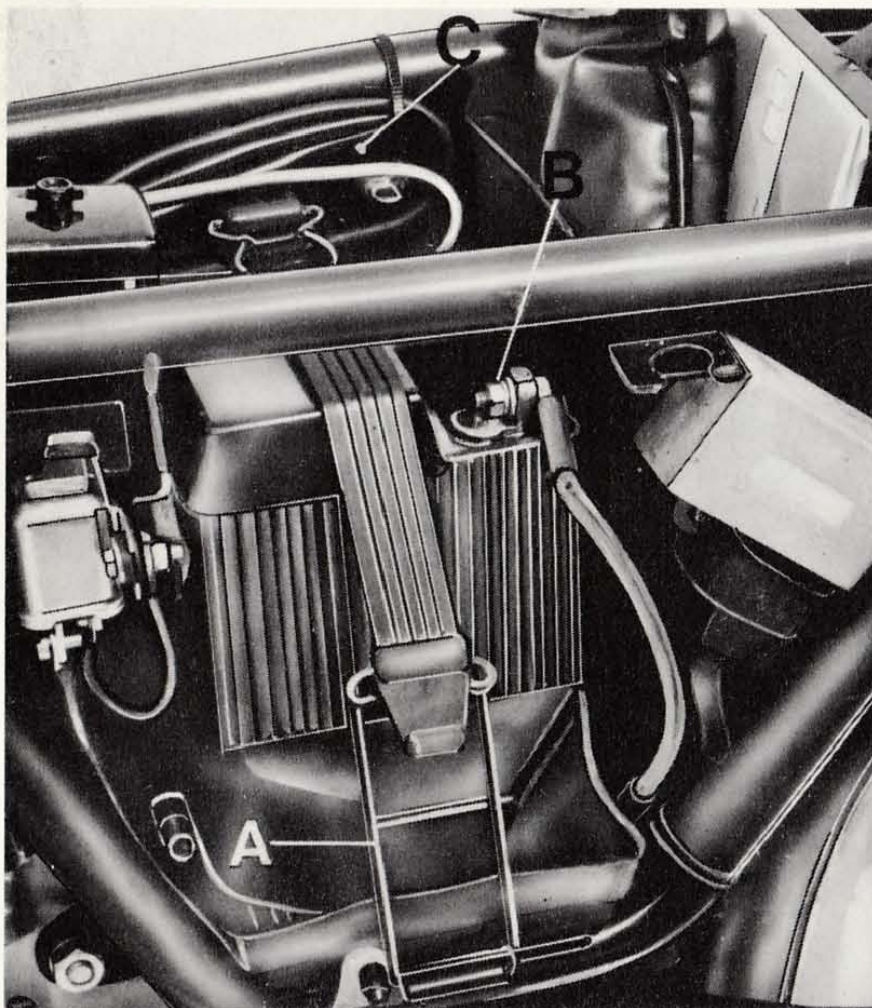

- 3 Let the battery at rest for two hours.
- 4 Charge the battery with intensity equal to about  $1/10$  of its capacity until tension reaches about  $2,7\text{ V}$  per cell (that's  $8$  or  $16\text{ V}$  for  $3$  or  $6$  cell batteries). The acid gravity is about  $1.27 = 31^\circ$  Bé and these values should be maintained for at least  $3$  hour charging. Normally  $6 \div 8$  charging hours are sufficient.
- 5 After charging, top up, close and carefully clean.

## Servicing the battery under service conditions

- 1 The electrolyte level should always cover the separators. To top up use distilled water. Never add sulphuric acid.
- 2 If too frequent water additions are required, have the electrical system checked over as the battery works in an overcharged condition and will deteriorate quickly.
- 3 If the battery discharges quickly, the electrical system should also be checked over.



**4** In case new or second hand batteries are left unused for fairly long periods of time, it is a good rule to re-charge them every month.

**5** Always keep the battery terminals spotless, clean and smeared with neutral vaseline.

**6** Always keep the top battery cover dry, avoiding overflows of electrolyte which will reduce insulation and corrode the battery bracket.

*Note - If batteries are on service in tropical climates (average temperature higher than 33°C) it is recommended to reduce acid gravity to 1,230.*

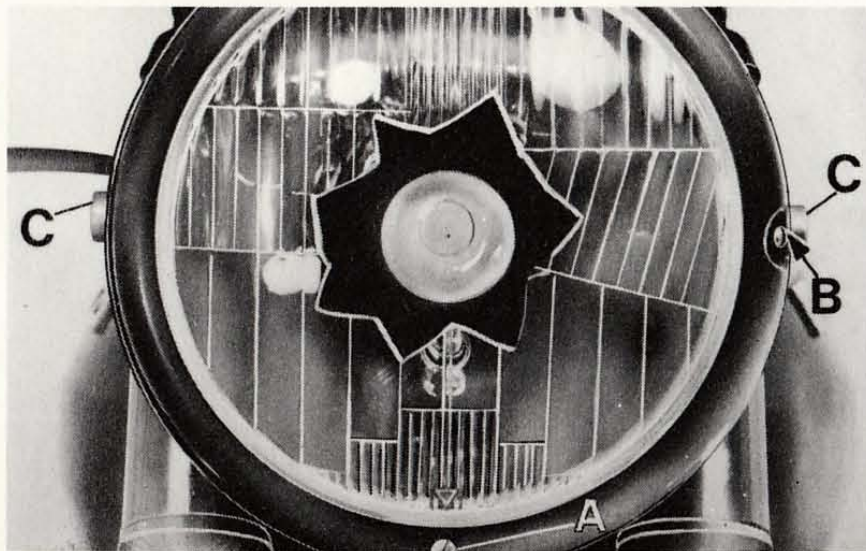

35

## Replacement of light bulbs

55

### Headlamp (Pict. 35)

Undo bottom screw «A», withdraw the beam unit, take off the lamp holder, and replace the bulb (Sealed beam unit for USA).

### Tail light (Pict. 36)

Undo screws «D» securing reflector to tail light, push bulbs inwards turning them to the left and slip them off.

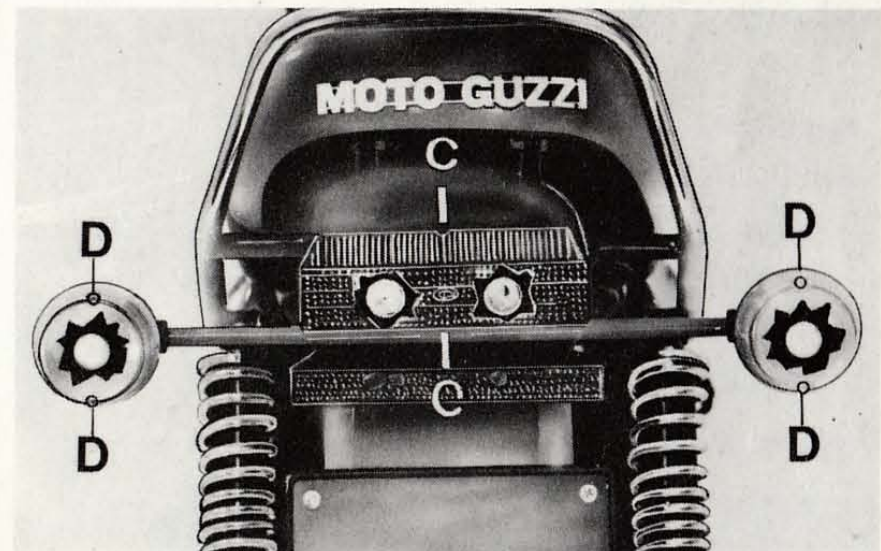

## 56 Turn signals (Pict. 36)

Undo the screws «E» securing reflectors to turn signal lights, push bulbs inwards turning them to the left and slip them off.

*In re-fitting the reflectors, screw in uniformly and do not lock too much to prevent breaking.*

### **Instrument panel, Tachometer and rev. counter:**

- Slip off bulb sockets and replace bulbs.

## Bulbs (12 V)

Headlight:

Tail light:

— high and low beam	45/40	W
— parking light	3	W
— number plate lighting		
parking & stop light	5/21	W
Turn signals:	21	W
— warning lights	1,2	W
— instrument lighting	3	W

## Headlight beam adjusting (Pict. 35)

For a safe riding and not to trouble crossing riders, the headlight beam has always to be set a correct height.

Horizontal setting is adjusted by screw «A» while vertical setting is adjusted by undoing screws «C» and shifting the headlight by hand up or down until the correct height is reached.

The centre of the high beam must not be higher than 0.86 m measured at 3 m distance with motorcycle not on the stand and rider on saddle.

**KEY TO WIRING DIAGRAM**



- 1 - Tachometer (bulb 3 W - 12 V)
- 2 - Rev. counter (bulb 3 W - 12 V)
- 3 - High beam warning light (bulb 1,2 W - «h» blue)
- 4 - Oil pressure warning light (bulb 1,2 W - 12 V «Oil» red)
- 5 - Neutral warning light (bulb 1,2 W - 12 V «n» orange)
- 6 - Parking warning light (bulb 1,2 W - 12 V «l» green)
- 7 - Generator warning light (bulb 1,2 W - 12 V «Gen» red)
- 8 - Low beam } bulb 40/45 W - 12 V
- 9 - High beam }
- 10 - Front parking light (bulb 3 W - 12 V)
- 11 - Right front turn signal (bulb 21 W - 12 V)
- 12 - Left front turn signal (bulb 21 W - 12 V)
- 13 - 3-way connector
- 14 - 12-way connector
- 15 - Light and engine starting switch (3 positions)
- 16 - Control device for: turn signals, horn and flashing light, lighting
- 17 - Control device for engine starting and stopping
- 18 - Horn
- 19 - Magnetic pick-ups
- 20 - 4-way connector AMP
- 21 - Rotor
- 22 - Oil pressure switch
- 23 - Neutral position switch
- 24 - Flashing light relay
- 25 - Rectifier
- 26 - Alternator
- 27 - Regulator
- 28 - Battery
- 29 - Rear brake switch
- 30 - Front brake switch
- 31 - Electronic box, left cylinder
- 32 - Electronic box, right cylinder
- 33 - Turn signal flasher unit
- 34 - Ignition coil
- 35 - Terminal block with fuses (16 A fuses)
- 36 - Starting relay
- 37 - Starting motor
- 38 - Right rear turn signal (bulb 21 W - 12 V)
- 39 - Left rear turn signal (bulb 21 W - 12 V)
- 40 - Rear stop light
- 41 - Number plate lighting and rear parking light } n. 2 bulbs 21/5 W - 12 V
- 42 - Tail light

### Fuses

- N. 1: Stop light (rear brake) - Turn Signals.
- N. 2: Starting relay - Stop light (front brake) - Flashing light relay - Horn.
- N. 3: Warning lights (gen-oil-n) - High beam and warning - Low beam.
- N. 4: Parking light (front and rear) - Instrument lighting - Warning light «1».

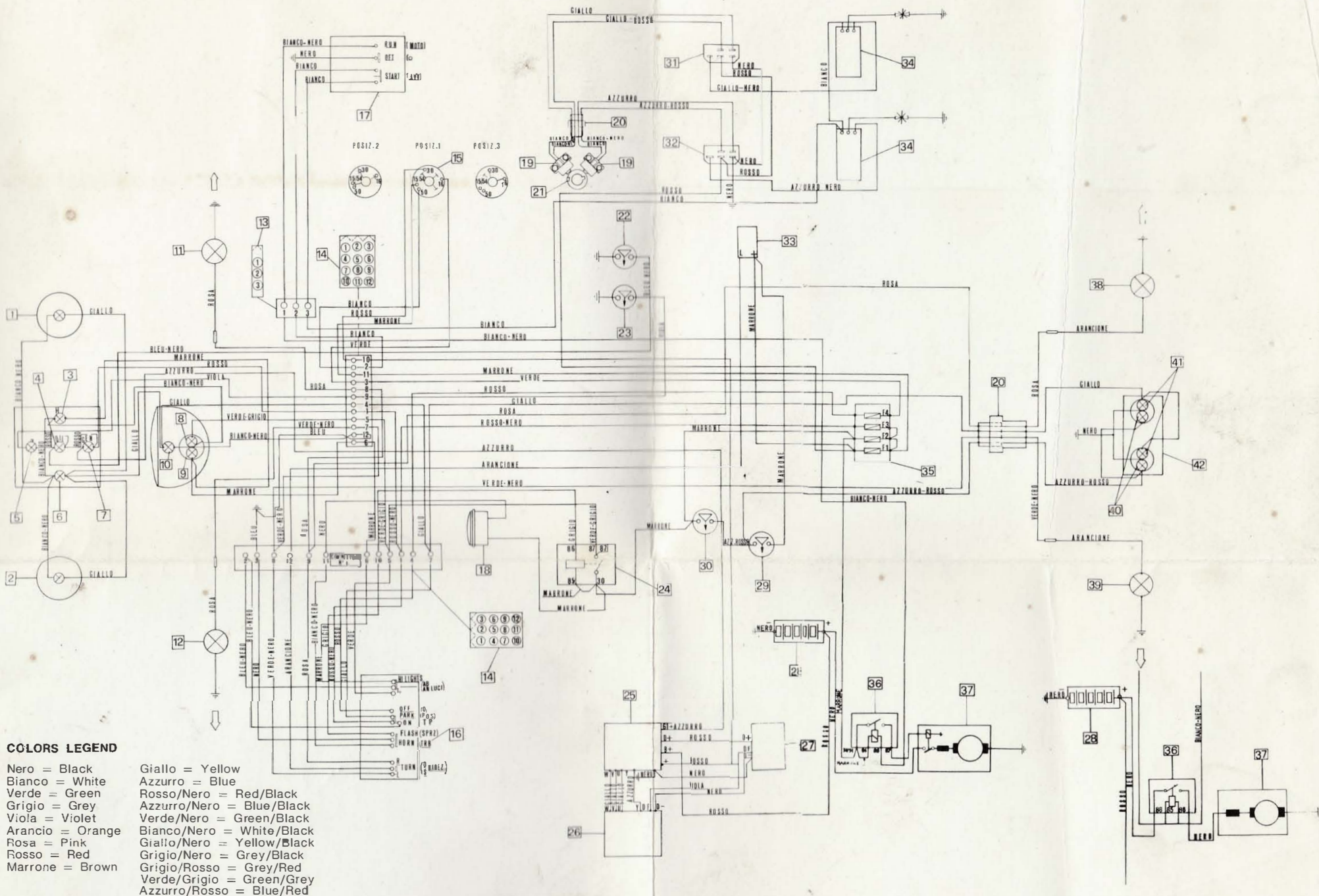

**COLORS LEGEND**

- Nero = Black
- Bianco = White
- Verde = Green
- Grigio = Grey
- Viola = Violet
- Arancio = Orange
- Rosa = Pink
- Rosso = Red
- Marrone = Brown

- Giallo = Yellow
- Azzurro = Blue
- Rosso/Nero = Red/Black
- Azzurro/Nero = Blue/Black
- Verde/Nero = Green/Black
- Bianco/Nero = White/Black
- Giallo/Nero = Yellow/Black
- Grigio/Nero = Grey/Black
- Grigio/Rosso = Grey/Red
- Verde/Grigio = Green/Grey
- Azzurro/Rosso = Blue/Red



SEIMM MOTO GUZZI S. p. A. Mandello del Lario

Registro Società Lecco N. 2220

