

850-T3



**owner's manual**



*Dear rider,*

*First of all we wish to thank you for choosing this motorcycle of our production.*

*By following the instructions outlined in this manual you will ensure your bike a long and troublefree life.*

*Before riding, please read thoroughly this manual in order to know your motorcycle's features and how to operate it safely.*

*All major checking and overhaul jobs are best carried out by our dealers who have the necessary facilities to quickly and competently repair your Moto Guzzi.*

*Repairs or adjustments by other than a Guzzi dealer during the warranty period could invalidate the warranty right.*

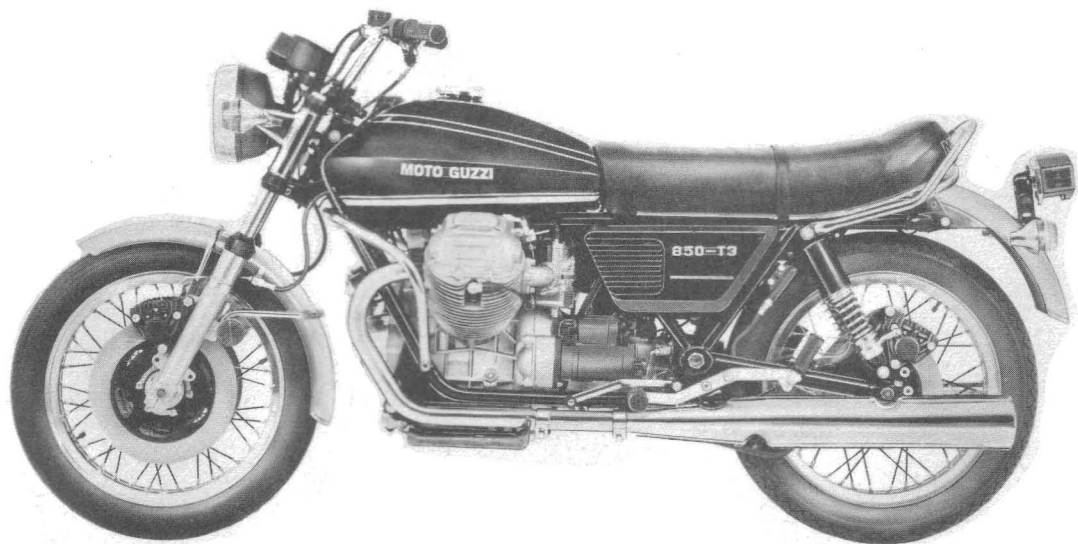



# INDEX

- 4 Main features
- 10 Controls and accessories
- 12 Identification data
- 13 Instruments and controls
- 20 Riding Instructions
- 21 Running in
- 23 Maintenance
- 29 Removal of wheels
- 32 Lubrication and maintenance chart
- 36 Lubrications
- 40 Carburation
- 43 Valve gearing
- 44 Ignition
- 48 Electrical equipment
- 50 LIGHTS (Europe model)
- 52 Wiring Diagram (Europe model)
- 54 LIGHTS (U.S.A. model)
- 57 Wiring Diagram (U.S.A. model)

## 4 MAIN FEATURES

2-cylinder 4-stroke  
Cylinder disposition «V» 90°  
Bore mm 83  
Stroke mm 78  
Displacement cc 844  
Compression ratio 9,5  
Output HP 68,5 SAE at 7.000 r.p.m.

### **Valve gear**

O.H.V. push rod operated.

### **Carburation**

2 Dell'Orto carburetors type VHB 30 CD (right), VHB 30 CS (left).

### **Lubrification**

Pressure, by gear pump.  
Normal lubrication pressure 3,8 ÷ 4,2 kg/sqcm (controlled by relief-valve).  
Electrically controlled oil pressure gauge.  
Wire gauze and cartridge oil filters.

### **Generator**

Front (14 V - 20 A) on the mainshaft.

### **Ignition**

By battery, with double contact breaker and automatic advance.

Ignition data:

Initial advance (fixed) 2°

Automatic advance 31°

Full advance 33°

Contact breaker gap mm  $0,37 \div 0,43$

Spark plugs:

Marelli CW 7 L; BOSCH W 225; AC - 44 XL

Plug points gap mm 0,6

2 ignition coils.

### **Starting**

Electric starter (12 V - 0,7 HP) with electromagnetic ratchet control. Ring gear bolted on flywheel. Starter button, (START) right on the handlebar.

## **Transmission**

### **Clutch**

Dry type, multiplates, flywheel driven. Lever controlled from handlebar (left).

### **Primary drive**

via the gearbox.

Ratio : 1:1,235 ( $Z = 17/21$ ).

### **Gear box**

Five speeds, frontal engagement, constant mesh gears. Cush drive incorporated.

Pedal controlled from left side of the motorcycle  
Ratios:

low gear 1 : 2 ( $Z = 14/28$ )

2nd gear 1 : 1,388 ( $Z = 18/25$ )

2rd gear 1 : 1,047 ( $Z = 21/22$ )

4th. gear 1 : 0,869 ( $Z = 23/20$ )

top gear 1 : 0,750 ( $Z = 28/21$ )

### **Secondary drive**

cardan shaft (bevel gear set).-

Ratio: 1 : 4,714 ( $Z = 7/33$ ).

Overall gear ratios (engine/wheel):

low gear 1 : 11,643

2nd gear 1 : 8,080

3rd. gear 1 : 6,095

4th gear 1 : 5,059

top gear 1 : 4,366

### **Frame**

Duplex cradle, tubular structure.

### **Suspension**

Telescopic front fork incorporating sealed hydraulic dampers.

Rear swingin fork with externally adjustable springs.

**Wheels**

Spoked rims, WM 3/2,15 x 18 front and rear.

7

**Tires**

Front 3,50 H - 18 H or 100/90 H - 18 H.

Rear 4,10 H - 18 H or 110/90 H - 18 H.

**Brakes**

Front:

Hydraulic disc brake, (right) twin braking cylinder caliper. Hand lever controlled from the handlebar (R/H). Hydraulic transmission, free from rear braking system.

Disc dia. 300 mm.

Braking cylinder dia. 38 mm.

Master cylinder dia. 12,7 mm.

Twin hydraulic disc brake, (left) featured and dimensioned as above. Pedal lever controlled from the motorcycle (R/H). Hydraulic transmission, bound to rear braking system.

Rear:

Hydraulic disc brake, twin braking cylinder caliper. Pedal lever controlled from the motorcycle (R/H).

Disc dia. 242 mm.

Braking cylinder dia. 38 mm.

Master cylinder dia. 15,857 mm.

Pedal control actuates both twin front (left) and rear brakes at the same time.

**Dimensions and weights**

Wheelbase	m	1,470
Max. width	m	0,780
Max. length	m	2,200
Max. height	m	1,060
Min. ground clearance	m	0,150
Curb weight	kg	243

**Performances**

Maximum speed in each gear, solo riding:

Gears	Speed
low gear	km/h 71,837
second gear	km/h 103,502
third gear	km/h 137,339
fourth gear	km/h 165,329
top gear	km/h 195

Fuel consumption: l. 6 x 100 km.

**Fuel and oil capacities****Group or part**

Fuel tank

(Reserve l. 4)

Sump

Gear box

l. 24 Petrol 98/100 NO-RM

l. 3 Agip SINT 2000  
SAE 10 W/50

l. 0,750 Agip F.1 Rotra MP SAE 90

Rear drive box (bevel set lubrication)	I. 0,230	Agip F.1 Rotra MP SAE 90
	I. 0,020	Molykote type A
Front fork (each leg)	I. 0,050	Agip F.1 ATF Dexron
Front and Rear Brakes		Agip F.1 Brake fluid

**Passing ability  
(U.S. Standards)**

Passing of a 55 feet long truck travelling at 20 m.p.h.

— Time: 6,5 seconds  
— Distance travelled: 334 feet

Passing of a 55 feet long truck travelling at 50 m.p.h.

— Time: 8,7 seconds  
— Distance travelled: 900 feet

The above includes a safety distance of 40 and 100 feet respectively between the passing and pace vehicle at the beginning and end of the manoeuvre.

**Braking ability  
(U.S. Standards)**

Stopping distance from 60 m.p.h. (solo, using both brakes): 177 feet.

Stopping distance with passenger from 60 m.p.h. (using both brakes): 190 feet.

## 10 CONTROLS AND ACCESSORIES

(fig. 2)

- |    |   |    |   |
|----|---|----|---|
| 1  | Master cylinder (right front brake)                   | 14 | Rev. counter  |
| 2  | Control lever (right front brake)                     | 15 | Clutch control lever                                      |
| 3  | Throttle control grip                                 | 16 | Buttons controlling horn, flashing light and turn signals |
| 4  | Engine starting and emergency stopping button         | 17 | Lighting switch   |
| 5  | Key switch  | 18 | Gear change control lever                                 |
| 6  | Fuel tank filler cap                                  | 16 | Buttons controlling horn, flashing light and turn signals |
| 7  | Brake control pedal (left front brake and rear brake) |    | Lighting switch   |
| 8  | Foot-rest   | 17 | Gear change control lever                                 |
| 9  | Pillion foot-rest                                     | 18 | Rear turn signals   |
| 10 | Headlight   | 19 | Tail light  |
| 11 | Front turn signals                                    | 20 | Master cylinder (left front and rear brakes)              |
| 12 | Instrument panel                                      |    |   |
| 13 | Km or mile counter                                    |    |   |

*Right and left hand as seen in riding position.*



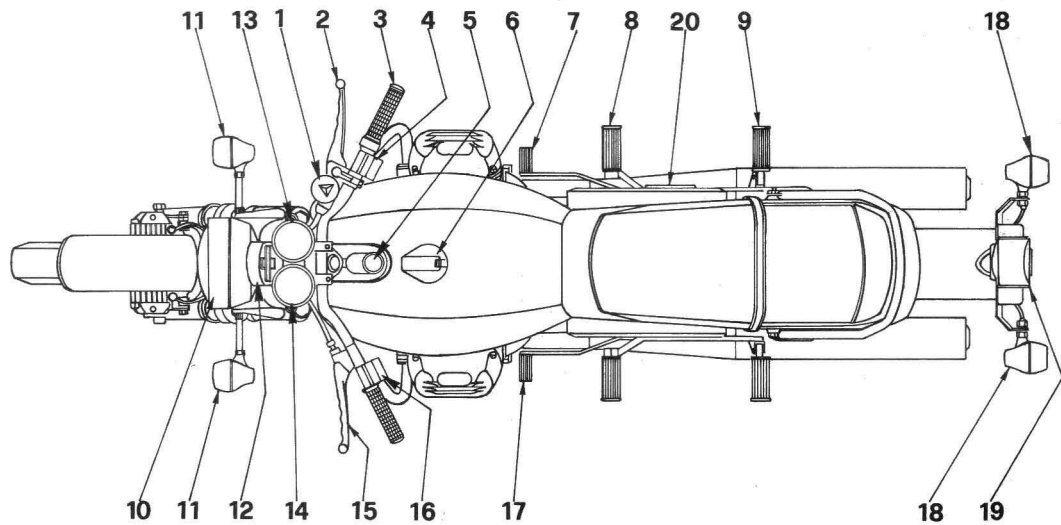

## 12 IDENTIFICATION DATA

Every motorcycle is identified by a serial number which is stamped on the frame downtube and on the crankcase.

The number on the frame downtube appears also in the certificate of conformity and is valid to legal effects for the identification of the motorcycle.

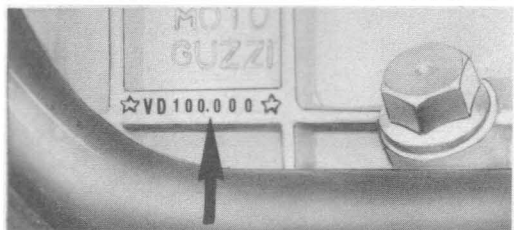
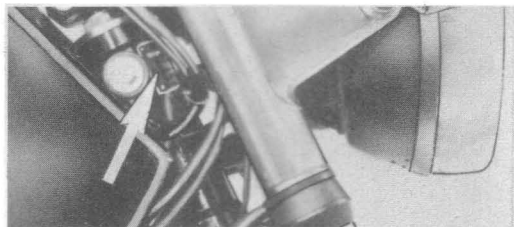

3

## Spare parts

In case of parts replacement, make it sure that «**Original Moto Guzzi Spare Parts**» only are used. **The use of non-genuine parts invalidates the warranty right.**

### Instrument panel (fig. 4)

- 1 Mile counter.
- 2 Rev.-counter.
- 3 Orange neutral indicator. It lights when the gearbox is in neutral position. It may be well to make sure that this position is correct. In any case it is a good practice to pull the clutch before starting.

- 4 Red light indicating parking light on.
- 5 Red warning light. Oil pressure gauge. It goes out when the pressure is sufficient for normal engine lubrication. Should it not go out, the pressure is not correct; in this case the engine has to be stopped and suitable checkings are to be carried out.
- 6 High beam warning light (red).
- 7 Red warning light indicating insufficient cur-

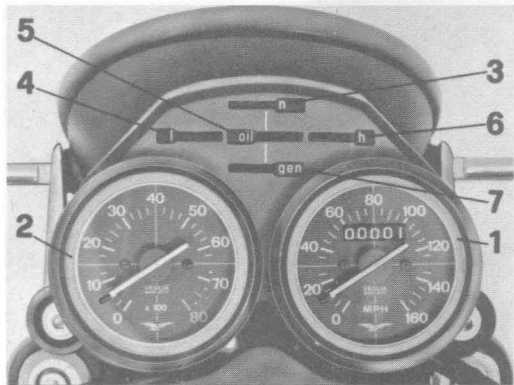

4

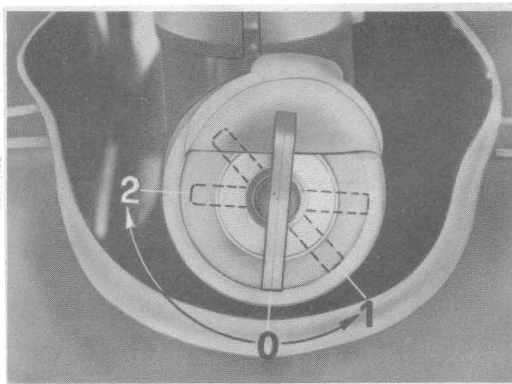

5

- 14 rent from the generator for battery charge. It must go out when the engine reaches a certain number of revolutions.

*By day riding all warning lights are to be out. By night riding the parking warning light only and eventually the high beam warning light are on.*

## **CHANGES FOR «EUROPE MODEL»**

- 1 Km counter.
- 4 Green town driving light.
- 6 High beam warning light (blue).

By night riding the town driving warning light, only and eventually the high beam warning light are on.

## **Key Switch (fig. 5)**

The key has three positions.

- «1» (turned anticlockwise) Standstill, key removable.
- «0» (vertical) Standstill, key not removable.
- «2» (turned clockwise) Ready to start, all controls are in. Key not removable.

## Lighting switch (LIGHTS) (fig. 6 «A»)

Left, on the handlebar, 4 positions.

- «1» OFF Lights off.
- «2» PARK Parking light (USA).  
Town driving light (Europe).
- «3» L Low beam.
- «4» H High beam.
- «5» To come back to position OFF press the button towards the lefts.

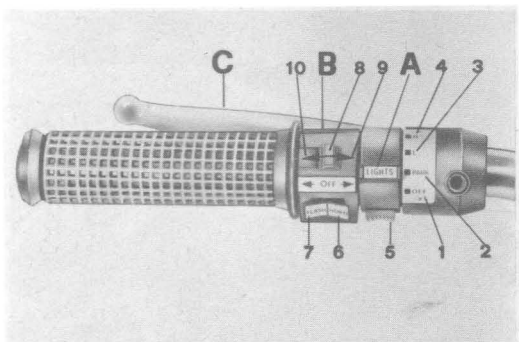

## Horn, flashing light and turn signal controls (fig. 6 «B»)

15

Left, on the handlebar.

- «6» HORN Horn button.
- «7» FLASH Flashing light button.
- «8» OFF Turn signals button.
- «9» When turned to the right operates the right signals.
- «10» When turned to the left operates the left signals.

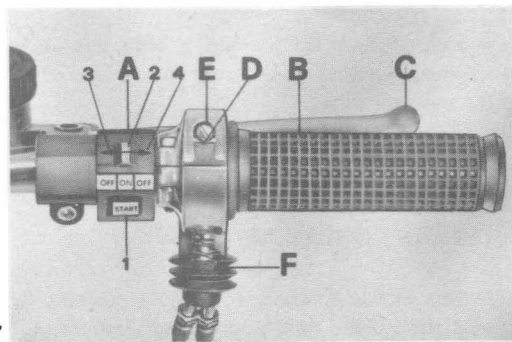

## 16 Engine starting and emergency stopping (fig. 7 «A»)

Right, on the handlebar.

With the ignition key in position «2» in fig. 5, the motorcycle is ready to be started. To start the engine (see «A») presse the button «1» START.

To stop the engine (in case of emergency) turn the button in position «3» or «4» OFF.

After engine stopping reset key in position «O» fig. 5.

### Starter control (fig. 27)

The control lever for starting a **cold engine** is fixed to one of screws securing rocker box cover to left cylinder head.

«A» Starting position.

«B» Riding position.

### Throttle control (B in fig. 27)

Right on the handlebar; throttle is opened by turning toward the rider and closed viceversa.

### Clutch control lever (C in fig. 6)

Left on the handlebar, to be used for starting and gearshifting only.

### Front brake control lever (right)

(C in fig. 7)

Right on the handlebar, connected to its master cylinder.

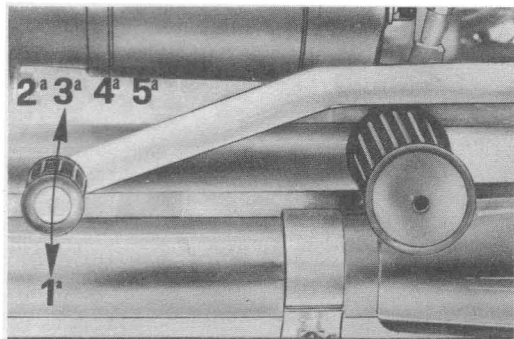

## Brake control pedal (F in fig. 16)

On the right side of the motorcycle.  
It controls both rear and left front brakes, link connected to its master cylinder.

## Gearshift pedal (fig. 8)

On the left side of the motorcycle (fig. 8).  
Low gear: pedal down.  
2. 3. 4. and top gear: pedal up.

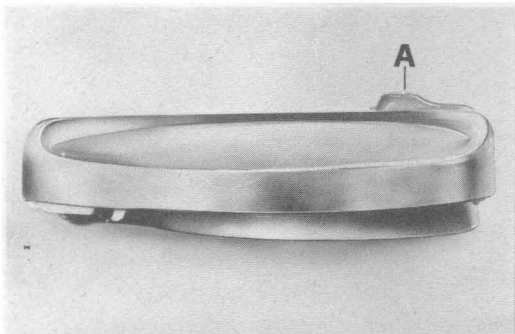

9

Neutral position: between low and 2 nd gear.  
*Before operating the gearshift pedal, the clutch lever has to be completely pulled in.*

17

## Fuel filler cap (fig. 9).

To open it, press the control button «A».

## Fuel taps (fig. 10)

They are located rear, under the fuel tank

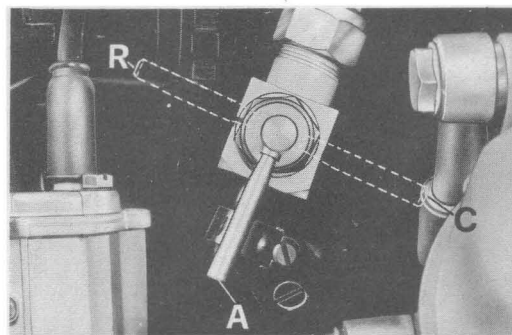

10

18

Positions:

- «A» Open (vertical).
- «R» Reserve (horizontal) see «R» on the taps.
- «C» Closed (horizontal) see «C» on the taps.

### Terminal block with fuses (fig. 11)

It is located under the seat (fig. 11) and holds n. 6 15 A fuses.

- «1» Rear stop light horn, flashing light.
- «2» Starting relay. Turn signals.

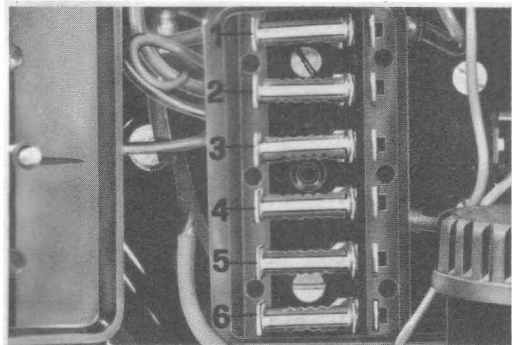

11

- «3» Warning lights. Oil-gen-N Low - High beam with warning light.
- «4» Parking or town driving lights - Instruments.
- «5» } Spare fuse.
- «6» }

### Steering locking («A» in fig. 12)

To lock:

- turn handlebar fully to the right.
- insert key into lock set, turn it anticlockwise

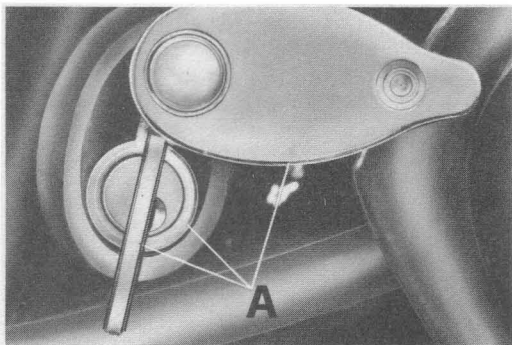

12



and push it fully in, release it and take it off.

To release:

- insert key into lock set, turn it anticlockwise release it and take it off.

## Side Stand

The side stand is useful for short staying. His of automatic return type. For longer staying use central stand.

## 20 RIDING INSTRUCTIONS

### Checking

Before starting the engine ensure that:

- there is sufficient fuel in the tank;
- the oil level in the engine sump is correct;
- the ignition key is in position «2» (see fig. 5);
- the warning lights: **red** (oil pressure gauge and generator); **orange** (neutral indicator); **green-or red** (for night riding) are lit;
- the starter lever for cold engine is in starting position see A in fig. 27.

### Engine starting

After the first checking, turn the twist grip 1/4 towards the rider and push the start button, right on the handlebar «1» START in fig. 7.

After the engine has been started, before returning the starter control levers into riding position see «B» in fig. 27 let the engine idle a short while in the hot season and a few minutes in the cold season.

**Should the control starter levers be left start-**

**ing position «A» in fig. 27 by riding, there would be irregular carburation and increased fuel consumption and even worse, there could be the possibility of seizures because of too much petrol going into the cylinders.**

*Do not forget that if the engine is in gear, the neutral indicator light (orange) is not lit; to start the engine in such conditions could be very dangerous, unless the clutch is kept fully disengaged, as the motorcycle itself may start off.*

### Starting a hot engine

In this case it is not necessary to set the starter control levers on the carburetors in starting position («A» in fig. 27) as this would richen the carburation too much.

### On the way

To change to another gear close the throttle, pull in completely the clutch lever and shift in-

to the new gear; release gently the clutch lever and open the throttle at the same time. The gearshift pedal has to be firmly actuated and foot accompanied.

When shifting down to a lower gear, gradually operate brakes and throttle control not to cause the engine to go over revs when releasing the clutch lever.

## Stopping the motorcycle

Close the throttle control and simultaneously operate both the brake control levers, the clutch lever will be pulled in when the motorcycle comes almost to stopping.

This manoeuvre has to be very co-ordinately carried out not to let the motorcycle going beyond control.

To normally reduce speed, use the engine braking power by correctly gearshifting and paying attention that the engine does not go over revs. On wet or slippery roads, the brakes, especially the front one, (right) have to be carefully operated. To stop the engine turn the ignition key to position «0» see fig. 5.

**When the engine is stopped remember to close the taps by turning them to position «C» in fig. 10.**

## Parking

By parking on insufficiently lighted roads, it is necessary to let the parking or town driving light on, by turning the ignition key to position «1» in fig. 5 and the light switch A (LIGHTS) to position «2» (PARK) see fig. 6.

To lock the steering see fig. 12 and proper instructions.

## Running in

During the running in a new or overhauled motorcycle has to be used very carefully; as efficiency, performance and of the engine are largely dependant on how the motorcycle is run in.

The engine should never be allowed to reach a high number of revolutions before having a chance to warm up sufficiently.

Never exceed the following speeds and do not force the engine long time.

**After the first 500 km (300 miles)**

Change the engine oil.

Tighten all nuts and bolts.

Check, tighten spokes.

If necessary adjust valve rocker clearance.

Check double contact breaker points gap.

**Every 500 km (300 miles)**

Check oil level; correct level nearly at the maximum mark (see the marks on the oil filler cap dipstick).

Screw the cap fully in for this checking.

**Running in speeds**

Distance	Max. permissible speeds km/h (miles/h)				
	low gear	2nd gear	3rd gear	4th gear	5th gear
Up to 800 km (500 miles)	45 (28)	65 (40)	85 (53)	100 (62)	115 (72)
From 800 up to 1600 km (500 1000 miles)	55 (34,5)	80 (65)	105 (65)	120 (75)	140 (87,5)
From 1600 up to 3000 km (1000 1800 miles)	Gradually increase speed to max. permissible limits.				

## MAINTENANCE

### Adjusting the clutch lever (fig. 13)

If the free play at the handlebar is lighter or lower than mm 4, slacken thumb screw «B» and screw in or out adjuster «A» to obtain the correct play. This adjustment can also be carried out by slackening nuts «C» and acting on adjuster «B» that is located right on the gear box.

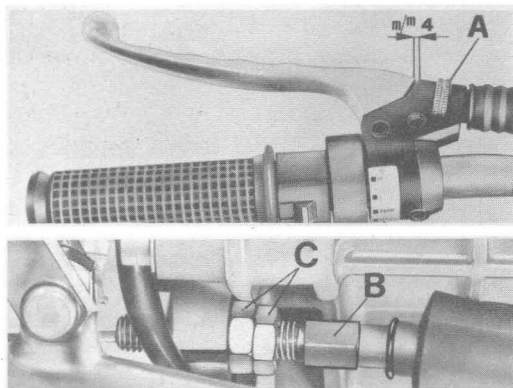

13

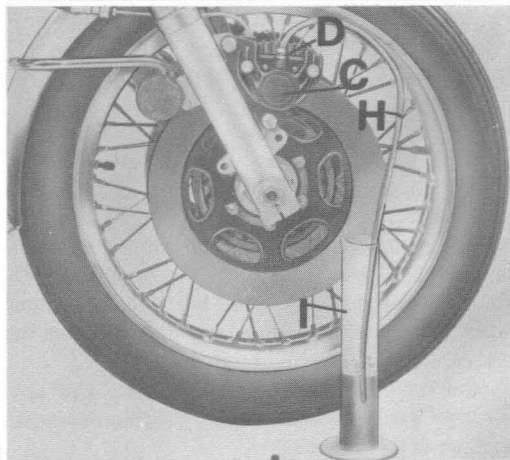
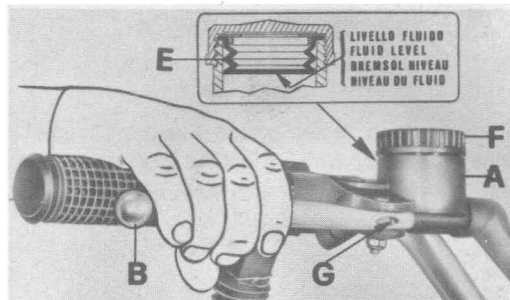

14

## 24 Adjusting the front brake (right) control lever (fig. 14)

After fitting a feeler gauge between floater in master cylinder and the end of the control lever get the correct play of mm.  $0,05 \div 0,15$  by acting on screw «C».

## Checking brake pads wearing

Every 5000 km (3000 miles) check brake pad thickness:

- new pad : mm 9;
- wear limit : mm 6 a.

If thick. is under the wear limit, it is necessary to replace the pads. After this operation has been carried out, do not drain the air but only operate the control lever on the handlebar «B» fig. 14 several times until the caliper pistons reach their normal position; pad distance from the disc a. 0,2 mm.

By the replacement of the pads check the condition of the fluid pipes, should they be damaged, replace them immediately.

## Checking the brake discs (L fig. 14-15)

The brake disc must be accurately clean, without oil, fat or other dirt and must not show any deep scoring.

In case of replacement or overhauling of the brake disc, it is necessary to check its wobbling. This checking is carried out by means of a proper gauge that must never read more than 0,2 mm.

Should wobbling be higher, carefully check the mounting of the disc on the hub and the play of the hub bearings.

Connection torque between disc and hub is kg/m  $4 \div 4,3$ .

## Checking the fluid level and changing the fluid in reservoirs (fig. 14-15)

For a good working of brakes these directions are to be followed:

- periodically check the fluid level (it has to be nearly at the gaiter «E» located in the fluid reservoir «A» on the right handlebar for the right

front brake and under the right battery cover for both left front and rear brakes; it has never to be lower than 8 mm under maximum level;

- periodically top up the fluid reservoir «A» (if necessary) after loosening the cap «F»; take the fluid from an original container which must only be opened when using the fluid;
- completely renew the brake fluid every 15.000 km (9000 miles) or at least once a year.

The fluid pipes have to be always full and without air; a long and elastic movement of the control lever «B» evidences the presence of air inside them.

Use only fresh fluid in case of washing.

**No alcohol is to be used for washing and no compressed air for drying up; use Trichloroethylene for metallic parts.**

Fluid to be used «Agip F. 1 brake fluid».

## Air bleeding (fig. 14-15)

This operation is required when the movement of the control lever on the handlebar is long and elastic because of the presence of air inside the braking circuits.

Operations are as follows:

## Front braking circuit, right (fig. 14)

- turn the handlebar until master cylinder (fluid reservoir) «A» reaches the horizontal position;
  - if necessary, top up the fluid reservoir «A» (take care that during the air draining the fluid does not go 8 mm lower than the maximum level);
  - act on a caliper body only «C» at a time:
    - a) take out the rubber cover, then fit a transparent flexible pipe «H» on the drain plug «D»; the other end of this duct will be plunged into a transparent container «I» partially filled up with fluid of the same type;
    - b) loosen the drain plug «D»;
    - c) completely operate several times the brake control lever «B» on the handlebar, release it slowly and wait for a few seconds before operating it again. Repeat this operation until the plunged into the transparent container pipe emits airless fluid;
    - d) keep the control lever «B» completely drawn and lock the drain plug «D», then remove pipe «H» and mount the rubber cover.
- If the air bleeding has been correctly carried out, a direct and efficient working of the fluid will be

26 realized immediately after the initial idle movement of the lever «B»; otherwise repeat the whole operation.

## Rear and left front braking circuits (fig. 15)

Proceed as by the right front braking circuit, with following changes:

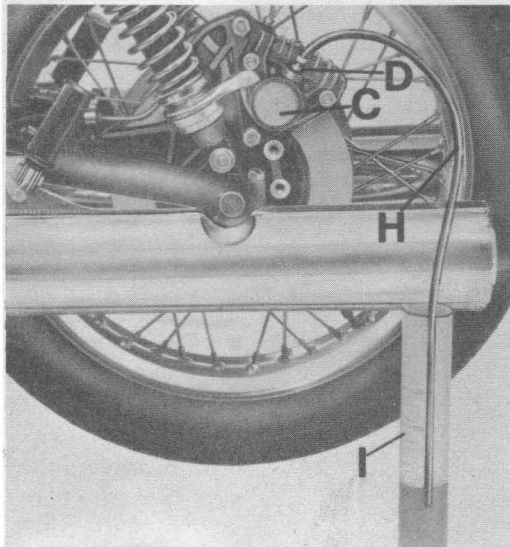
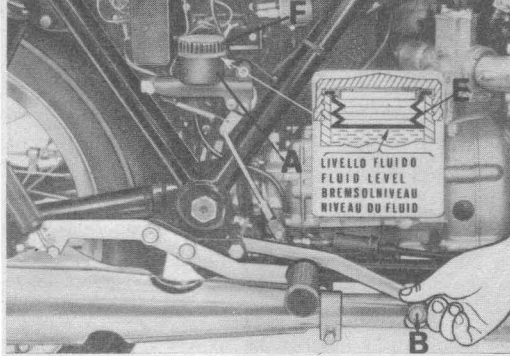
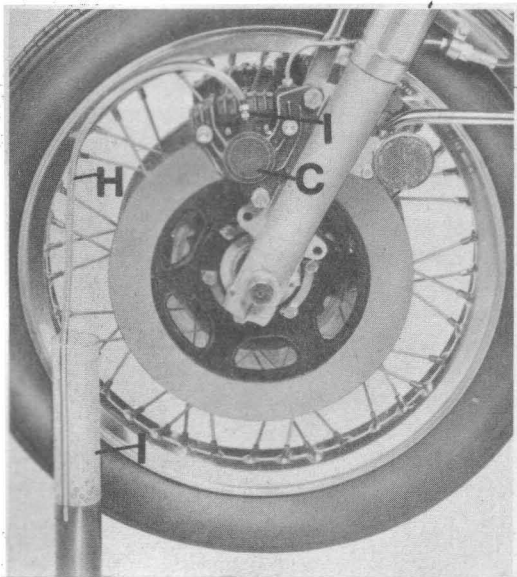



point c: completely operate the control pedal «B» at the R/H side of the motorcycle;  
 point d: keep the control pedal «B» completely pushed down.

## Adjusting the control pedal for rear and left front brakes

(fig. 16)

— fit a feeler gauge between floater in master

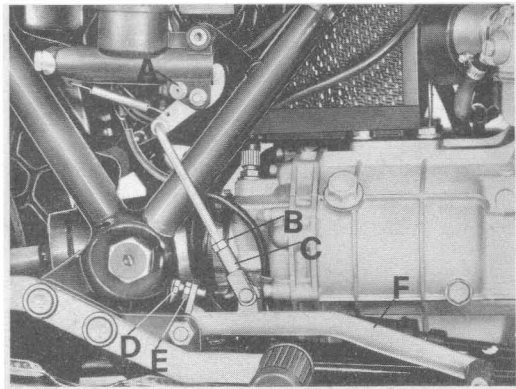

16

cylinder and lever end «G» then get the correct play of mm 0,05 0,15 by acting on adjuster «A»;

— remove circlip, slip out pin and loosen counternut «B»; now screw in or out fork «C» until the ideal position of control pedal «E» is reached;

— re-fit pin and circlip.

After adjusting, loosen counternut «E» and adjust lever return stop screw «D».

27

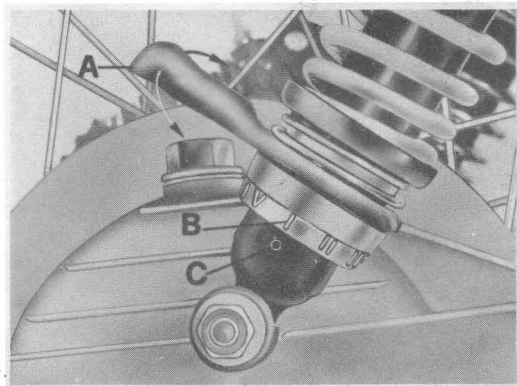

17

## 28 Adjusting the rear suspensions (fig. 17)

The external springs of rear suspensions can be adjusted on five positions by acting on the levers «A».

Starting from position «I» in correspondence with the red mark «B» turn the lever «A» (see the arrows) into positions «II», «III», «IV», «V», ta-

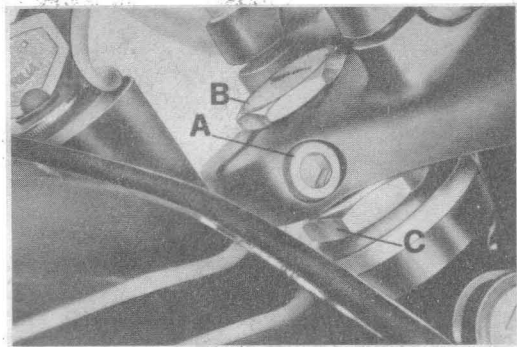

king care that they must always be in correspondence with the red mark «B».

In case of faulty damper operation, have them checked by our dealers.

*Do not forget that the two springs have to be adjusted at the same position, to ensure a good stability of the motorcycle.*

## Adjusting the steering (fig. 18)

For a safe riding, steering has to be so adjusted to allow a free movement of the handlebar but without excessive play.

To correctly adjust steering operate as follows:

- slacken the steering head fixing bolt «A»

loosen the nut «B» and screw in or out the adjuster «C» to take up excessive play. After this adjustment has been made, lock nut «B» and the steering head fixing bolt «A».

*It is recommended to have this operation carried out by our dealers.*

## REMOVAL OF WHEELS

29

### Front wheel (fig. 19)

- undo caliper «A» securing screws and remove caliper «A» with pipe from right fork cover.
- Undo wheel spindle lock nut «B» (left side).

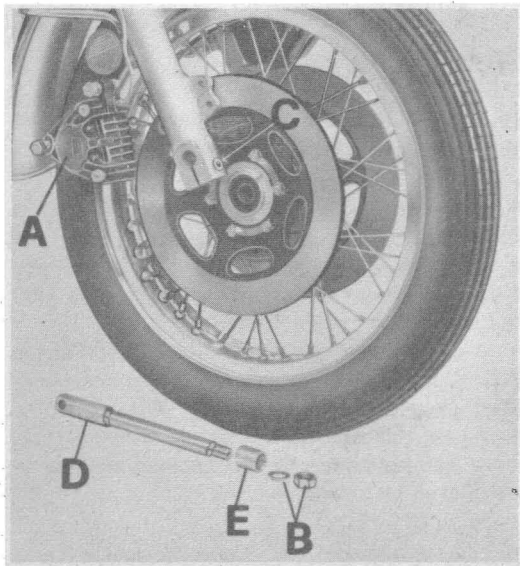

19

- Undo screws securing fork covers to wheel spindle «C».
- Slip off spindle «D»; care the position of spacer «E».
- Lift the motorcycle so to disengage the braking disc (left wheel side) from caliper.

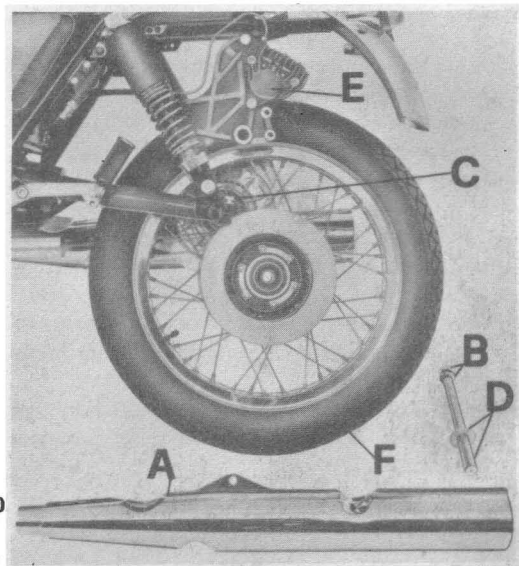

20

## 30 Adjusting the spokes

Check that all spokes are tightened and the wheel is correctly trued by proceeding as follows: To re-assemble the wheel operate viceversa; after re-assembling check clearance between pad and disc. (See chapter «Checking pad wearing»).

### Rear wheel

- Undo the screw securing left silencer to frame; and remove silencer from exhaust tube after undoing the screw securing its fixing clamp.
- Loosen nut «B» on the spindle, drive box side.
- Undo wheel spindle securing screw «C», on rear hwinging arm.
- Take spindle «D» out of drive box, wheel hub and rear swinging arm.
- Take braking disc out of caliper «E».
- Remove caliper from stop pin on rear swinging arm; place it on motorcycle lifting hand-grip.
- Lean the motorcycle to the right so to free the wheel «F» from rear swinging arm and drive box.

To re-fit the wheel operate viceversa.

Remember to fit caliper on the rear swinging arm (left) and to check clearance between pad and braking disc. (See proper chapter in section «Maintenance»).

- spin the wheel and check its truing if necessary act on right or left spokes until the wheel turns properly. This checking has to be carried out after the first 500 km (300 miles) and later on, every 1500 km (900 miles) or so.

### Wheel balance

To improve stability and decrease vibrations at high speeds the wheels have to be kept balanced. Operations are as follows:

- after removing the wheel and checking spoke tightening and wheel truing suspend it on a fork;
- spin the wheel lightly several times and see if it stops always in various positions, thus indicating a correct balance;
- if one point of the wheel always stops at the bottom, put a balance weight on a spoke opposite that point.
- repeat this operation until the wheel is correctly balanced then fix the balance weights to the spokes by means of pliers.

Balance weights are available from our dealers in sizes of 15, 20, 30 grams.

Normally, an imbalance of less than 15 grams does not affect the motorcycle stability.

## Tyres

The tyre condition is of main importance as stability of motorcycle, riding comfort and even rider safety are depending on this factor.

It is therefore quite advisable not to use tyres with tread lower than 1,5 ÷ 2 mm respectively front and rear tyre.

A wrong tyre pressure can also affect stability of motorcycle and shorten tyre life.

Correct pressure is:

- front wheel: solo or with pillion kg/cm<sup>2</sup>: 2
- rear wheel: solo kg/cm<sup>2</sup>: 2,3
- with pillion: kg/cm<sup>2</sup>: 2,5.

These data are for normal riding (touring). In case of constant high speed or motorway riding increase tyre pressure 0,2 kg/cm<sup>2</sup>.

## 32 LUBRICATION AND MAINTENANCE CHART

(fig. 21)

### Monthly every 3000 km (2000 miles)

- 1 Check electrolyte level in battery (see chapter **Electrical Equipment** «Battery»).

### Periodically

- 2 Check tyre pressure (see «Tyres»).

### Every 500 km (300 miles)

- 3 Check oil level in the crankcase (see chapter **Lubrications**).

### After the first 500 ÷ 1000 km (300 ÷ 600 miles)

- 4 Replace the crankcase oil (see chapter **Lubrications**).

- 5 Tighten all nuts and bolts.

- 6 Check spoke tightening and wheel truing (see chapter **Removal of wheels**).

- 7 Check rocker clearance (see chapter **Valve gearing** «Tappet clearance»).

### Every 1500 km (900 miles)

- 8 Check spoke tightening and wheel truing (see chapter **Removal of wheels**).

### Every 3000 km (2000 miles)

- 9 Replace oil in the engine crankcase (see chapter **Lubrications**).

- 10 Check rocker clearance (see chapter **Valve gearing** «Tappet clearance»).

- 11 Check the oil level in the gear box (see chapter **Lubrications**).

- 12 Check oil level in the rear drive box (see chapter **Lubrications**).

## Every 5000 km (3000 miles)

**13** Check the fluid level in brake fluid reservoirs (see chapter **Maintenance** «Brakes»).

## Every 10000 km (6000 miles)

**14** Clean the fuel tank, the fuel taps, the filters and the fuel lines (see chapter **Maintenance** «Cleaning the fuel tank, filters, tape and fuel lines»).

**15** Replace the oil in the gear box (see chapter **Lubrications**).

**16** Replace the oil in the rear drive box (see chapter **Lubrications**).

**17** Clean and smear all battery connections (see chapter **Electrical equipment** «Battery»).

**18** Replace air filter (see chapter **Air filter**).

## Every 15000 km (9000 miles)

33

**19** Replace the fluid level in brake fluid reservoirs (see chapter **Maintenance** «Brakes»).

## After the first 20000 km (12000 miles)

All checkings hereunder described must be carried out by our dealers:

**20** Check there is sufficient grease in the wheel bearing «Agip F.1 Grease 30» or equivalent.

**21** Check there is sufficient grease in the steering bearings «Agip F.1 Grease 30».

**22** Replace the oil in the fork covers (use «Agip F.1 ATF Dexron») quantity l. 0,020 (half a glass a.) per cover.

**23** Clean starter motor and generator commutators using a clean rag slightly moistened with petrol.

EVERY 500 KMS ( 300 MILES): \_\_\_\_\_

AFTER THE FIRST 500-1000 KMS  
(300 ÷ 600 MILES) \_\_\_\_\_

EVERY 1500 KMS ( 900 MILES): \_\_\_\_\_

EVERY 3000 KMS (1800 MILES): \_\_\_\_\_

2 PERIODICALLY \_\_\_\_\_

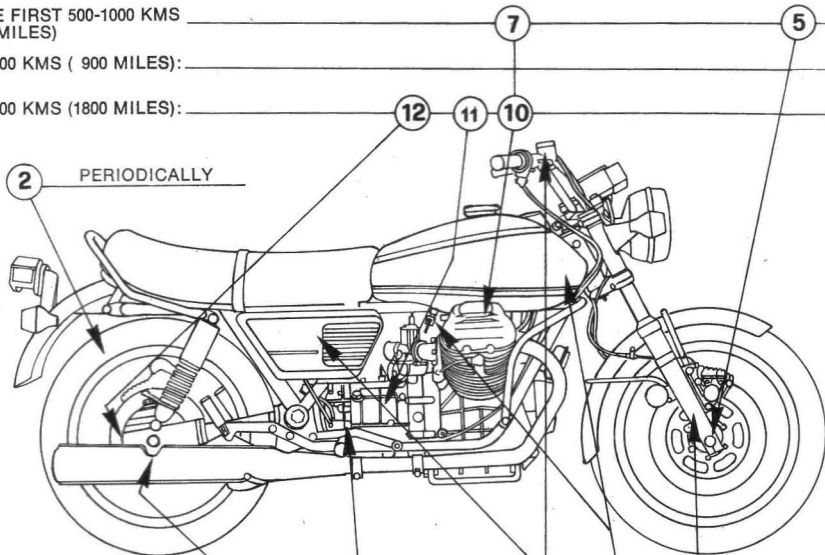

EVERY 5000 KMS ( 3000 MILES): \_\_\_\_\_

EVERY 10000 KMS ( 6000 MILES): \_\_\_\_\_

EVERY 15000 KMS ( 9000 MILES): \_\_\_\_\_

EVERY 20000 KMS (12000 MILES): \_\_\_\_\_

15

13

16

14

19

22



- MAINTENANCE
- △ AGIP SINT 2000 SAE 10W/50
- AGIP F. 1 ROTRA MP SAE 90
- ◇ AGIP F. 1 ATF DEXRON
- ▭ AGIP F. 1 GREASE 30
- ☆ AGIP F. 1 BRAKE FLUID

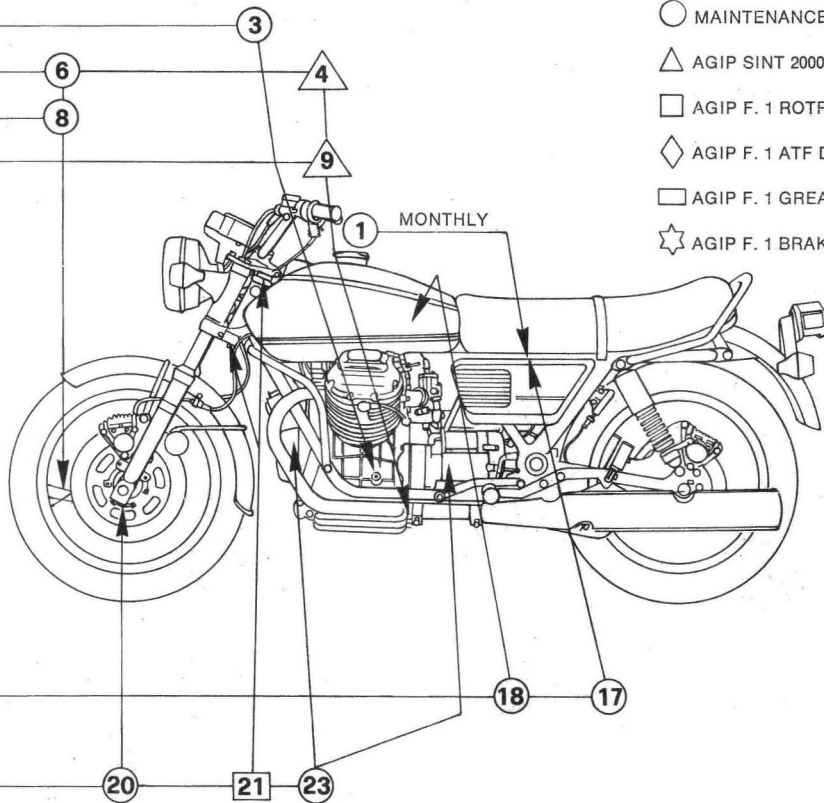

## 36 LUBRICATIONS

### Engine lubrication (fig. 22)

#### Engine oil

Using the oil filter dipstick «A» check the sump level every 500 km (300 miles).

Correct oil level is nearly at the maximum mark. Should the level be lower than recommended, fill up with oil of the same type and features.

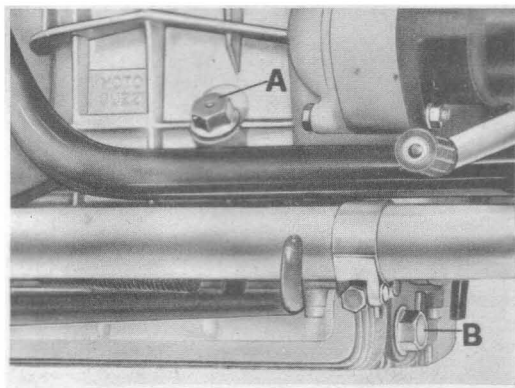

22

Let the engine turn for a few minutes; oil filter dipstick «A» fully screwed.

#### Replacing the engine oil

After the first 300 ÷ 500 km (200 ÷ 300 miles) a. and later on every 3000 km (200 miles) or so, change the engine oil.

The oil has to be replaced when the engine is

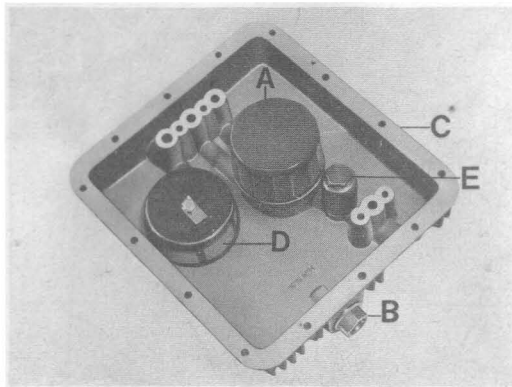

23

warm. Remember to allow all the old oil to drain before introducing fresh oil.

«A» oil filler cap.

«B» oil drain plug.

Quantity required:

l. 3 «Agip Sint 2000 SAE 10W/50».

### Replacement of filter cartridge and cleaning the wire gauze filter (fig. 23)

To replace filter cartridge «A» proceed as follows:

- Undo plug «B» and let the oil fully drain.
- Undo securing screws and remove sump «C» from crankcase. The sump fits also filter cartridge «A», wire gauze filter «D», oil pressure relief valve «E».
- Undo filter cartridge «A» and replace it by an original one.

It is also advisable to remove also wire gauze filter «D», to wash it in petrol bath and dry it by means of compressed air jet. Before re-fitting blow the sump too with compressed air.

Replace the gasket between sump and crankcase before mounting the sump.

This maintenance is best done by our dealers.

## Gear box (fig. 24)

### Checking the oil level

Every 3000 km (200 miles) check that the oil level is nearly at the inspection hole «B».

If this level is not correct, fill up with oil of the same type and features.

### Changing the oil

Every 10000 km (6000 miles) or so, change the oil in the gear box.

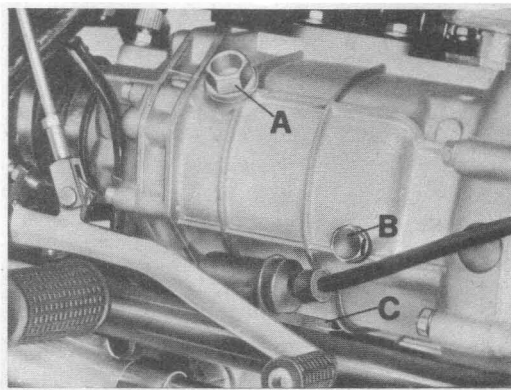

**38** This operation should be carried out a short time after a ride when the oil is still warm and easily drained.

Remember to drain all the old oil before introducing fresh oil.

«A» oil filler cap.

«B» level inspection plug.

«C» oil drain plug.

Quantity required: l. 0,750 of oil «Agip F.1 Rotra MP SAE 90».

## Rear drive box (fig. 25)

### Checking the oil level

Every 3000 km (2000 miles) check that the oil level is nearly at the inspection hole «A».

If the level is not correct, fill up with oil of the same type and features.

### Changing the oil

Every 10000 km (6000 miles) change the oil in the rear drive box.

This operation should be carried out a short time after a ride when the oil is still warm and easily drained.

Remember to drain all the old oil before introducing fresh oil.

«A» inspection level plug.

«B» oil filler cap.

«C» oil drain plug.

Quantity required:

l. 0,230 of oil «Agip F. 1 Rotra MP SAE 90»

l. 0.020 of oil «Molykote A».

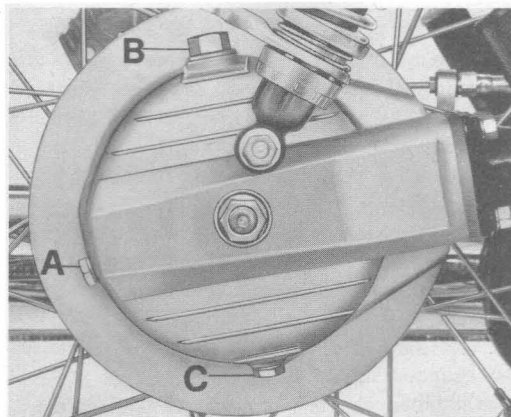

## Front fork (fig. 26)

To replace the lubricating oil in fork covers proceed as follows.

— Undo the drain plug «A» with gasket.

— Undo screw «B».

Remember to let fully drain, before filling with fresh oil.

«A» oil drain plug.

«B» oil filling screw.

Q.ty required l. 0,050 (half a glass a.) for each cover «Agip F.1 ATF Dexron».

## Steering, wheel bearings, and rear suspension

For these lubrications it is suggested to apply to our dealers.

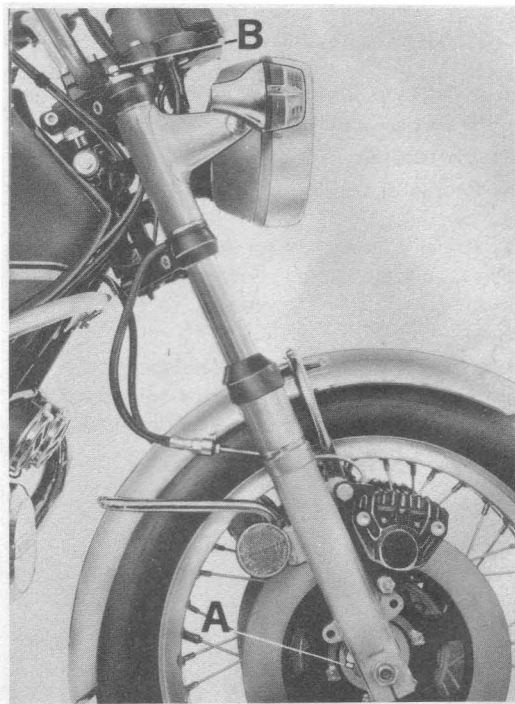

## 40 CARBURATION

### Carburetors (fig. 27)

N. 2 Dell'Orto Carburetors «VHB 30 CD» (right)  
«VHB 30 CS» (left).

Double controls:

- throttle control grip, («B» in fig. 27) right on the handlebar;
- starter control lever for starting a cold engine, located on left cylinder head cover «A»: starting position, «B»: riding position.

*Note:*

*When the starter lever is in riding position «B» ensure that there is a clearance of about 3 mm. between starter control cable ends and adjuster screws on both carburetors.*

### Standard carburetor setting

Choke	Ø mm 30
Throttle	40
Atomizer	265
Main jet	120
Idling jet	50
Starter jet	80

Needle

V 9 (2nd notch)

Float

10 grams

Idling adjuster screw: open 1 turns and a half.

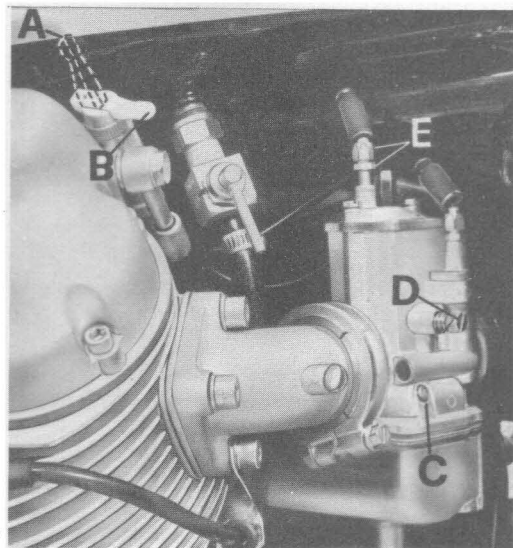

## Adjusting the carburation (fig. 27)

Adjusting by hand.

This adjustment is made as follows:

- 1 Get the engine at its running temperature.
- 2 Screw idling adjusting screws «C» fully in; then screw them out by one turn and a half.
- 3 By means of your hands feel if pressure at exhaust tubes is the same. In case of differences, act on screw «D» of one carburettor until the pressure will be the same (idling speed will be kept at 900-1000 r.p.m. about; consequently it will be necessary to screw in the carburettor screw of the cylinder having a lower pressure or to screw out the carburettor screw of cylinder having a higher pressure).
- 4 Get the best carburation for each cylinder by acting on screws «C» (this will be at the point where the r.p.m. increase slightly) then get idling speed according to point 3.
- 5 Disconnect one plug lead at a time and check that the engine stops after firing 5-6 strokes. If this does not occur, get it by proceeding as follows:
  - screw out screw «D» of the cylinder causing the engine firing more than 5-6 strokes;

— screw in screw «D» of the cylinder causing the engine firing less than 5-6 strokes.

- 6 Adjust idling speed to 900-1000 r.p.m. by screwing in or out in the same quantity screws «D».
- 7 After closing the throttle control grip, check that there is a clearance of mm  $1 \div 1,5$  between cable ends and adjuster screws «E».
- 8 Check that both gas valves open at the same time by proceeding as follows:
  - Turn slowly the throttle control grip and check by means of your hands that the pressure at exhaust pipes increases simultaneously. In case such increase is not simultaneous, adjust the carburettor of the cylinder in question by screwing adjuster «E» in (after loosening its counternut) until the pressure is the same for both pipes.

## Adjusting by means of a «Vacuum Meter»

To get a correct adjusting of carburation, it is advisable to apply to our dealers who can carry it out by means of a «Vacuum Meter».

## 42 Air filter cartridge (fig. 28)

Every 10000 km or so, replace the air filter cartridge «A». It is located in a proper housing which is joined to the oil breather assembly under the fuel tank.

This replacement is better done by our dealers.

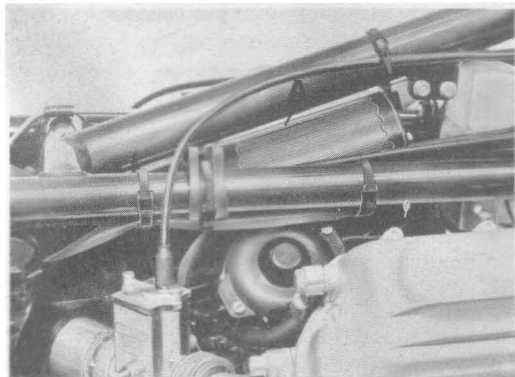

## Cleaning the fuel tank, fuel tap, fuel filters and fuel pipes

Every 10000 km or whenever there is an irregular fuel flow to carburetors, it is necessary to clean the fuel tank, the fuel taps, the fuel filters and the fuel pipes as well.

Ducts, filters on taps and carburetors, and pipes will be washed in petrol bath and dried with compressed air.



## VALVE GEARING

### Tappet clearance (fig. 29)

Every 3000 km (2000 miles) or any time valve operation is too noisy, tappet clearance should be checked.

This adjustment is made on a cold engine with the piston at TDC exactly at the end of its compression stroke.

After removing the cylinder head cover, operate as follows:

- 1 slacken nut «A»;
- 2 screw in or out the adjuster screw «B» until the following clearances are obtained:
  - inlet valve mm 0,22;
  - exhaust valve mm 0,22.

Use a feeler gauge «C» to check this clearance. When this is excessive, there will be noisy valve operation: if it is less, the valves may not close fully causing inconveniences such as:

- compression loss;
- engine overheating, etc.

On a new engine, this adjustment must be made after the first 500 km (300 miles).

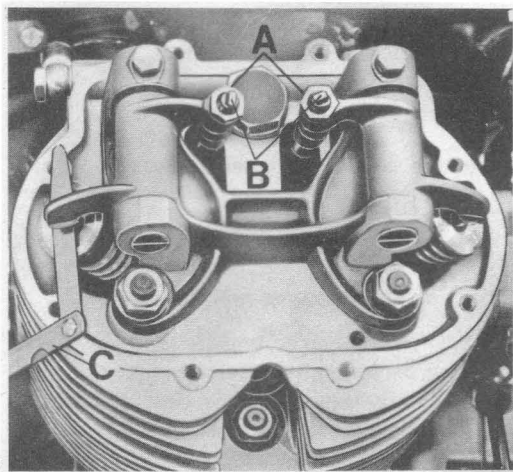

## 44 IGNITION

### Checking and adjustment of double contact breaker (fig. 30)

#### Maintenance

Every 3000 km (2000 miles)

Lightly moisten with some engine oil drops the cam felt «R».

#### Inspection

- remove the contact breaker cover by undoing the securing screws;
- if contacts «A» and «B» are dirty and greasy, clean them with a petrol moistened rag. If they are in any way damaged replace them;
- check points gap of breaker «A» (right cylinder - red cable) and breaker «B» (left cylinder - green cable) which should be between mm 0,37 ÷ 0,43. If this distance is higher or lower, the points have to be adjusted.

#### Adjustment of contact points

##### Contact points «A» - right cylinder

Bring cam «I» to maximum lift, loosen screws «C» and «D» and move plate «E» by acting on nocht «F».

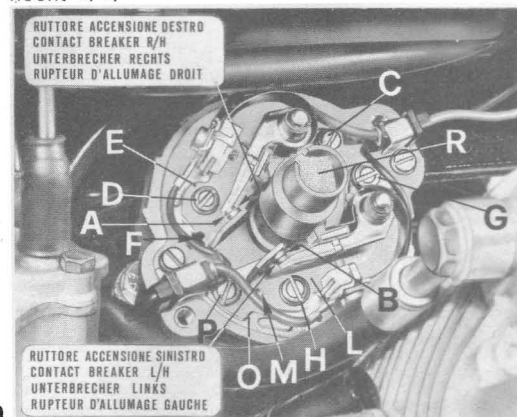

After setting the correct distance, lock screws «C» and «D».

#### **Contact points «B» - left cylinder**

Bring cam «I» to maximum lift, loosen screws «G» and «H» and move plate «L» by acting on notch «M».

After setting the correct distance, lock screws «G» and «H».

*When adjusting the contact points ignition timing should be checked as well (see chapter «Checking of ignition timing»).*

## 46 Checking and adjustment of ignition timing «fixed advance» (fig. 31)

### Checking

- remove the rubber cap which seals the inspection hole on the right side of the gear box;
- to find the exact moment when the points «A» and «B» in fig. 30 start separating, it is advisable to use a suitable timing light device mounted in, between the breaker feeding clamp and the ground.

#### Timing the right cylinder (see fig. 31)

- rotate the flywheel anticlockwise until the piston is at the end of its compression stroke (both valves closed). In this position, mark «D» on the flywheel (TDC of right cylinder) should coincide with mark «1» on the rim of the inspection hole;
- rotate the flywheel clockwise until the flywheel mark «2» (fixed advance) is in perfect coincidence with mark «1» on the rim of the inspection hole. In this position the ignition fixed advance mark «2» is  $2^\circ$  from TDC («D») that's at

the beginning of the points separation («A» in fig. 30).

31

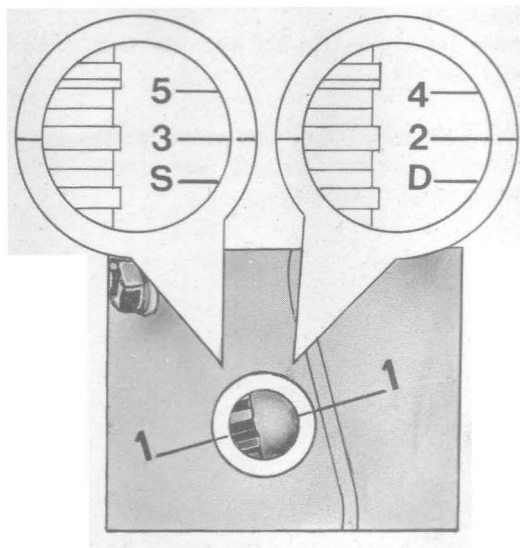

### Timing the left cylinder (see fig. 31)

- rotate the flywheel anticlockwise until the piston is at the end of its compression stroke (both valves closed). In this position, mark «S» on the flywheel (TDC of left cylinder) should coincide with mark «1» on the rim of the inspection hole;
- rotate the flywheel clockwise until the flywheel mark «3» (fixed advance) is in perfect coincidence with mark «1» on the rim on the inspection hole. In this position the ignition fixed advance mark «3» is 2° from TDC («S») that's at the beginning of the points separation («B» in fig. 30).

*If the points («A» and «B» in fig. 30) do not start opening in the above positions, the ignition timing needs adjustment.*

### Ignition data

Initial advance (fixed)	2°
Automatic advance	31°
Total advance	33°
Breaker points gap:	mm 0,37 ÷ 0,42

*This checking is best carried out by our dealers.*

### Spark plugs

Type spark plugs (see page 5)

Points gap 0,6 mm.

The spark plugs are best cleaned with petrol and a wire brush using a needle for the inner part.

In re-fitting the plugs ensure they are properly started by hand for a few turns completing the operation by means of the plug wrench in the tool kit. If not properly started the cylinder head thread may get stripped.

For all events, the plugs have to be replaced every 10000 km a. even if they still appear to be in good condition.

## 48 ELECTRIC EQUIPMENT

It includes the following:

- Battery.
- Starter motor with electro-magnetic relay.
- Generator-Alternator, located on the front side of crankshaft.
- Double contact breaker with automatic advance.
- Ignition coils.
- Rectifier.
- Regulator.
- Terminal block with fuses (n. 6 16A fuses).
- Flashing relay.
- Starter relay.
- Headlight.
- Tail light.
- Lights for turning signals.
- Ignition switch.
- Lighting switch
- Switch for turning signals, horn and flashing light.
- Engine starting and stopping switch.
- Horn.

### Battery

Battery is a 12V type with a capacity of 32 Ah and direct charge from generator. Access to the battery is made possible by following operations:

- lift the saddle by means of lifting lever.
- remove the tool box.
- unhook the rubber bands and disconnect electric wires.

### Putting a dry battery into service

**1** Unscrew the plugs, and introduce pure sulphuric acid for batteries with a specific gravity 1,28 Kg/l (1,23 kg/l in tropical climates) and temperature of + 20 °C until the minimum level mark on the battery is reached. At introduction, acid temperature must not be lower than + 10 °C. Do not use metal funnels.

**2** Let the battery at rest for about 1 hour, then top up to the recommended level by adding sulphuric acid. Charge now the battery for 15 hours in C.C. - Amp. 1,1.

Start charging only when temperature is lower than + 40 °C (+ 50 °C in tropical climates).

To charge the battery connect positive pole (+) of battery to positive pole (+) of supplier; same connection for negative poles (—).

During charging, the temperature of acid must not be higher than + 45 °C (+ 55 °C in tropical climates); otherwise stop charging or reduce current.

The initial charging will be accomplished when acid density and current intensity rates will remain the same for at least 2 consecutive hours of charge.

At this point specific gravity of acid will have to be 1,28 kg/l  $\pm$  0,01 (1,23 kg/l  $\pm$  0,01 in tropical climates) at + 20 °C.

Remember that acid specific gravity varies in rates of 0,01 for each 14 °C change in temperature. This means that the specific gravity which is measured for an acid temperature of + 34 °C, will have to be increased of 0,01 to get the same for + 20 °C acid temperature.

Two hours after accomplishing of charge, check acid level and if necessary top up by adding distilled water; screw in plugs. The battery is now in service.

Periodically check electrolyte level, whenever necessary top up with distilled water only. Check cleaning and locking condition of battery connection; smear them with neuter vaseline.

## 50 LIGHTS (Europe model)

### Headlight

- high and low beam: bulb 45/40 W - 12 V
- town driving light: bulb 3 W - 12 V

### Tail light

- number plate lighting, parking light and stop light: bulb 5/21 W - 12 V.
  - Turn signals: bulb 21 W - 12 V.
- Indicators, instrument panel: bulb 1,2 W - 12 V.  
Indicators, km and rev. counters: bulb 3 W - 12 V.

### Replacement of bulbs (fig. 32)

#### Headlight

- Undo screw «B», disconnect beam insert, slip off sockets and replace bulbs.

#### Tail light

- Undo screws «C» securing reflector to tail light; push bulb inwards and turn it to the left at the same time, then slip it off.

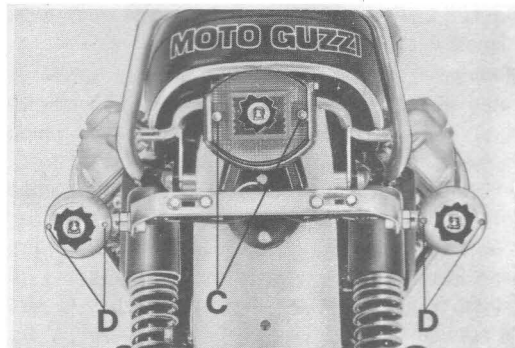
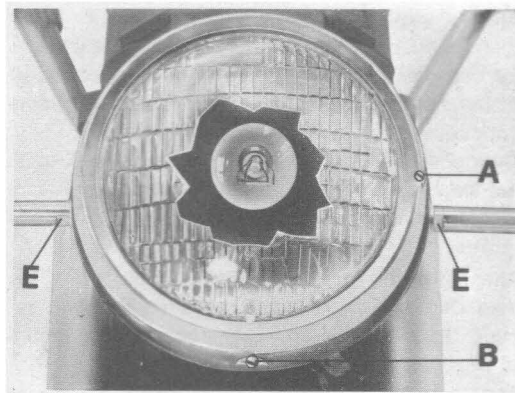



## Turn signals

— Undo screws «D» securing reflectors to signal lights; push bulbs inwards and turn them to the left at the same time, then slip them off.

By re-fitting of reflectors screw in uniformly, do not lock screws too much to prevent braking of same.

## Instrument panel, km and rev. counters

— Slip off bulb sockets and replace bulbs.

**WIRING DIAGRAM (Europe model)**

(fig. 33)

- |  |  |
|--|--|
| 1 - km counter   | 22 - Alternator (14 V - 20 A)            |
| 2 - Rev. counter   | 23 - Starter motor relay                 |
| 3 - High beam indicator light                              | 24 - Starter motor (12 V - 0,7 HP)       |
| 4 - Oil pressure indicator light                           | 25 - Clutch cable cutout                 |
| 5 - Neutral indicator light                                | 26 - Left rear turn signal               |
| 6 - Town driving indicator light                           | 27 - Rear brake stop light               |
| 7 - Generator charge indicator light                       | 28 - Number plate and town driving light |
| 8 - Low beam   | 29 - Right rear turn signal              |
| 9 - High beam  | 30 - Flasher unit                        |
| 10 - Right front turn signal light                         | 31 - Oil pressure cutout                 |
| 11 - Left front turn signal light                          | 32 - Neutral position cutout             |
| 12 - Engine starting and stopping switch                   | 33 - Terminal block with fuses (16 A)    |
| 13 - Lighting switch                                       | 34 - 3-way connector                     |
| 14 - Switch; turn signals, starting, horns, flashing light | 35 - 4-way connector (AMP)               |
| 15 - Horns Power 7 A)                                      | 36 - Contact breaker                     |
| 16 - Front brake stop light cutout                         | 37 - Coils                               |
| 17 - Flashing light relay                                  | 38 - Ignition switch (3 positions)       |
| 18 - Rear brake stop light cutout                          | 39 - 4-way connector (AMP)               |
| 19 - Battery (12 V - 32 Ah)                                | 40 - 2-way connector                     |
| 20 - Regulator   | 41 - Spark plugs                         |
| 21 - Rectifier   | 42 - Town driving light, front           |

- Arancione = Orange
- Bianco = White
- Blu = Blue
- Giallo = Yellow
- Grigio = Grey
- Marrone = Brown
- Nero = Black
- Rosa = Pink
- Rosso = Red
- Verde = Green
- Viola = Violet

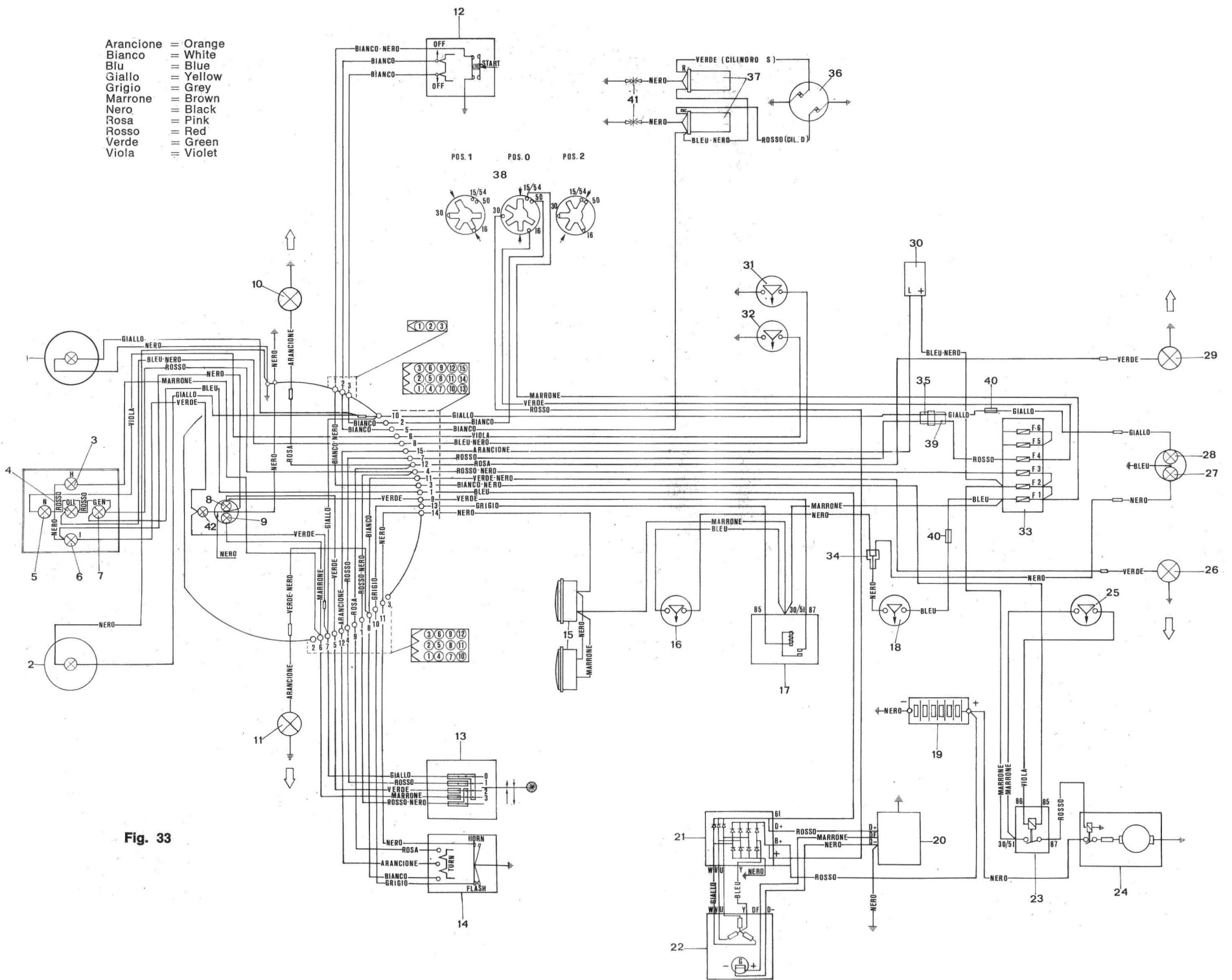

Fig. 33

## LIGHTS (U.S.A. model)

### Headlight

— Sealed beam insert type: 45/40 W - 12 V.

### Tail light

— Number plate lighting parking light and stop light: bulb 5/21 W - 12 V.

Turn signals: 21 W - 12 V.

Indicators, instrument panel: bulb 1,2 W - 12 V.

Indicators, mile and rev. counters: bulb 3 W - 12 V.

### Replacement of bulbs (fig. 34)

#### Tail light

— Undo screws «C» securing reflector to tail light; push bulb inwards and turn it to the left at the same time, then slip it off.

#### Turn signals

— Undo screws «D» securing reflectors to signal lights; push bulbs and turn them to the left at the same time, then slip them off.

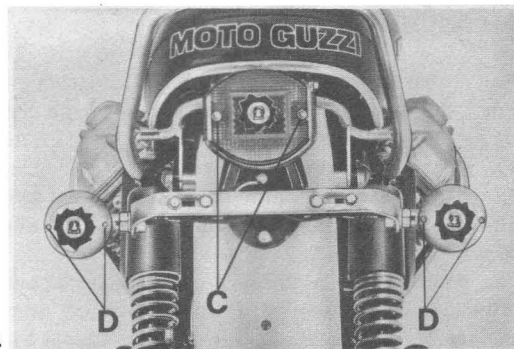
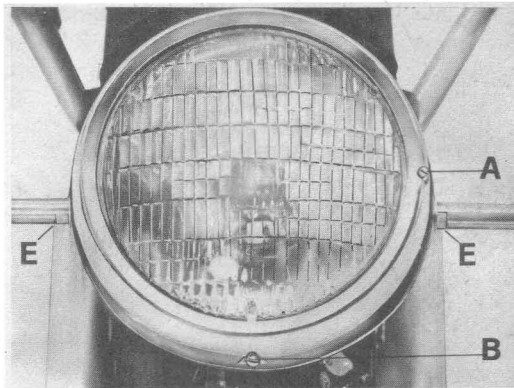

- 55 By re-fitting of reflectors screw in uniformly, do not lock screws too much to prevent braking of same.

## Instruments panel, Mile and rev. counters

— Slip off bulb sockets and replace bulbs.

## Headlight beam adjusting (fig. 34)

For a safe riding and not to trouble crossing riders, the headlight beam has always to be set at a correct height.

For horizontal setting act on screw «A».

For vertical setting undo connections «E» and shift the headlight by hand up or down in order to get the correct height.

The centre of the high beam must not be higher than 0,86 m measured at 3 m distance with motorcycle not on stand and rider on saddle.

## Changing the wiring diagram for vehicles with compulsory lighting on, when starting the engine

To achieve this change it is necessary to take off the wire group which connects connector «35» to fuse n. 4 (red cable) and to connection «40» (yellow cable). This wire group is connected to connector «35» through connector «39».

After disconnecting the yellow cable (rear parking light) from connector «40», connect it to fuse n. 4 as indicated in the wiring diagram.

Connector «35» will be re-fitted, into the insulated housing which supports the flasher unit for turn signals.

This change accomplished, notice that instrument lights and indicator light «I» (Low beam) are not protected by fuse n. 4 but by fuse n. 3.

## WIRING DIAGRAM (U.S.A. model)

56

(fig. 35)

- 1 - Mile counter (bulb 3 W)
- 2 - Rev. counter (bulb 3 W)
- 3 - High beam indicator light (1,2 W)
- 4 - Oil pressure indicator light (1,2 W)
- 5 - Neutral indicator light (1,2 W)
- 6 - Low beam indicator light (1,2 W)
- 7 - Generator charge indicator light (1,2 W)
- 8 - Low beam (40 W)
- 9 - High beam (45 W)
- 10 - Right front turn signal light (21 W)
- 11 - Left front turn signal light (21 W)
- 12 - Engine starting and stopping switch
- 14 - Switch; turn signal, horns, flashing light
- 15 - Horns (power 7 A)
- 16 - Front brake stop light cutout
- 17 - Flashing light relay
- 18 - Rear brake stop light cutout
- 19 - Battery
- 20 - Regulator
- 21 - Rectifier
- 22 - Alternator
- 23 - Starter motor relay
- 24 - Starter motor
- 25 - Clutch cable cutout
- 26 - Left rear turn signal (21 W)
- 27 - Rear brake stop light (21 W)
- 28 - Number plate and parking light (5 W)
- 29 - Right rear turn signal (21 W)
- 30 - Flasher unit
- 31 - Oil pressure cutout
- 32 - Neutral position cutout
- 33 - Terminal block with fuses (16 A)
- 34 - 3-way connector
- 35 - 4-way connector
- 36 - Contact breaker
- 37 - Coils
- 38 - Ignition switch (3 positions)
- 39 - 4-way connector
- 40 - 2-way connector
- 41 - Spark plugs
- 42 - Light switch, with stop device from position «High-Low Beam» to position «Parking light»



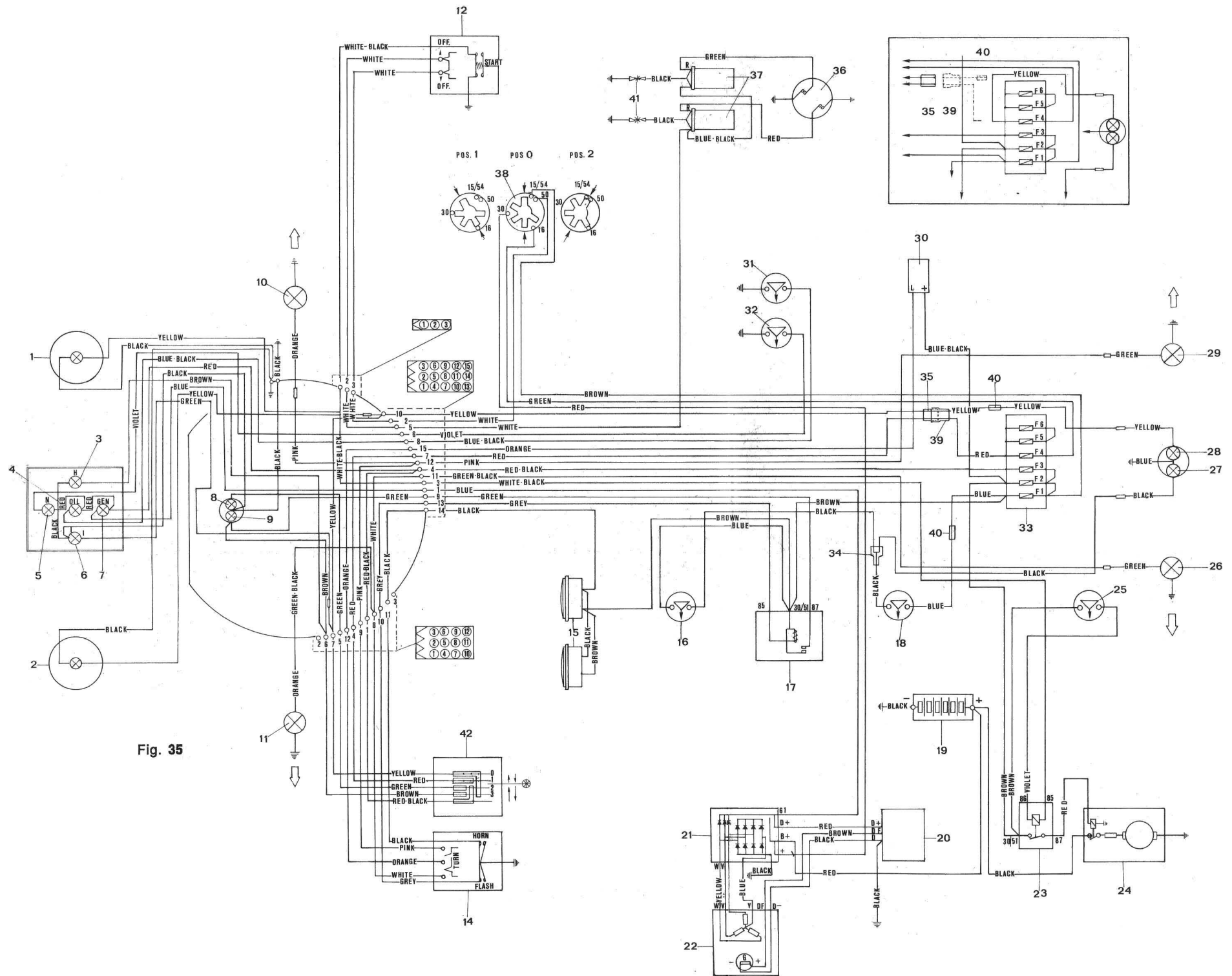

Fig. 35





SEIMM MOTO GUZZI S.p.A. Mandello del Lario

Reg. Imprese N. 2220 Lecco

