

**850 Le Mans**  
**III**

This Manual supplied and scanned by Christian D Smith  
Formatted and edited by Theo Bekkers

**OWNER'S MANUAL**

**The illustrations and descriptions in this booklet are indicative only and the manufacturer reserves itself the right to Introduce any modification It may deem necessary for better performance or for constructive or commercial reasons without prior notice.**

**SEIMM MOTO GUZZI S.p.A. - Technical Publications - Code 2890 0D 51 Printed in Italy -  
'Tecnopress/Bergamc - 1500 - 7-81**



**Dear rider**

**First of all we wish to thank you for choosing this motorcycle of our production.**

**By following the instructions outlined in this manual you will ensure your bike a long and trouble free life.**

**Before riding, please read thoroughly this manual in order to know your motorcycle's features and how to operate it safely.**

**All major checking and overhaul jobs are best carried out by our dealers who have the necessary facilities to quickly and competently repair your Moto Guzzi.**

**Repairs or adjustments by any other than a Guzzi dealer during the warranty period could invalidate the warranty right.**

## **HINTS ON THE PROPER USE OF THIS MOTORCYCLE**

**Due to its exceptionally high feature, this motorcycle can be considered as in the racing machine class and as such has to be ridden in a sportsmanlike way. For this very reason, it has met the favour of many motorcycle fans but, same as for all racing bikes, it has to be used accordingly.**

**For instance, for fuel feed this model is fitted with carburetors with pumps and if the twist grip is not used correctly in accordance with the engine revolutions, there might be an excess of fuel which is ejected by the carburetors, ending in the**

**air filter box of the carburetors same. When travelling at low speed or in other words at low revs, it is necessary for the throttle grip to be used with care since the immission of a greater quantity of fuel might not be fully absorbed by the engine. At high speed, also in case of abrupt accelerations, the fuel is entirely absorbed and used up by the engine, thus eliminating this risk and conferring to this model the brilliant" kicking up» qualities that make it one of its outstanding features.**

**Page four is a Blank Page**

**INDEX**

- 6 Main features**
- 11 Identification data**
- 12 Controls and accessories**
- 14 Instruments and controls**
- 21 Riding Instructions**
- 23 Running in**
- 24 Maintenance and adjustments**
- 31 Removal of wheels**
- 34 Service schedule**
- 36 Lubrications**
- 40 Carburation**
- 43 Valve gearing**

**44 Ignition  
47 Electrical  
equipment**

**MAIN FEATURES**

**6**

<b>Engine</b>	<b>Twin cylinder - 4-stroke</b>	<b>«V»</b>
	<b>Cylinder disposition</b>	<b>90°</b>
	<b>Bore</b>	<b>83 mm</b>
	<b>Stroke</b>	<b>78 mm</b>
	<b>Displacement</b>	<b>844.05 cc</b>
	<b>Compression ratio</b>	<b>9.8</b>
	<b>Max torque</b>	<b>7.6 kgm at 6200 rpm</b>

<b>Valve gearing</b>	<b>O.H.V., push rod operated</b>
<b>Carburation</b>	<b>N. 2 carburetors –Dell-Orto ; type PHF 36 B (D) (right), PHF 36 B(S) (left).</b>
<b>Lubrication</b>	<b>Pressure, by gear pump. Wire gauze and cartridge filters in oil sump. Normal lubrication pressure 3.8-4.2 kg/sqcm (54-60 p.s.i.). Pressure relief valve control in the sump. Oil pressure sender unit in crankcase.</b>
<b>Generator/Alternator</b>	<b>Front, on crankshaft (14 V - 20 A).</b>

<b>Ignition</b>	<p>Coil-battery ignition with double contact breaker and automatic advance.</p> <p>Ignition data:</p> <ul style="list-style-type: none"> <li>- ignition advance (fixed) :8°</li> <li>- automatic advance 26°</li> <li>- full advance (f. + a.) '34'</li> </ul> <p>Contact breaker points gap: 0.37 -0.43 mm (0.014"-0.016")</p> <p>Spark plugs: Bosch W 5 D Lodge 2 HLNY</p>
<b>Starting</b>	<p>Plug points gap: 0.6 mm (.020").</p> <p>2 ignition coils fitted-on the frame.</p> <p>Electric starter (12 V - 0.7 KW) with electromagnetic ratchet control. Ring gear bolted on the fly wheel. Starter button (start) on R/H of handlebar.</p>
<b>Transmission</b>	
<b>Clutch</b>	<p>Twin driven plates, dry type. Hand controlled by lever on left handlebar.</p>
<b>Primary drive</b>	<p>By gears. Ratio: 1.235 to 1 (Z 17/21)</p>





	<p>5 speeds, frontal engagement, constant mesh gears. Cush drive incorporated. Pedal operated on the L/H side of the motorcycle. Gear ratios: Low gear = 1 to 2 (<math>Z = 14/28</math>) 2nd gear = 1 to 1.388 (<math>Z = 18/25</math>) 3rd gear = 1 to 1.047 (<math>Z = 21/22</math>) 4th gear = 1 to 0.869 (<math>Z = 23/20</math>) High gear = 1 to 0.750 (<math>Z = 28/21</math>) By cardan shaft, bevel gear set. Ratio: 4.714 to 1 (<math>Z = 7/33</math>) Overall gear ratios (Engine-wheel): Low gear = 1 to 11.643 2nd gear = 1 to 8.080 3rd gear = 1 to 6.095 4th gear = 1 to 5.059 High gear = 1 to 4.366</p>
Secondary drive	
Frame	Duplex cradle, tubular structure.
Suspension	Front: telescopic fork «MOTO GUZZI make» (patented) with oil pneumatic shock absorbers. Rear: swinging fork and rear dampers with adjustable external springs concentric to the oil pneumatic shock absorbers.
Wheels	Front and rear in light alloy casting with WM 3/2.15 -18" CP2 rims.

<b>Tires</b>	<b>Front:</b> <b>100/90V18</b> <b>Rear:</b> <b>110/90V18</b>
<b>Brakes</b>	<b>Front: disc type with caliper having 4 cylinder controlled by hand lever on right hand side of the motorcycle. Hydraulic transmission independent from the rear brake.</b> <b>Disc size: 300 mm (11.8"), braking cylinder 38 mm (1.49"), master cylinder 12.7 mm (.5").</b> <b>Rear: disc type with fixed caliper with two cylinders. Pedal controlled from the R/H side of the bike. Disc size 242 mm (9.5"), braking cylinder size 38 mm (1.496"), master cylinder 15.875 mm (.624").</b> <b>The rear brake is connected by an hydraulic transmission to a second brake on the front wheel having the same features and size as the hand controlled front brake.</b>
<b>Dimensions and weights</b>	<b>Wheelbase (loaded) 1.505 m (59")</b> <b>Length 2.190 m (86")</b> <b>Width 0.640 m (25")</b> <b>Height 1.160 m (46")</b> <b>Ground clearance 0.175 m (6.9")</b> <b>Dry weight abt. 206 kg (454 lbs).</b>

## 10 Performances

Top speed, solo riding 230 km/h (114 mph).  
Fuel consumption: 5.7 l x-100 km

### Fuel and oil capacities

Group or part	Quantity	Recommendation
Fuel tank Reserve	251 (6.15 US gls) 3 l (3' quarts)	Supergrade petrol (98/100 NO-RM)
Oil sump	3 l (3' quarts)	Agip Sin! 2000 SAE IOW/50 oil
Gear box	0.750 l (10' pints)	Agip F.1 Rotra MP SAE 90 oil
Rear drive box (bevel set lubrication)	0.250 l (abt, 9 oz) of which 0.230 l (abt. 8 v. oz) 0.020 l ('l. oz]	Agip F.1 Rotra MP SAE 90 oil Agip Rocol ASO/R oil
Front fork (each leg)	0.060 l (abt. 2 oz)	Agip F.I ATF Dexron fluid
Braking circuits (front and rear)		Agip F.I Brake fluid SAE J1703

## IDENTIFICATION DATA (fig. 2)

Each motorcycle is identified by an identification number on the frame downtube and on the engine crankcase.

The identification number on the frame is mentioned in the motorcycle log-book and identifies the vehicle to all legal effects.



:

## Spare parts

In case of part replacements, ensure that <<original Moto Guzzi spare parts>> only are used.

The use of non-genuine parts invalidates every warranty right.

## Warranty

The warranty is valid for a period of six months with a limitation to 1 0.000 km (6000 miles) from the selling date and expires in case of modifications to the motorcycle, participation to racing events or use of not original accessories, or original accessories which are fitted not following SEIMM - MOTO GUZZI directions.

Tires, accessories, or parts not manufactured in the « Seimm Moto Guzzi I) factories are excluded from this guarantee.

Each new motorcycle is supplied with a «voucher book» which has to be kept carefully with all other circulation papers as it is the only document entitling the owner to request warranty service from the Seimm - Moto Guzzi dealers, according to the general conditions of sale,

## 12 CONTROLS AND ACCESSORIES

(fig. 3)

v

- |    |   |    |                              |
|----|---|----|------------------------------|
| 1  | Front turn light signals.                         | 14 | Voltmeter.                   |
| 2  | Right front brake control lever.                  | 15 | Rev-counter.                 |
| 3  | Throttle control grip.                            | 16 | Lock set, fuel cap opening.  |
| 4  | Speedometer.                                      | 17 | Gearshift pedal.             |
| 5  | Ignition key.                                     | 18 | Footrest, pillion.           |
| 6  | Left front brake and rear brake pedal.            | 19 | Rear turn signal indicators. |
| 7  | Footrest.   |    |                              |
| 8  | Master cylinder, left front brake and rear brake. |    |                              |
| 9  | Saddle release lever.                             |    |                              |
| 10 | Tail light.                                       |    |                              |
| 11 | Headlight.  |    |                              |
| 12 | Panel board.                                      |    |                              |
| 13 | Clutch lever.                                     |    |                              |

•"Right" or "left" in the text are intended as seen by the rider astride the motorcycle.

;

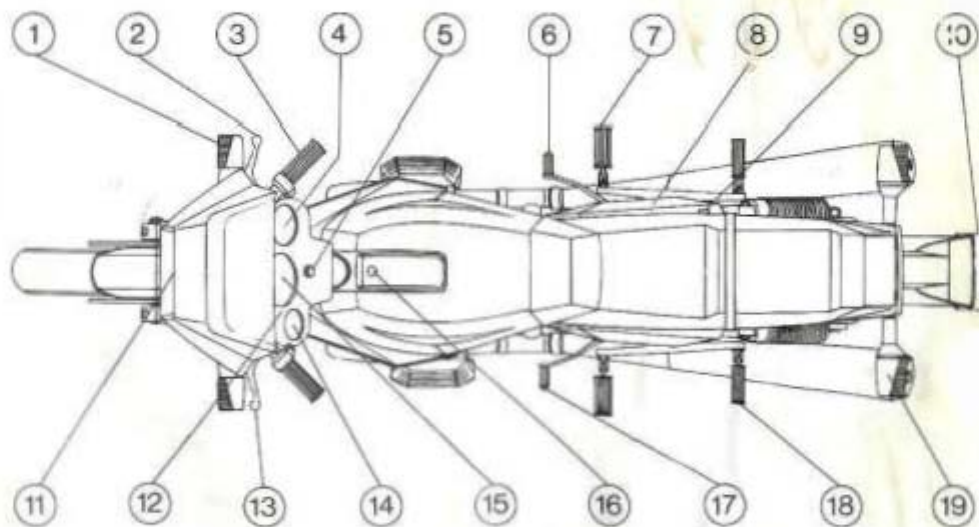

## 14 INSTRUMENTS AND CONTROLS

### Instrument Panel

1 Voltmeter.

2 Rev-counter.

3 Speedometer, km  
or miles.

4 Ignition key:

«OFF" In line with mark " C »;  
machine stationary, key  
removable (no contacts).

<<A>> In line with mark "C"  
(turned clockwise):



machine ready to be started. All  
circuits «ON ». Key not removable.

<<B>> In line with mark -O» (turned  
clockwise): machine at standstill.  
With switch " A" (fig. 5) in "PARK"  
position, parking light" ON », Key  
removable.

5 Warning light (green) left turn signal.

6 Warning light (green), "Neutral»  
indicator. Lights up only when the  
gearbox is in neutral.

7 Warning light (red), indicating current  
delivery from generator. Should go out  
when the engine has reached a certain  
number of revolutions.

8 Warning light (red), oil pressure gauge.  
Goes out when oil pressure is sufficient for  
normal engine lubrication. If it does not, this  
means oil pressure is not correct and in such  
an event the engine should be immediately  
stopped and all circuits checked over.

9 Warning light (red) indicating low level of  
oil in the reservoir-master cylinder for the  
front left and rear brakes. When this light  
comes on, top up the fluid reservoir,  
ensuring there are no leakages in  
the hydraulic circuit.

**10 Warning light (blue) indicating high beam on.**  
**11 Warning light (green) indicating parking lights on.**

**12 Warning light (green), right turn signal.**

**13 Switch for emergency flashers (fitted on headlight support).**

**14 Zero reset for odometer.**

**Light switches (on left hand side of handlebar) (fig. 5)**

**Switch «A»**

- **PARK" Parking lights.**
- «ON.. Ignition dual beam lamp.
- **OFF.. Lights off.**

**Switch •• B ••**

**With switch •• A •• in position ON:**

- «LO.. Low beam.
- «HI" High beam.

**Horn, flashing lights and turn signal buttons (fig. 5)**

**Are fitted on the LIH side of the handlebar. •• D" (horn) Horn control.**

**"c" (flash) Flashing light control Switch <<E>>  
 <<R>> Right turn  
 <<L>> Left turn**

**Engine starting and stopping button (fig. 6)**

**It is located on the right handlebar.**

**With key mark •• A" in line with mark •• C» (fig. 4), the vehicle is ready to be started.**

**To start the engine, proceed as follows:**

- **Ensure switch •• B" is in position •• RUN"**
- **Pull the clutch lever completely .**
- **On a cold engine, adjust starter lever to position**

**.A •• (fig. 28) .**

**- Press start button" A".**

**To stop the engine in an emergency: - Move switch" B" to position" OFF".**

**As soon as the engine stops, turn ignition key (fig. 4) counterclockwise till mark «OFF" is in line with mark •• C", and take out the key from the lockset.**

**Starter lever (fig. 28)**

**This lever for cold starting is located on the left side of the vehicle .**



16 - «A" Start position.  
- "B" Riding position.

Throttle twist grip control («G» in fig. 6) It is located on the right hand side of the handlebar: turning it inwards opens the gas and vice versa closes it.

To adjust the stroke of the throttle grip action screw "0,,.

To harden the return of the throttle grip act on screw "C".

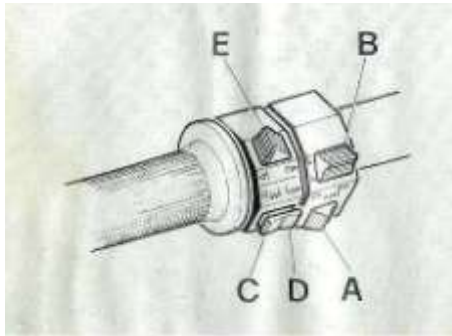

### Clutch control lever

It is on the left hand side of the handlebar and it should be pulled only for starting and gearshifting.

### Control lever for R/H front brake («H" in fig. 6)

It is on the R/H handlebar and controls the master cylinder for the hydraulic front brake through a suitable circuit.

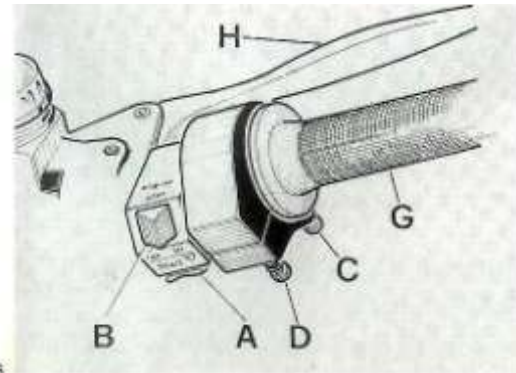

### Left front and rear brake control pedal (.F. in fig. 18)

It is centrally located on the R/H side of the vehicle and it is link connected to the master cylinder. It controls the left front brake and rear brakes simultaneously.

### Gearbox control pedal (fig. 7)

This pedal is centrally located on the LH side of the bike.

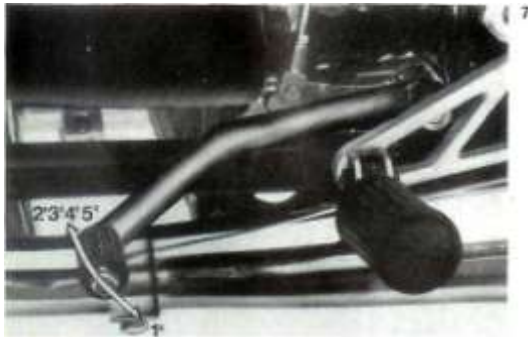

### Positions:

17

- low gear, lever end towards the ground
  - 2nd, 3rd, 4th and high gear lever to upward
  - neutral between low and 2nd gear
- Before actuating this pedal, be sure the clutch lever is pulled completely.*

### Fuel filler cap (fig. 8)

To access filler cap «B» it is necessary to turn key «A» clockwise on the protection cover, then the cover can be raised.

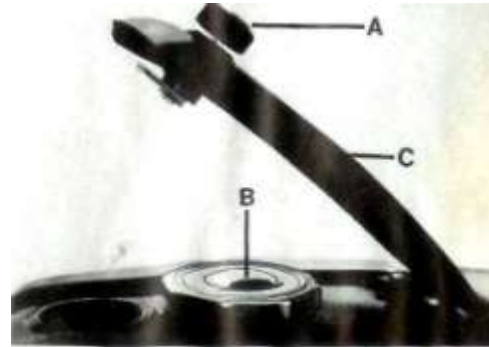

## 18 Fuel taps (fig. g)

Are fitted under the tank, rear side.

The fuel tap has 3 positions:

**ON** Open, lever arrow upwards .  
**RES** Reserve, lever arrow downwards.  
**OFF** Closed, arrow on lever horizontal.

## Terminal block with fuses (fig. 10)

It is located on the right side of the motorcycle. To access it: raise the saddle, remove the right side cover, and the block cover.

N. 6 fuses of 16 A are fitted.



## Fuse n. 1

Starter relay - Rear stop switch.

## Fuse n. 2

Flashing light - Horn

## Fuse n. 3

Warning lights: (neutral - gen - oil - brake fluid high beam) - voltmeter - front stop switch - high beam - low beam.

## Fuse n. 4

Parking lights - Parking lights indicator - Panel lights.

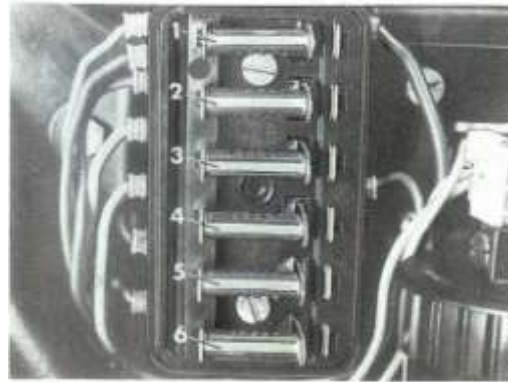

**Fuse n. 5**

Turn signal lights and their warning lights.

**Fuse n. 6**

Available

Saddle lifting device (fig. 11)

Withdraw securing pin from the right, remove grab strap "A" and push lever «B» forward.

Steering lock («A» of fig. 12)

To lock or unlock the steering, proceed as follows:

**Locking**

19

- Turn the handlebar fully to the right.
- Insert the key in the lock set, turn it anti 'clockwise, push it right in, release it and slip it out.

**Unlocking**

- Insert the key in the lock set, turn it Counterclockwise, release it, and withdraw it.

**Side Stand**

This stand is used only for brief stops. Since it is automatically retractable, for long stops it is advisable

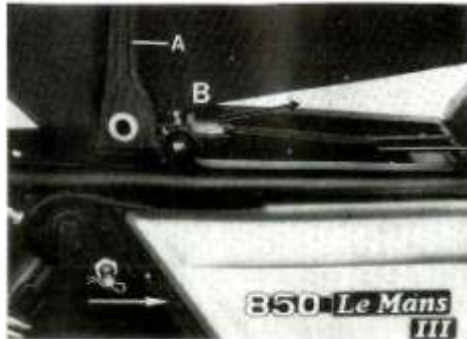

11



12

- 20 to always use the centre stand which guarantees better stability

### Steering damper *R/Hs*

It is fitted on the R/H side of the motorcycle, between frame and bottom yoke.

To harden or slacken the damper, screw in or out nut **A**

### Cleaning the windshield

Any type of soap, cleansing agent, polish or polishing

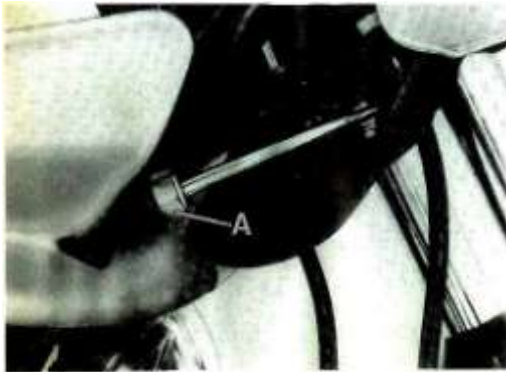

wax normally used to clean plastic or Glass materials can be utilized.

However, the following precautions should be taken:

- Never wash or clean the windshield when the external temperature is very high or after exposure to the sun.
- Under no circumstances, solvents, lyes, or similar products should be used.
- Do not use liquids containing abrasive materials, pumice powder, emery paper, scrapers, or suchlike.
- Before polishing ensure all dust and impurities are removed by washing.
- Light scratches can be smoothed out with light polish.
- Fresh paint or sealing compounds, when still wet, can easily be removed by lightly rubbing off with isopropyl alcohol, soluble mineral oil, butyl or cellosolve. (Never use methyl alcohol).
- Use a soft sponge or cloth chamois leather or cottonwool, rubbing lightly. '
- Never use paper towels, synthetic fiber clothes which may scratch the windshield surface. Vigorous rubbing or solvents will not remove deep scratches or nicks.

## RIDING INSTRUCTIONS

### Controls before starting

Ensure that:

- the ignition key is in the start position (mark- A) on the key has to be in line with mark « C » (fig. 4); - there is sufficient fuel in the tank;
  - red warning light on panel (fuel level in reservoir for the front left and rear brakes) is not lighted; - the oil in the sump is at correct level;
  - the following warning lights are lit: «oil», «gen» (red) and for night time riding (green):
  - starter control lever for cold starting is in position «A» fig. 28.
- ### Starting a cold engine

After checking the above, turn the twist grip 1/4 turn, pull the clutch lever fully and press start button (fig. 6).

As soon as the engine has started and before returning starter lever to position «8» (fig. 28), *allow the engine to idle a few minutes in the cold season or a few seconds in the hot season.*

If the starter Lever is left starting position A fig. 28 whilst riding there would be irregular carburation and increased fuel consumption and in the worst cases the cylinders might seize because of too much petrol going into them. *Caution* - If the green light "Neutral" on the panel does not light up when mark "A" on the ignition key is lined up with mark "C" (see fig. 4), this means a gear is engaged and the pedal has to be moved to the neutral position.

21

### Starting a hot engine

Proceed as for a cold engine, except that in this case the starter lever has not to be adjusted to start position "A" fig. 28 as this would richen the carburation too much.

### On the way

To change up or down, pull the clutch lever completely and engage the next gear. Release the clutch lever slowly, accelerating at the same time. The pedal has to be actuated firmly and accompanied with the foot.

When shifting down to lower gears, operate gradually the brakes and the throttle grip to avoid racing the engine when the clutch lever is released

### Stopping the motorcycle

Close the throttle, actuate the brakes gently, and pull the clutch lever only when the bike is almost to a standstill. This operation has to be done with much coordination in order to keep the vehicle under control.

To reduce the speed gradually by properly using the gearbox with a view to utilize the engine braking power, do this very carefully in order not to cause the engine to over-rev.

On wet or slippery roads, the brakes - especially the front one on the right - should be used with great caution.

To stop the engine, turn the ignition key mark OFF. to line it up with mark "C. (fig. 4).

Do not forget to always close the fuel taps on a stationary engine.

### Parking

When parking at night on insufficiently lighted roads, switch on the parking lights by turning the

key (fig. 4) till mark «S» on it is in line with mark «C» and light switch in fig. 5 is in position «PARK». Then remove the key and lock the steering

## RUNNING IN

During the running in period follow strictly these recommendations:

1 Before starting allow the engine to warm up at idling speed for a more or less period of time, according to the external temperature.

2 Avoid exceeding the maximum permissible speeds in each gear. Avoid running at the same number of revolutions for long periods but change gear frequently.

3 Before stopping reduce the speed gradually to prevent the various engine groups from undergoing abrupt changes of temperature.

4 Ensure all operations specified in the service voucher have been carried out at the stated milages.

5 Don't forget that proper bedding down of all components will only occur after several thousands of miles have been covered.

This will allow you to obtain excellent performance from your motorcycle for a long period of time.

### MAXIMUM RUNNING IN SPEEDS

Distance covered	Maximum permissible speeds				
	Low gear	2nd gear	3rd gear	4th gear	high gear
Up to 1000 (600 miles)	45 km (29 mph)	65 km (40 mph)	85 km (53 mph)	100 km (63 mph)	115 km (72 mph)
From 1000 km (600 to 2000 km (1200	55 km (34	80 km (48 mph)	105 km (63 mph)	120 km (74 mph)	140 km (87 mph)
From 2000 km (1200 to 4000 km (2400	Gradu increase the above limits up to the speed				

After the first 500 km (300 miles) - 1500 km (900 miles)  
 • Change the crankcase oil.

Should the level fall under the minimum mark before the engine has covered 500-1000 km

(300-600 miles), it will be necessary to change the oil instead of topping up.

Recommended oil: Agip Sint 2000 SAE 10W/50.

- Check tightness of all nuts and bolts.
- Adjust rocker clearance.
- Check contact breakers gap.



## 24 MAINTENANCE AND ADJUSTMENTS

### Adjusting the clutch control lever (fig 14)

If the free play at the handlebar is more or less than 3'74 mm (.157"), act on adjuster "A" to restore the correct play.

This adjustment can also be carried out by slackening counternuts «C» on the right side of the gear box and acting on adjuster "B".

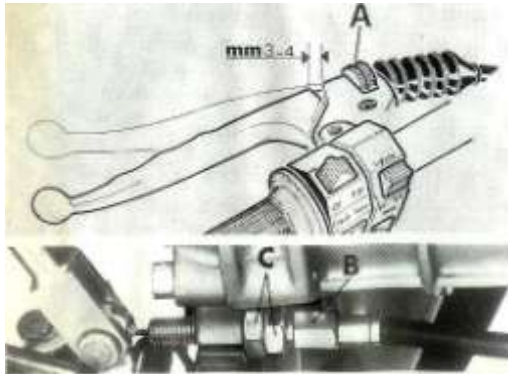

### Adjusting the right front brake control lever (fig. 15)

Proceed as follows:

- insert feeler gauge "A" between the floater in the master cylinder and the control lever end and turn thumb screw "All to obtain the correct play which is 0.05 + 0.15 mm (0.0019 + .0059").

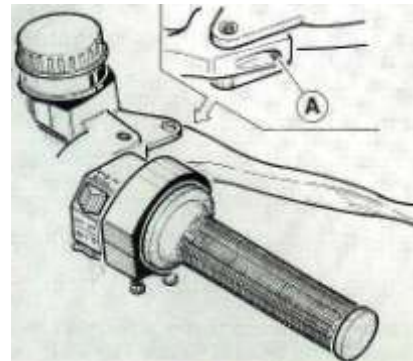

## Checking wear of the brake pads

Every 5000 km (3000 miles). check thickness of the brake pads.

- New pad 9 mm (.3543").
- Wear limit 6 mm (.2362").

If the pad is worn down to more than this limit, it is necessary to change the pads.

After this operation has been carried out, there is no need to drain the air from the braking circuits: it is sufficient to operate the control lever on the handlebar -B» (in fig. 16) several times until the caliper pistons reach their normal position.

When replacing the pads, check also the condition of the fluid line and replace them immediately if damaged.

*N.B. - When replacing the pads it is advisable, for the first 100 km, to act on the brakes carefully to allow a correct setting of the pads same.*

Checking the braking discs («1<< in fig. 16 and 17)

The brake discs should be perfectly clean, without oil, grease or other impurity, also free from deep scoring.

When a disc is replaced or overhauled, it is necessary to check the "floating". This control is done by

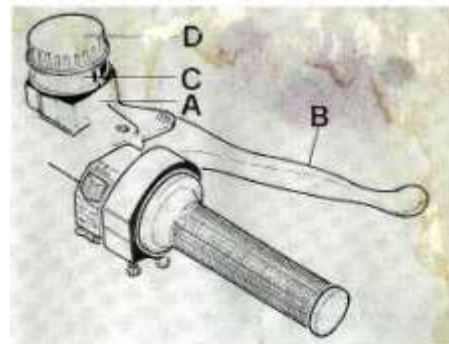

the aid of a suitable gauge and the reading should in no case exceed 0.2 mm (.0079"). If this «floating» is higher, it is well to ensure that the discs are properly assembled on the hubs, also the hub bearings play. The disc securing screws are tightened with a torque wrench set to 2.2 + 2.4 kgm (16 + 18 ft/lbs).

**Controlling the fluid level and replacing the brake fluid in the reservoirs (master cylinders) (fig. 16-17)**

For proper braking operation, these instructions should be followed strictly:

1 Periodically check the fluid level in the reservoirs. This level should always be over transparent section «C» of the reservoir (master cylinder).

2 Periodically check and, if necessary, top up the fluid in the reservoir "A", after undoing nut «0» and removing the diaphragm (see fig. 16).

The fluid level in the reservoir for the left front and rear brakes is indicated by a warning light "9", in fig. 4 on the instrument panel.

To top up, undo cap "C" on master cylinder "A", after disconnecting all electric wires (fig. 17). Use only fluid taken from original containers, opened just before pouring in.

3 Every 5.000 km (9000 miles) or at least once a

year, change the braking fluid. For good operation of the circuits, it is necessary for the ducts to be always full with airless fluid. A long and elastic movement of the control lever "8", indicates the presence of air bubbles in the ducts. To wash the circuits, use only fresh fluid.

Never use alcohol for washing or compressed air for drying. For metal parts, the use of trichloroethylene is recommended.

Fluid to be used: Agip F.1 Brake Fluid SAEJ 1703.

**Bleeding the air from the braking circuits (fig. 16 and 17)**

This operation is required when the movement of the control lever on the handlebar or the pedal is long and elastic, due to the presence of air in the braking circuits.

To bleed, proceed as follows:

Right front brake circuit (fig. 16)

- Turn the handlebar till the reservoir ("A") is in the horizontal position.
- If necessary, fill up reservoir «A». Ensure that during the bleeding operation the fluid does not drop below the transparent section.

• Bleed by acting on caliper "F" as follows:

1 Remove rubber covers and fit flexible pipe "G" on drain plugs "E" with the other end of the pipe plunged in a transparent container "H" partially filled up with liquid of the same type.

2 Loosen drain plug «E»,

3 Completely pull brake lever «8" several times, releasing it slowly and waiting a few minutes before pulling it again.

Repeat this operation until the pipe end in the transparent container emits airless fluid.

4 Keep control lever "B. fully pulled and lock up

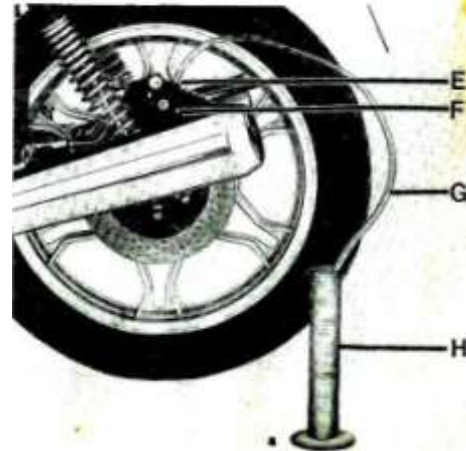
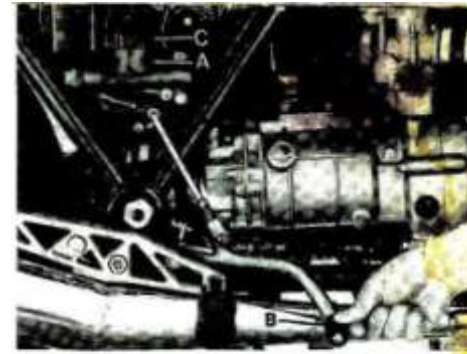
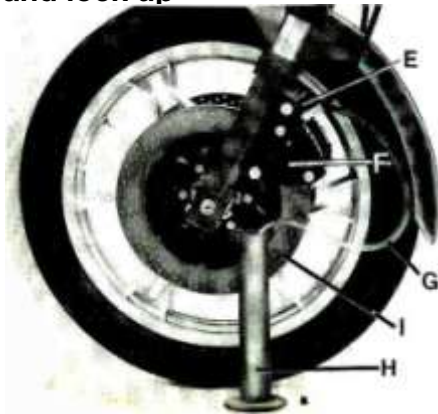

- 28 plug «E». remove plastic duct «G», and re-fit rubber cover on the drain plug. If the air bleeding operation has been carried out correctly, a direct and efficient working of the fluid will be perceived immediately after the initial idle movement of control lever «8». If not repeat the operation until the above result is achieved

#### Front left and rear brake circuit (fig. 17)

For this proceed as described in chapters «controlling the fluid level and replacing the brake fluid

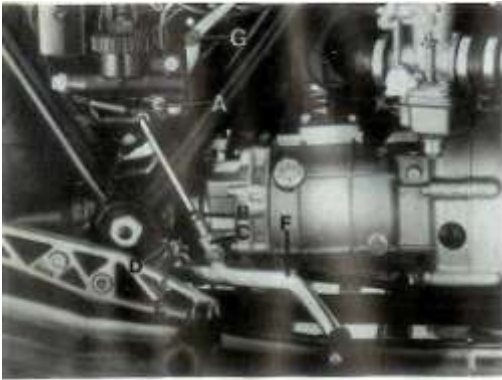

in the reservoirs-master cylinders», except point «1» and in «right front brake circuit», except points 3-4 which are replaced by:

#### Level

1 The level is warned by indicator «9» of fig. 4 on the panel. When this lights up, top up.

#### Bleeding

3 Press down control pedal «S» etc.

4 Keep control pedal fully pressed down etc.

#### Adjusting the front left and rear pedal position (fig. 18)

Check clearance between floater and control lever «8», proceeding as follows:

- Fit feeler gauge «G» between the master cylinder floater and the control lever end. Then operate on thumb screw "A" to obtain the correct play which is 0.05 ~ 0.15 (.0019 ~ .0059").

- If the clearance is not correct, take out the split pin, remove the pin, slacken counter nut «B», and screw in or out fork "C" until control pedal "F" comes to the desired position.

Refit the rod retaining pin and the split pin. At the end of this operation, slacken counter nut «E» and adjust screw «0» for lever return.

### Adjusting the rear suspension with oil pneumatic dampers (fig. 19)

The external springs of the rear dampers can be adjusted to five different positions by means of lever «A» in the kit.

Should an irregular operation of the hydraulic dampers be noticed, it is advisable to have them checked in one of our dealers workshops.

*Note - Do not forget that both suspensions have to be adjusted to the same position to assure good stability to the motorcycle.'*



The operating load pressures of these shock absorbers are the following:

- front: 3 kg/sqcm  $\pm$  1
- rear: 4 kg/sqcm  $\pm$  1

To check the pressure it is advisable to use a Pressure gauge having a very short pipe (better if any), as the capacity of the pipe may affect the pressure existing inside the shock absorbers.

To ascertain to which extent your pressure gauge reduces, when taking the measurement, the pressure inside the shock absorber it is sufficient to carry out two consecutive measurements: the difference between the two readings gives approximately the pressure reduction occurring whenever a measurement is taken.

The measurement must be taken with the bike on the central stand and with cold shock absorbers; to charge the shock absorbers only use moisture less air.

### Adjusting the steering (fig. 20)

For safe riding, the steering has to be adjusted so as to allow free movement to the handlebar but without play. To correctly adjust, proceed as follows:

- Loosen steering head fixing bolt "A"

### 30 "Adjusting steering head nut «8».

Screw in or out adjuster screw «C» to take up play

This done tighten nut "B" and steering head fixing bolt "A"

*If is well for this operation to be carried out by one of our dealers.*





## REMOVAL OF WHEELS

1.

### Front wheel (fig. 21)

To remove the front wheel, proceed as follows:

- Set the vehicle up on the center stand and place a stand under the engine crankcase to keep the wheel up from the ground.

- Undo screws «A» securing the caliper to the right fork cover and from this remove caliper «S» complete with its piping.
- Undo the spindle securing nut «C» on the UH side.
- Undo the screws «E» securing the fork covers to wheel spindle.
- Withdraw spindle «f» paying attention to the mounting position of spacers «0» and «G».
- Take out the braking disc (on the right side of the wheel) from the caliper fitted on the R/H fork cover. Take off the wheel from the fork legs. The reassembly operation is a reversal of the dismantling one.

### Rear wheel (fig. 22)

To remove the rear wheel from the swing arm and the drive box, proceed as follows:

- Set up the bike on the center stand.<sup>31</sup>
- Undo nut «A» with washer «B» on the spindle *rear* drive box side.
- Loosen spindle bolt "0,, on fork arm.
- Withdraw spindle «E» from the drive box, the hub, and the swing arm.
- Take out braking disc from caliper "E"
- Remove the plate assembly fitting the caliper from the stop pin on the swing arm, securing this group to the frame.

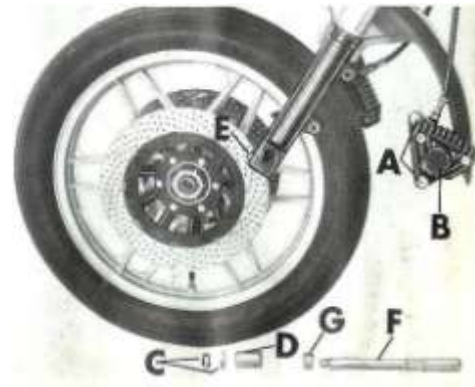



- 32 **Lean the vehicle to the right just sufficiently to allow the wheel to be withdrawn from the rear fork arm and the rear drive box.**

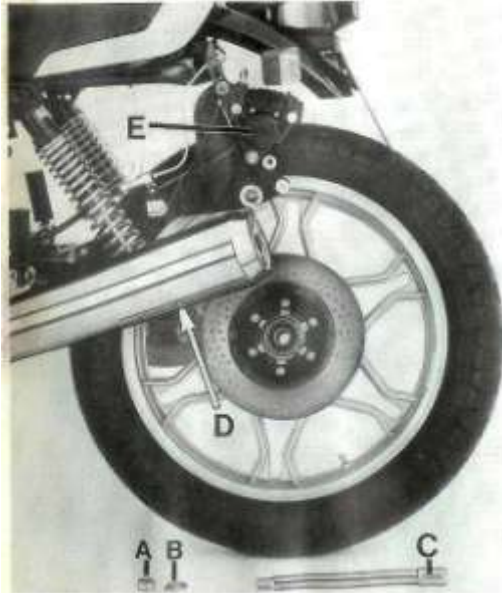

*To re-assemble, reverse the dismantling sequence, remembering to insert the plate complete with caliper on the stop lug on the left arm of the swing fork.*

### Wheel balancing

To improve the vehicle stability and reduce vibrations at high speed, the wheels have to be kept in a perfectly balanced condition.

To balance a wheel, proceed as follows:

- Remove the wheel and set it up on a forked stand.
- Spin the wheel slowly several times and watch if it always stops in different positions, thus indicating a correct balance.
- If one point of the wheel always stops at the bottom, put a balancing weight opposite this point.
- Repeat the operation till the wheel is correctly balanced.

### Tires

These are included in the motorcycle components that have to be kept under control very carefully as the vehicle stability, riding comfort, and sometimes even the rider's safety are dependent on them. Therefore it is unadvisable to use tire having less than 2 mm (1/16") thickness tread.

An incorrect tire pressure may also affect the vehicle stability and cause rapid wear of the tire. Recommended pressures are:

- Front wheel with one or two persons: 2.1 kg/sqcm (29 p.s.i.).
- Rear Wheel: solo riding 2.4 kg/sqcm (34 p.s.i.); with pillion: 2.6 kg/sqcm (37 p.s.i.).

The above speeds are for normal riding (cruising speed). If using the motorcycle at constant high speed or on highways, it is recommended to increase the pressure by 0.2 kg/sqcm (3 p.s.i.).

#### Removing and re-fitting tires on the rims

This model fits light alloy cast rims which offer quite high mechanical resistance but are liable to get damaged from an aesthetic and functional aspect when improper tooling is used for the removing and re-fitting operations.

Under these circumstances, never use tools that have ribbings or sharp edges on the sides contacting the rims.

The contacting surface of such rims has to be very wide, smooth, and with rounded edges. The use of any of the lubricants available on the market for these purposes will greatly facilitate tire sliding and settling of tire on the rim, preventing also overloads on the tools.

It is also very important for the tire bead to be properly entered into the center rim groove.

Tires that have an arrow on their sides have to be fitted in the following way:

- Rear wheel, with the arrow turned in the riding direction.
- Front wheel, with arrow turned against the riding direction.

### 34 SERVICE SCHEDULE

ITEMS	MILEAGE COVERED	900mi. (1500 km)	1800 mi. (3000 km)	3700mi. (6000 km)	5600 mi. (9000 km)
• Engine oil		R	R	R	R
• Oil filter		R			
• Wire gauze oil		C			
• Air filter				C	R
• Ignition timing		A	A	A	A
• Spark plugs		A	A	A	R
• Rocker		A	A	A	A
• Carburetion		A	A	A	A
• Nuts and bolts		A			
• Fuel tank, filters and pipes					C
Gear box oil		A	A	A	R
Rear drive box		A	A	A	R
Wheel and steering bearings					
Fork legs oil					
Starter motor and					
Brake systems		A	A	A	A
Brake pads		A	A	A	A

**A = Inspections - Adjustments \_ Possible replacements \_ Servicing / C = Cleanings / R = Replacements. • Operation required for maintaining the vehicle according to emission regulations (USA).**

**Occasionally, check the electrolyte level in battery, lubricate joints and cables; every 500 km (300 miles) check the engine oil level. In any case, renew this oil at least once a year.**

7500 mi. (12.000	9400 mi. (15.000	11.300 mi. (18.000	13.200 mi. (21.000 km	15.100 mi. (24.000 km	17.000 mi. (27.000 km	18.9000 mi. (30.000km)
R	R R C	R	R	R	R	R R C
	C	R			R	
A	, A	A	A	A	A	A
A	A	R	A	A	R	A
A	A	A	A	A	A	A
A	A	A	A	A	A	A
	^					A
		C			C	
A	A	R	A	A	R	A
A	A	R	A	A	R	A
			A			
			R			
			A			
A	R	A	A	A	A	R
A	A	A	A	A	A	A

## 36 LUBRICATIONS

### Engine Lubrication

#### Checking the oil level

Every 500 km (300 miles) check level of oil in crankcase.

Correct level is in proximity of the top mark in dipstick "A"

If lower, top up with oil of same quality and density.

This control has to be made after the engine has run for a few minutes and with the cap-dipstick "A" fully screwed in.

2.

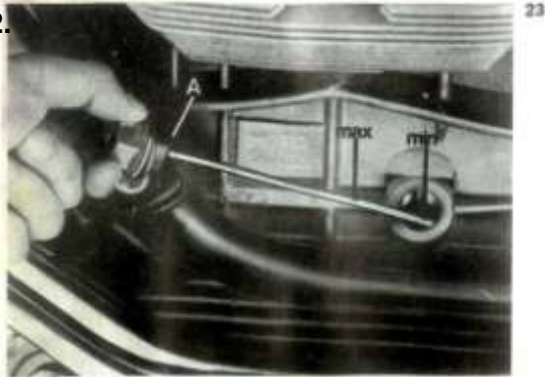

### Replacing the oil

After the first 500-1000 km (300-600 miles) and later on every 3000 km (2000 miles) or so, replace the oil in the crankcase. This operation is done on a warm engine, allowing the old oil to drain completely before introducing fresh one.

"A" Oil filler cap (fig. 23).

"B" Oil drain cap (fig. 24).

Quantity required: 3 l of Agip Sint 2000 SAE 10W/50.

24

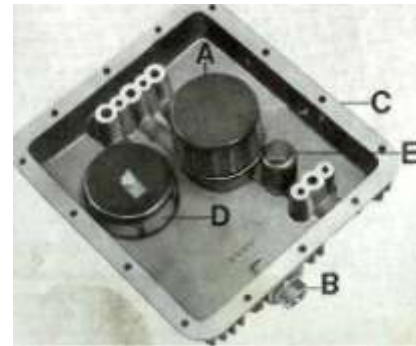

Replacing the oil filter cartridge and cleaning the wire gauze filter (fig. 24)

Every 15.000 km (9000 miles or 5 oil chances), replace filter cartridge «A» proceeding as follows:

- Undo cap «B» and let the oil drain fully.
- Undo the sump securing screws and remove sump «C» from the crankcase complete with filter cartridge «A», wire gauze filter «0» and oil pressure relief valve «E»
- Undo filter cartridge «A» and replace with an original one.

When replacing filter cartridge «A» it is well to also remove wire gauze filter «0», washing it in a petrol bath and drying it with a compressed air jet. Before re-fitting it, blow through the oil ducts in the sump with compressed air.

Finally, do not forget to always replace the sump gasket.

*It is advisable to have this operation carried out by Our dealers.*

Lubrication of the gearbox (fig. 25)

Checking the oil level

Every 3000 km (2000 miles) check that the level is skimming the top of the inspection hole plug «B»

If lower top up with oil of same quality and density.

Replacing the oil

37

Every 10.000 km (6000 miles), replace the oil in the gearbox. This operation has to be done on a warm engine when the oil is more fluid and easy to drain.

Do not forget to allow all the old oil to drain completely, before adding fresh one.

«A» Filler cap.

«6» Level checking plug. «G» Oil drain plug.

Quantity required: 0.750 l (about 25 oz.) of Agip F. 1 Rotra MP SAE 90.

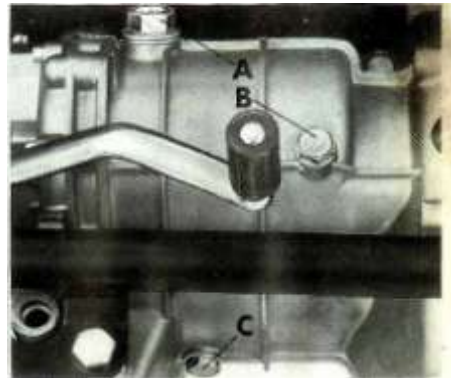

26

## 38 Lubrication of the rear drive box (fig. 26)

### Checking the oil level

Every 3000 km (2000 miles), check that the oil level is nearly skimming top level cap «A». If lower, top up with oil of same quality and density.

### Oil change

Every 10.000 km (6000 miles) or so, change the oil in the rear drive box.

Do this on a warm engine as the oil is more easily drained.

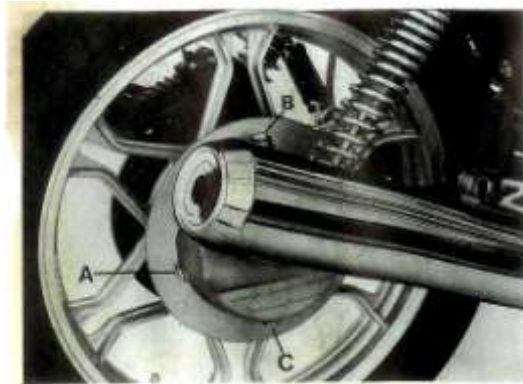

To replace the oil in the front fork legs, proceed as follows:

- with the bike on the central stand, loosen the side screw "C" locking the steering head to the fork arm; disconnect compensating pipe and completely unscrew the hexagonal screw plug "B" then undo drain plug «A»;
- slightly press the front part of the bike to force out the plug «B» which is solidal to the shock absorber. Do this paying attention not to damage the instruments panel;
- refit plug «A» and introduce the quantity of fluid necessary (60 cc Agip F.1 ATF Dexron) through the space existing between the inner diameter of the fork arm and the shock absorber body;
- release the front part of the bike, refit plug «8»

## Front fork lubrication (fig. 27)

Let the old oil drain completely before adding fresh one.

“A” Level plug.

“B” Filler plug.

“C” Drain plug.

Quantity required: abl. 0.250 l of which 0.230 l (3/4 pints) of Agip F.1 Rotra MP SAE 90 and 0.020 l (approx. 1/4 oz.) of Agip Rocol ASO/R.

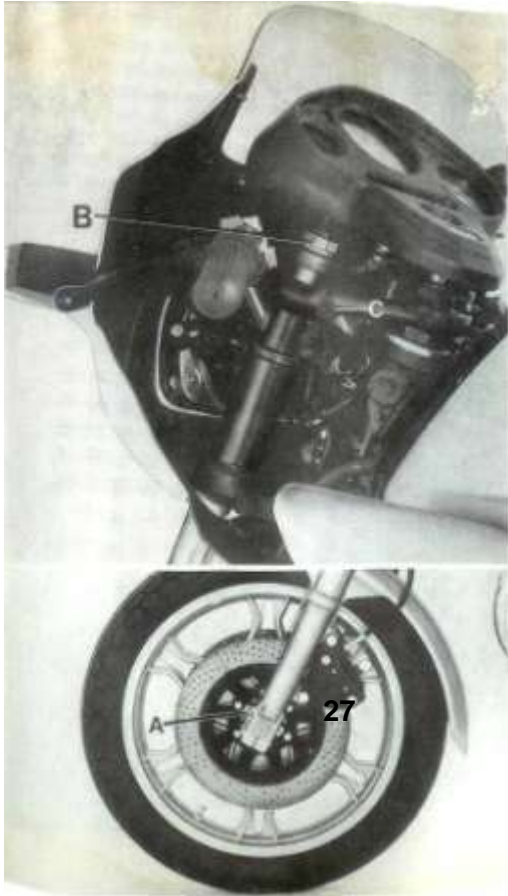

3. 39

and lock the side screw. Repeat the same operation for the other fork leg;

- reconnect compensating pipe and check the pressures keeping to the given values.

Lubrication of the steering and rear \ fork bearings

These operations are best carried out by our dealers.



## 40 CARBURATION

### Carburetors (fig. 28)

This model fits two Dell'Orto carburetors type PHF 36B (D) (right) and PHF 36B (S) (left)

### Controls

- Throttle control grip on the R/H side of the handlebar.
- Easy starter lever for cold engine starts on the L/H side of crankcase.

“A” starting position.

“B” riding position.

### Standard carburettor settings

Choke	ø 36 mm
Throttle valve	60/3
Atomizer	265 AS
Main jet	115
Idling jet	50
Starter jet	70
Pump jet	33
Needle	K 18 (3rd notch)
Float	10 gr

Idling screw adjustment: open 1<sup>1</sup>/<sub>2</sub> turns.



## Adjustment of carburation and Idling Speed

### *Adjust as follows*

1 *Ensure that with starter lever in riding position «B», there is a play of about 3 mm between the cable terminals and adjuster screws «E» for both carburettors.*

2 With the throttle grip fully closed, ensure that between the cable terminals and thumb screws there is a play of 1-1.5 mm for both carburettors.

3 Warm up the engine to its normal running temperature. Screw in fully idling adjusters "C" and then screw them out 1 1/2 turns.

4 Using both your hands, check if the exhaust pipe pressures are equal. If any difference is noted, operate on screw (CD) of one carburettor until the exhaust pressure of both carburettors is the same (idling speed should be kept at no more than 1000-1100 rpm and consequently it may be necessary to screw in the screw of the carburettor for the cylinder giving a lower exhaust pressure, or screw out the screw of the carburettor for the cylinder giving a higher exhaust pressure).

5 Acting on screw "C" get the best carburation for each cylinder (this is perceived by an increase in rpm and then adjust idling speed

As per point 4

6. Disconnect one spark plug lead at a time and check that in both cases the engine stops after firing the same number of revolutions. If it does not, screw out screw "D" of the carburettor making the engine fire more strokes or screw in for the carburettor making the engine fire less strokes.

7 Adjust idling speed at 1000-1100 rpm by screwing in or out screws "D" (both) by the same amount.

S Ensure that the throttle valves open simultaneously by proceeding as follows: "gradually turn the throttle control grip and check that the exhaust pipe pressures increase in synchronization using both your hands (an assistant is necessary for this operation).

If the pressure increase of one cylinder is advanced, act on its carburettor by gradually screwing in cable adjuster until the synchronization of both exhaust pipe pressures is reached.

*N.B. -In order to obtain a correct adjustment of the carburation it is necessary to apply to anyone of our dealers who can carry out this operation by means of a vacuumeter.*

#### 42 Cleaning the fuel tank, fuel taps, fuel filters, and pipes

Every 10.000 km (6000 miles) or in case of irregular fuel flow to the carburettors, it is necessary to clean the fuel tank, fuel taps, filters on carburettors, and the fuel pipes. All these parts are best cleaned with petrol and dried off with compressed air.

Replacing the air filter (fig. 29)



Every 6000 km (3700 miles) check conditions of air filter, if necessary clean it using compressed air; it is advisable to replace it every 9000 km (5600 miles). To replace the air filter lift the saddle, remove fuel tank and side covers. Take out R/H carburettor and undo the screw fixing the air intake to the bike frame; remove the two side screws and take out from the R/H side the container «A» complete with air filter.

## VALVE GEARING

43

Tappet clearance (fig. 30)

After the first 500-1500 km (300-900 miles) and later on after about 3000 km (1800 miles) or so or any time valve operation is too noisy, check tappet clearance.

This adjustment is done with a **cold engine** with the piston at TDC, at the end of the compression stroke (valves fully closed).

After removing the rocker cover, proceed as follows:

1 slacken nut "A";

2 screw in or out adjuster "B" till there is a clearance of 0.22 mm (.0086") for both the inlet and exhaust valves.

This check is made using feeler gauge "C".

In case of higher clearance, there will be noisy valve operation while if the valves do not close fully there will be inconveniences such as:

- compression loss,
- overheating of the engine,
- burning of valves, etc.



## 44 IGNITION

Checking and adjusting the double contact breaker (fig. 31)

### Maintenance

Every 3000 km (2000 miles), lightly moisten cam felt pad "R" with a few drops of engine oil.

- remove the double contact breaker cover, after undoing its securing screws;
- if contacts «A» and «B» are dirty or greasy, clean them with a petrol soaked rag. If damaged or worn, replace them;
- check points gap of breaker «A» (right cylinder - red cable) and breaker «B» (left cylinder - green cable) which should be between 0.37-0.43 mm (0.014-0.016").

### Adjusting the contact points

**Contact «A» ~ right cylinder**  
Bring cam "I" to its maximum lift, loosen screws "C" and "D" and shift plate "E", acting on notch

«F». After setting to correct distance, lock screws "C" and "D"

**Contact «B» - left cylinder**

Bring cam "I" to its maximum lift, loosen screws "G" and "H" and move plate "L" operating on notch "M"

After setting to the correct distance, lock screws "G" and "H"

When adjusting the contact points, check ignition timing as well (see following chapter).

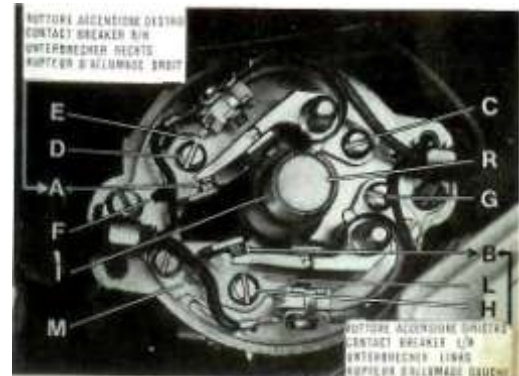

### Inspection

Checking and adjusting the ignition timing "fixed advance" •• (fig. 32)

### Inspection

- remove the rubber cap which seals the inspection hole on the R/H side of the reducer box opposite the flywheel;
- to find the exact moment when points "A" and "B" (fig. 31) start opening, it is advisable to use an appropriate timing light to be set up between the breaker feeding clamp and the ground.

### Timing the right cylinder (fig. 32)

- turn the flywheel counterclockwise [i.e. engine rotation) until the piston is at the end of its compression stroke (both valves closed).

At this stage, mark "D" on the flywheel (TDC for right cylinder) should coincide with mark "1" on the inspection hole rim;

- turn the flywheel clockwise until mark "2" on the flywheel (fixed advance) coincides exactly with mark "1" on the inspection hole rim.

At this point, contact breaker points "A" should start to open (.A" fig. 31).

### Timing the left cylinder (fig. 32)

Turn the flywheel in the normal sense of rotation of the engine (anticlockwise) until the piston is at the end of its compression stroke (valves fully closed). At this point mark "S" on the flywheel (TDC of left cylinder) should coincide with mark "1" on the inspection hole rim.

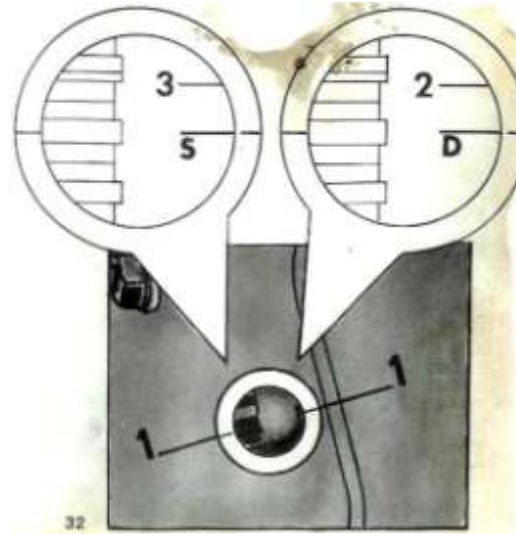

- 46 • now rotate the flywheel clockwise until mark «3» (fixed advance) coincides exactly with mark "1,, on the inspection hole rim. At this point, contact points of breaker «B» "B" fig. 31) should start to open.

#### Ignition advance data

- Initial advance 8°
  - Automatic advance 26°
  - Full advance (l + a.) 34°
- Contact breaker points gap: 0.37 to 0.43 mm (.0147-.016").
- This servicing of ignition timing is best carried out by anyone of our dealers.

#### Spark plugs

The type of spark plugs to be used is: - Bosch W 5 D  
- Lodge 2 HLN Y.

Spark plug points gap: 0.6 mm (.020").  
The spark plug is best cleaned with petrol and a wire brush, using a needle for the inner part.

In re-fitting the spark plugs, ensure they are started by hand for a few turns, completing the operation with the wrench in the tool kit. If not properly

started, the cylinder head thread may get stripped. For all events, the plugs have to be replaced every 9000 km (5600 miles) even if they appear to be still in good condition.

The electrical equipment consists of:

- Battery.
- Starter motor with electromagnetic ratchet control.
- Generator/alternator, fitted on the front end of the crankshaft.
- Double contact breaker with automatic advance.
  - Ignition coils.
  - Rectifier.
  - Regulator.
  - Terminal block with fuses (6 fuses 16 A).
- Flashing light relay.
- Starter relay.
- Headlight
- Tail light
- Turn signal indicators.
- Ignition switch.
- Light switch.
- Turn light switch, horn button, and flashing light
- Engine starting and stop button.
- Electric horn.

### Battery

The battery is a 12 V type with 24Ah capacity and it'll be charged directly by the generator.

Access to the battery is obtained by:

- lifting the saddle by proper hook
- removing the tool box.
- unhooking the rubber bands and disconnecting all electrical cables.

Instructions on how to put a new dry battery in service.

Dry type batteries stay charged for quite a long time, provided they are stored in a cool place ;20-30°C = 60-86 OF) and with their plugs well tightened down.

When putting them in service, activate them as follows:

1 Introduce pure sulphuric acid in the cells with a specific gravity of 1.27 kg/l at temperature of 25°C (77°F) till the level tops the plate separators by 5 mm or up to the level mark.

2 Let the battery at rest for about 1 hour and renew the level with the same type of acid.



48 At this stage the battery is ready to be used. for longer life, it is well to check the acid intensity in each cell. In case of readings lower than 1.26 kg/l, it is necessary to give the battery a refreshing charge to an intensity equal to 1/5th of its capacity is normally sufficient.

Temperature should never exceed 45° C (113°F) but should it go up higher, reduce the current intensity and lengthen the charging time. Stop charging when the specific gravity has gone up again to 1.27 - 1.28 sp, gravity at 25°C and such a rate has remained constant for at least 3 readings at half hour intervals.

Instructions for maintaining acid full batteries

Activated dry type batteries or batteries that have been received already full with acid, should be serviced as follows:

1 Add distilled water (never add sulphuric acid) at least once a month ensuring that the acid level always tops the plate separators by 5 mm (.19").

2 Always keep the battery terminals in a spotlessly clean condition and smeared with jelly.

3 Always keep the top battery cover completely dry, avoiding overflows of electrolyte which will reduce insulation and corrode the battery bracket.

4 Make sure the charging equipment does not give excessive or insufficient charging intensity, bearing in mind that the acid gravity should always be in between 1.24 + 1.27 kg/l. If not it will be necessary to check over the insulation and the efficiency of the charging and engine starting equipment.

5 All acid full batteries that have been stored should be periodically charged at an intensity equal to 1/10th of the capacity and at correct acid level and correct gravity of 1.27 kg/l at 25°C (77 °F).

6 All batteries should be installed on the machine with all retaining devices well tight and with all anti-vibratory devices properly adjusted.

*Note -If the battery is due to be used in tropical climates (average temperature over 35°C) (92 °F) it is recommended to reduce the acid gravity to 1.23 kg/l.*

Light bulbs replacement

Headlight (fig. 33)

To replace the headlight bulbs remove the front cowling, disconnect all rear connections on the headlight, remove rubber cap "G» and take out

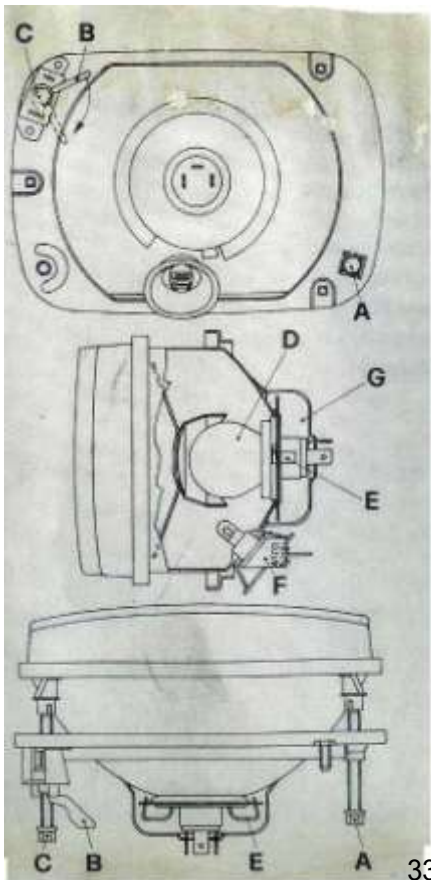

33

4. bulb «D», pressing on spring "E" with a rotary motion,  
 After re-fitting, make sure no other electrical connections have been inadvertently disconnected (especially the position light cable). -' The position light bulb holder «F» is a pressure fit

49

#### Tail light (fig. 35)

Undo screw "A» securing the reflector to the lam'-j. push the bulb inwards, turning it to the left at the same time to free it from the bulb holder.

#### Headlight beam adjustment (fig. 33)

For safe riding and not to trouble crossing riders the headlight has always to be kept at correct height.

Horizontal setting is adjusted by screw "A» while vertical setting is adjusted by "C» until the correct height is reached.

The center of the high beam has not to be higher than 0.833 m (32.79") measured at 3 m distance (abt. 3.3 yards) with the motorcycle off the stand the rider in the saddle.

Acting on lever" B», it is possible to quickly change the horizontal setting to suit it to the load conditions (1 or 2 persons on the saddle).

50 Turn indicators, front and rear 5.  
(fig. 34 & 35)

To remove the turn indicators cups lift them using a screw driver in the points indicated with the arrows  
In the proper hollows have been provided.

*N.B. -For the front indicators it may be necessary to l 1sen screw «B" of fig. 34 and move outward the complete assembly before forcing the cups out with the screw driver.*

Panel, tachometer, rev-counter, voltmeter Take out bulb holders and replace the bulb.

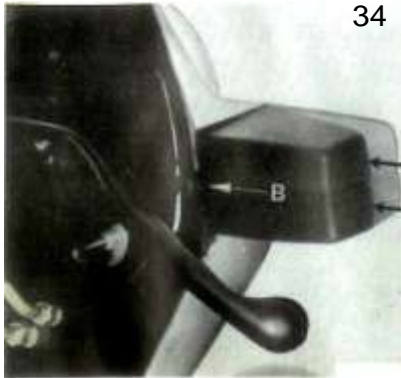

Bulbs

Headlight

- High and low beam 45/40 W  
- Parking light 4 W

Taillight:

- Parking and stop, plate ill. 5/21 W  
Turn signals 21W  
Speedo and rev-counter 3 W  
Panel warning lights 1.2 W  
Voltmeter 3 W

35



## WIRING DIAGRAM

52 Legend electrical wiring diagram (fig. 36)

- |    |  |    |   |
|----|--|----|---|
| 1  | Parking light, front (4 W)                     | 27 | Engine starting and stop button               |
| 2  | High beam bulb (45 W)                          | 28 | Flashing light, turn signals, and horn switch |
| 3  | Low beam bulb (40 W)                           | 29 | Horn  |
| 4  | 3-way connector for headlight                  | 30 | Front brake switch (STOP)                     |
| 5  | (AMP) 4-way connector Molex                    | 31 | Rear brake switch (STOP)                      |
| 6  | 6-way connector                                | 32 | Flashing light relay (FLASH)                  |
| 7  | 7 way connector                                | 33 | Rectifier                                     |
| 8  | Ignition key (3 positions)                     | 34 | Alternator (14 V - 20 A 21)                   |
| 9  | Voltmeter (3 W)                                | 35 | Regulator                                     |
| 10 | Tachometer (3 W)                               | 36 | Battery                                       |
| 11 | Rev-counter (3 W)                              | 37 | Starter motor relay                           |
| 14 | Warning light, right turn signal (1.2 W)       | 38 | Starter motor                                 |
| 15 | Warning light parking (1.2 W)                  | 39 | Terminal block with fuses (16 A)              |
| 16 | Warning light, high beam (1.2 W)               | 40 | Tail light                                    |
| 17 | Warning light, brake fluid level (1.2 W)       | 41 | Rear stop light (21 W)                        |
| 18 | Warning light, oil pressure (1.2 W)            | 42 | Number plate and rear parking light (5 W)     |
| 19 | Warning light, generator (1.2 W)               | 43 | 3-way connector                               |
| 20 | Warning light, neutral position (1.2 W)        | 44 | Flasher box                                   |
| 21 | Warning light, left turn signal (1.2 W)        | 45 | Oil brake level solenoid                      |
| 22 | Switch for simultaneous turning on of Flashers | 46 | Neutral position solenoid                     |
| 23 | Turn flasher, front, right (21 W)              | 47 | Oil pressure solenoid                         |
| 24 | Turn flasher, front, left (21 W)               | 48 | Coils   |
| 25 | Turn flasher, rear, right (21 W)               | 49 | Spark plugs                                   |
| 26 | Turn flasher, rear, left (21 W)                | 50 | Contact breaker                               |



SEIMM MOTO GUZZI S. p. A. Mandello del Lario

Registro secreta Lecce N. 2220

